

The Wireless World

A
PRACTICAL RADIO
JOURNAL
22nd Year of Publication

No. 679.

FRIDAY, SEPTEMBER 2ND, 1932.

VOL. XXXI. No. 9.

Editor:

HUGH S. POCOCK.

Proprietors: ILIFFE & SONS LTD.

Editorial Offices:

116-117, FLEET STREET, LONDON, E.C.4.

Editorial Telephone: 9472 (5 lines).

Advertising and Publishing Offices:

DORSET HOUSE, TUDOR STREET,
LONDON, E.C.4.

Telephone: City 2846 (15 lines).
Telegrams: "Ethaworld, Fleet, London."

COVENTRY: Hertford Street.

Telegrams: "Cyclist, Coventry." Telephone: 5210 Coventry.

BIRMINGHAM: Guildhall Buildings, Navigation Street

Telegrams: "Autopress, Birmingham." Telephone: 2970 Midland (3 lines).

MANCHESTER: 260, Deansgate.

Telegrams: "Iliffe, Manchester." Telephone: Blackfriars 4412 (4 lines).

GLASGOW: 26B, Renfield Street, C.2.

Telegrams: "Iliffe, Glasgow." Telephone: Central 4857.

PUBLISHED WEEKLY. ENTERED AS SECOND CLASS MATTER AT NEW YORK, N.Y.

Subscription Rates:

Home, £1 1s. 8d.; Canada, £1 1s. 8d.; other countries abroad, £1 3s. 10d. per annum.

As many of the circuits and apparatus described in these pages are covered by patents, readers are advised, before making use of them, to satisfy themselves that they would not be infringing patents.

CONTENTS.

	Page
Editorial Comment	223
Oscillator for Ganging	224
Practical Hints and Tips	227
"Wireless World" Baby Superhel ..	228
Olympia—The Trend of Design ..	231
BROADCASTING STATIONS	
ABROAD, pp. I—II	
PROGRAMMES FROM	
ABROAD, pp. III—XXIII	
The Trend of Design (continued) ..	237
News of the Week	245
The Stenode Receiver	246
Curing Hum	249
Letters to the Editor	250
Broadcast Brevities	251
Readers' Problems	252

EDITORIAL COMMENT.

The Trend of Progress.

What We Thought of the Show.

"**W**HAT did you think of the Show?" is a question which has been put to us very frequently in the past few days, and the difficulty is to answer so general a question without getting involved in a discussion of detail.

Perhaps the outstanding impression is that this year's Show has been more a professional affair than ever before. By this we mean that the organisation of the Exhibition itself, the extremely attractive way in which it was laid out, and the products of the new season exhibited at the stands, all bore evidence of what may be described as "professional skill." There seems to have been a pronounced weeding out of wireless sets and components of doubtful merit, and there was very little this year which can be described as "shoddy."

Now that the Show is over, we are confirmed in the impression which we gave previously, that this is to be a "value-for-money" season. Elsewhere in this issue we give a summary of the technical advances which have been made this season, but this report should be read in conjunction with the statement that in practically every class of product shown at Olympia the improvements made in quality of workmanship, efficiency, and general precision of manufacture are at least as great as the progress made in any individual product which, for the reason that it may be a new idea, is apt to attract individual attention.

The gramophone, to be used in conjunction with wireless receivers, has taken its place so definitely alongside wireless this season that it is almost unnecessary to comment on the fact. A better-class wireless set working from the mains is to-day regarded as just as incomplete if it does not provide for gramophone reproduction as a wireless set would have been a year or two ago if it did not cover both long and medium wavebands. Gramophone reproduction is definitely part of the entertainment a wireless set provides.

The high standard which British manufacture has reached this season is something in which we think the industry is to be congratulated. There may be a tendency in the future to bring prices down below their present levels, but if this is done we sincerely hope that it will be in proportion to economies in the cost of production, and that the price reductions should be delayed rather than an attempt made to spoil the product in the effort.

The Amateur's Chance.

A Wireless Auxiliary Reserve.

JUST as we went to press with our issue of last week we were able to include particulars of the inauguration of a scheme under which the Royal Navy invites the co-operation of wireless amateurs in the formation of a Royal Naval Wireless Auxiliary Reserve.

British amateurs, particularly those who have owned experimental transmitting stations, have for many years envied their American colleagues, because in the United States amateurs have for a long while had the opportunity of doing valuable national work as wireless units co-operating with the Government forces. The new British scheme outlined in last week's issue provides for the co-operation not only of transmitting amateurs, but also those who are keen on reception, particularly in connection with short-wave work.

It is expected that it will be possible to obtain a number of special advantages for amateurs who come into this organisation, enabling those not already in possession of a transmitting licence to qualify to obtain one and to make use of wavelengths additional to those ordinarily permitted to the amateur. The Admiralty will, it is understood, undertake to arrange special test transmissions to assist in training. The Radio Society of Great Britain, as the representative amateur body in this country, is taking an important part in launching the scheme.

Amateurs should apply for general particulars of the organisation to the Admiral Commanding Reserves, Queen Anne's Chambers, Tothill Street, S.W.1.

Oscillator for Ganging

A Simple Instrument for Ganging Superheterodyne and Straight Receivers.

THE operation of ganging a receiver, whatever its type, calls for a signal of some kind. Only one signal with a frequency of some 1,450 kc. is necessary for ganging a straight set, but for a superheterodyne signals on 600 kc. and 140 kc. are usually required in addition. Broadcasting stations are usually employed for this purpose, but, although the necessary operations can all be carried out upon them, they are not ideal, since there is always the possibility of fading, giving rise to misleading effects. It would obviously be convenient, therefore, to have a small signal generator for ganging purposes, for it could be adjusted to any particular frequency required, and could be switched on and off as de-

and the variable condenser C_1 . The frequency generated depends upon the coil inductance and the condenser capacity, and, making the centre-tap connection to No. 3 terminal in each case, if a No. 75X Lewcos plug-in coil be used with a 0.0005 mfd. variable condenser, the range of 206 metres (1,455 kc.) to 675 metres (444 kc.) is covered. The substitution of a No. 250X coil changes the range to

the Hartley principle, and the Varley 3-henry tapped choke provides an admirable inductance for this purpose. It is tuned by an 0.05 mfd. condenser, and gives a note of approximately 600 cycles. The H.F. oscillator is modulated through an H.F. choke, a section of the L.F. oscillator choke being included in its anode circuit for this purpose. A switch S_2 is provided to cut out the modulation if desired,

IN addition to providing a source of signals for the alignment of ganged circuits and I.F. stages, this oscillator may be used as a calibrated wavemeter, and as a general-purpose test generator.

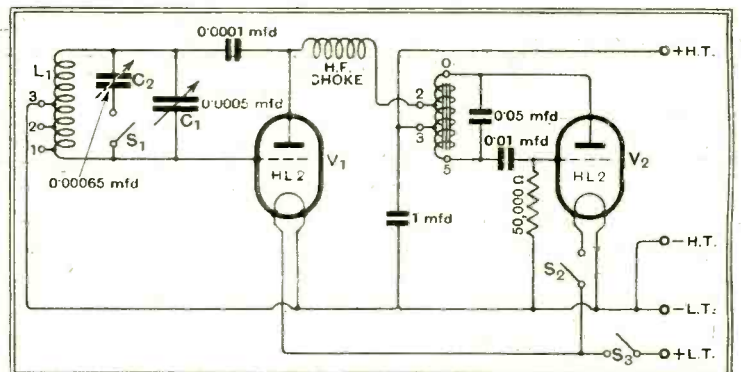
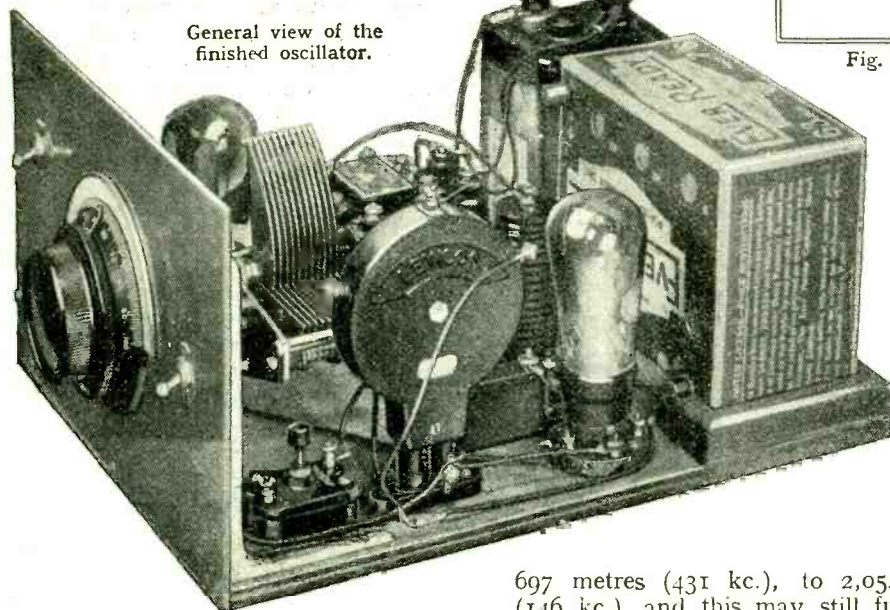

Fig. 1.—Circuit diagram showing values of principal components. C_2 is adjusted to 0.00065 mfd., as explained in the text.

while S_2 switches off the oscillator as a whole. With the Marconi HL2 valves specified, 60 volts H.T. is sufficient, and the output has a good waveform with zero bias in the H.F. oscillator and an 0.01 mfd. grid condenser and 50,000-ohm leak in the L.F. oscillator.

Constructional Details.

A straightforward baseboard layout has been adopted with an aluminium front panel to minimise hand-capacity effects. Since both sides of the tuning condenser C_1 are live, this must be mounted on an insulated vertical sub-panel and connected to the dial through an insulated flexible coupling as shown in Fig. 3. A short $\frac{1}{4}$ in. spindle must be provided to fit the Burndepth dial. The latter is ideal for the present purpose, as the kilocycle separation on the I.F. range can be marked directly on the indicator dial, which will greatly facilitate the estimation of band width when making adjustments.



General view of the finished oscillator.

sired. A suitable type of modulated oscillator is readily constructed, and requires but little apparatus.

The circuit is shown in Fig. 1, and it will be seen that the valve V_2 is connected as a Hartley oscillator with the coil L_1 ,

697 metres (431 kc.), to 2,054 metres (146 kc.), and this may still further be extended to cover the normal superheterodyne intermediate frequency by closing the switch S_1 . This throws a semi-variable condenser C_2 into circuit, which, with a capacity of 0.00065 mfd., allows of a third range of 124.5 kc. to 95 kc. being obtained. The L.F. oscillator V_1 also operates on

Oscillator for Ganging.—

The calibration of the medium- and long-wave broadcast ranges should be made in the usual way from known transmissions. In the case of the I.F. range the reader may have some difficulty in finding the form of the curve for himself. Accordingly, we give the calibration of the original model in Fig. 2. The constants of the Lewcos coils and Cyldon condensers are sufficiently consistent to reproduce this curve with the required accuracy. All that is necessary is for the constructor to adjust the condenser C_2 to the predeter-

required, since the change in H.T. voltage on switching on the L.F. oscillator will slightly affect the calibration.

Perhaps the most general application of this oscillator lies in ganging superhetero-

and including a millimeter in the second detector anode circuit to serve as an indicator. Equally accurate results may be obtained by employing modulation and connecting a valve voltmeter or a suitable copper oxide A.C. meter across the loud speaker.

In the case of a superheterodyne relying entirely upon band-pass filters for the retention of high notes, these may be adjusted accurately with the aid of the oscillator, but an actual indicator is then essential, since the ear cannot be relied upon to distinguish small changes of signal strength. Assuming that it is desired to

TABLE	
K.C. Difference.	Scale Reading.
+10	38.5
5	61
4	64.5
3	67.5
2	70.5
1	73.5
0 (110 k.c.)	76
1	78
2	80
3	82
4	84
5	86
-10	100

Scale readings for marking the indicator scale of the tuning condenser.

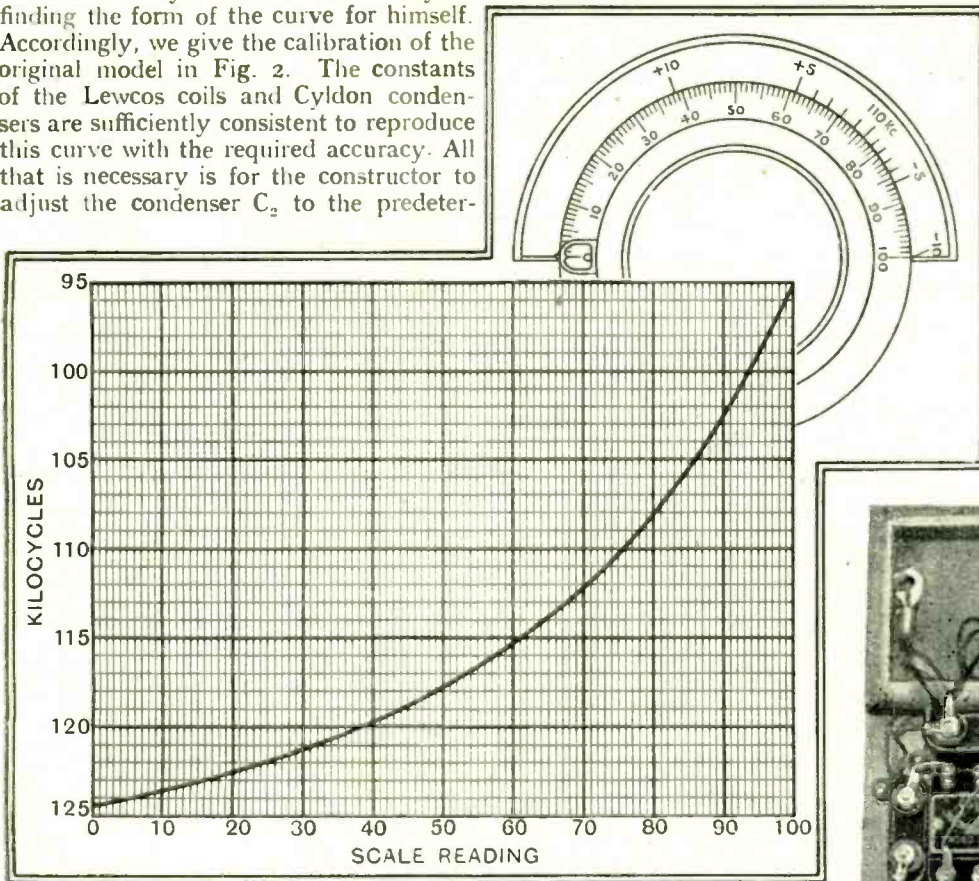
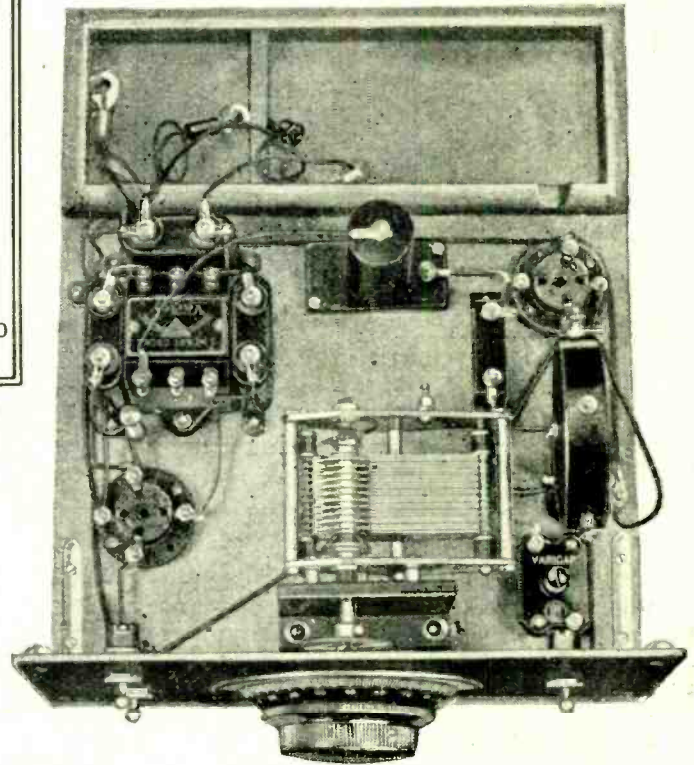

Fig. 2.—Calibration curve of I.F. range showing suggested method of marking indicator scale. A plan view of the oscillator with valves and batteries removed is seen on the right.

mined value. This is easily accomplished in the following manner: Tune in Motala (222.5 kc.) on the receiver and set the oscillator tuning dial to 72.5 degrees on the scale with S_1 closed. Now adjust C_2 until the first harmonic of the oscillator is exactly in tune with Motala's carrier wave. Lock the adjusting screw on C_2 and verify that the setting has not changed, and the curve of Fig. 2 will hold for all practical purposes. This curve was made with the modulator valve switched on, and in the case of the two other ranges the calibration should be made with and without the L.F. oscillator where accuracy is

dynes, and it offers the by no means inconsiderable advantage over normal methods that the I.F. circuits can be adjusted independently of the frequency changer. The oscillator should be set to generate 110 kc., and the oscillator valve of the superheterodyne should be removed, or otherwise prevented from oscillating. It is next necessary to couple the modulated oscillator to the I.F. circuits, and if these be already approximately in tune, it may suffice merely to place it near the first detector. If greater coupling be required, however, this may be obtained by connecting one of the spareappings on the oscillator coil through a condenser to the anode, or even the grid, of the first detector.



adjust the filter couplings to pass a band of frequencies up to 5,000 cycles on either side of resonance, the couplings should be adjusted so that rotating the oscillator condenser between 114 kc. and 106 kc.—that is, 64.5 degrees and 84 degrees—makes no appreciable difference to the reading of the second detector milliammeter or other indicator. The further movement of the condenser to cover the frequencies of 115 kc. to 105 kc. will then normally cause a small drop in the reading by an inaudible amount.

Any further alteration to the dial setting, however, should cause a marked fall in the response, and some measure of the adjacent channel selectivity may be obtained in this way. From the point of view of the best quality, it is important not only that the resonance curve be essentially flat-topped, but that it be symmetrical about the resonance position. This

Adjusting Band-pass Filters.

Each circuit in the I.F. amplifier can now readily be adjusted for maximum response, and if the ear be relied upon as an indicator of resonance, then the oscillator will naturally be used in the modulated condition. More accurate results are to be obtained, however, by using the oscillator with the modulator switched off

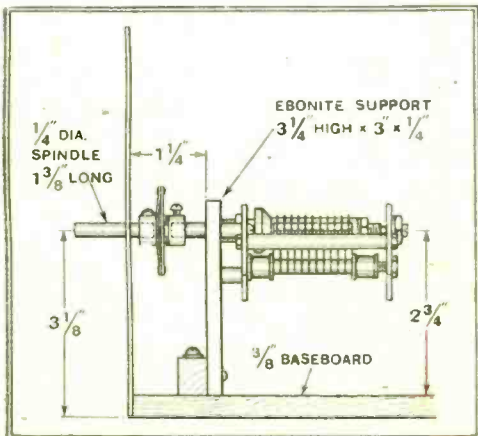

Fig. 3.—Constructional details for mounting the main tuning condenser C_1 .

Practical HINTS and TIPS.

THE design of indoor aerials is not a subject capable of accurate treatment, and most experimenters probably decide finally upon a particular aerial after trial-and-error tests carried out in an empirical manner. The system of aerial comparison described in this note should prove helpful in such experiments.

Aerial Comparisons.

The apparatus required consists only of a semi-variable series aerial condenser and a volume control, both of which components will possibly be in the set used for the tests. If not, they may be connected as shown in Fig. 1.

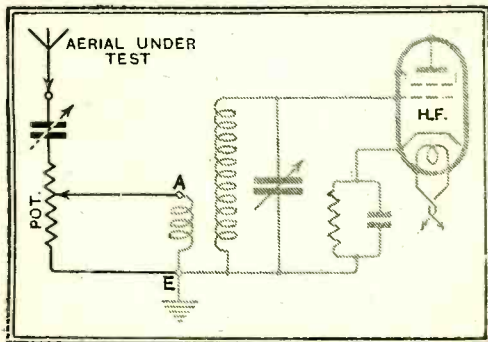

Fig. 1.—To avoid the need for reliance on memory; a simple method of comparing the relative effectiveness of different aerials.

The procedure is as follows: First, connect an aerial to the set through the condenser C, and adjust C for optimum signal strength, tuning the set very carefully. Then reduce the volume control until inaudibility is just reached. Note the volume control setting, which will give an indirect and reciprocal indication of aerial efficiency.

The comparisons should be made at a number of wavelengths, and items such as speech or a tuning note should be selected in order to ensure a reasonably constant input. Further, the comparisons should be carried out during a short period of settled atmospheric conditions, preferably in broad daylight.

IN the interests of simplicity, an aerial-input tuner is often arranged as in Fig. 2 (a). The chief advantage of this scheme is that wave-range switching may be effected by a single switch of the simplest possible "on-off" single-pole type.

Aerial Tuning Systems.

Although generally satisfactory enough in practice, this simple system of waveband switching has the disadvantage that the proportion of aerial capacity that is transferred to the tuned circuit is not the same on both wavebands. On the medium band, if we assume that the aerial tapping on the medium-wave coil L is made at such a point that one-third of its total number of turns are included in the aerial circuit, the transferred capacity will amount approximately to one-ninth of that of the aerial system. But, on switching over to

AIDS TO BETTER RECEPTION.

the long waves, practically all the aerial capacity will be transferred, as the inductance of L is very small in comparison with that of L₁ (the long-wave coil). In effect, on the long-wave side, the aerial capacity is in shunt with practically the whole of the winding.

This difference in transferred capacity is only likely to give real trouble in the case of a set with ganged tuning; it may be avoided by the fairly obvious expedient of fitting a change-over switch in the aerial circuit (Fig. 2 (b)), matters being so arranged that sensibly the same proportion of the total turns of the tuning coils are included in the aerial circuit on each waveband. The disadvantage of this scheme is that a double-pole switch is required, and this is not always easy to devise when it is to be built into the tuning-coil unit. Sometimes it will be simpler to introduce the apparent complexity of separate aerial windings (Fig. 2 (c)); so that the operation of wave-range switching may be carried out by simple on-off switches. Again, to ensure an equal transference of capacity on both bands, the ratio of transformation should be the same for each.

The long-wave aerial winding, which is necessary for the preceding arrangement, may be obviated by adopting the form of connection shown in Fig. 2 (d), where auto-transformer coupling is used on the long waves. Lastly, there remains the very

IN dealing with A.C. mains receivers there is no especial need to be parsimonious in the matter of H.T. voltage, as a little extra pressure may always be obtained by increasing the step-up ratio of the power transformer, and, perhaps, changing the rectifier.

Saving H.T. Volts.

But when it comes to designing sets for D.C. supplies there is a very different story to tell. Here the supply voltage is inexorably fixed at the pressure of the mains, and it can only be increased by the use of a rotary converter or similar appliance. Indeed, the usual course adopted by those who require an exceptionally large output from their amplifiers is to use one of these machines.

For the benefit of those—and they form the great majority—who must limit themselves to the voltage of the supply system, it may be emphasised, therefore, that H.T. volts should be regarded as precious. Although one can hardly advocate battery bias nowadays for the general run of wireless users, there is no objection to a saving being effected in this direction by the knowledgeable wireless amateur, who will appreciate the need for occasional checking of the bias battery. Of course, the H.T. voltage is reduced by the amount of grid bias when any "automatic" scheme is employed.

Another saving can often be effected by using a specially good smoothing choke of adequately high inductance, but with a low D.C. resistance. Chokes of this type are usually designed for high-power A.C. "quality" amplifiers; they are physically

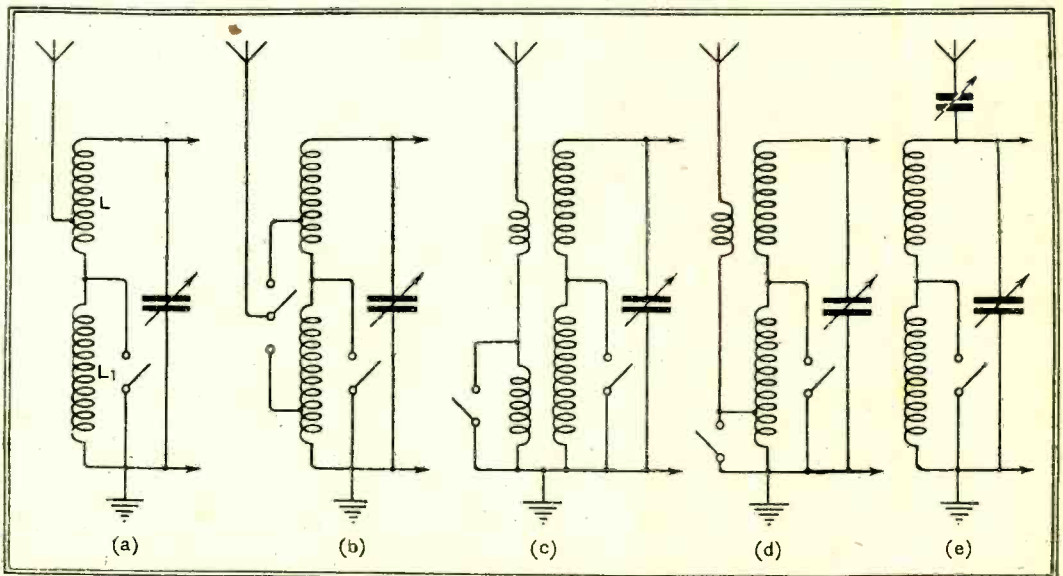

Fig. 2.—In a receiver with ganged tuning it is of some importance that a similar proportion of the aerial capacity should be transferred to the tuned circuit on both wavebands. With the exception of the first, all these input tuning arrangements may be made to satisfy this requirement.

simple—but often very satisfactory—expedient of joining the aerial through a very small condenser directly to the high-potential end of the winding, as shown in Fig. 2 (e). This is equally free from objections on the score of capacity differences.

considerably bigger than the average types, and are also rather more costly.

The difficulty of obtaining enough detector anode voltage (for power-grid detection) can sometimes be overcome by using choke coupling, or by substituting a diode.

Wireless World Baby Superhet.—

and quality can be finally made. It will usually be found that this occurs when the couplings are made slightly tighter than the optima for sensitivity.

A general test should then be carried out on signals, and if all be found in order the set can be finally fitted to the cabinet. This should present no difficulty, but the method of fitting the dial may not be quite clear, since it is screwed to the panel of the cabinet. The vanes of the gang condenser should be fully in, and the dial should be set on its spindle so that when it is vertical it reads exactly 100 degrees and the front edge of the nut on the one-hole fixing bush is exactly flush with the front of the chassis; the set screw should then be tightened up.

The set may now be inserted in the cabinet, and the one-hole fixing bush worked through its hole and the nut run loosely on. When the set is fully home the upper bolt through the escutcheon should be screwed up tightly into the upper rod on the dial, after which the main fixing nut can be tightened up. The knobs can then be placed in position, and the fitting is complete.

Performance on Test.

The set has been thoroughly tested at a distance of nine miles from Brookmans Park with an outdoor aerial of average efficiency. Langenberg, Brussels, Hilversum, North Regional and National, Huizen, and Radio-Paris can all be received at excellent strength in daylight, and dozens of stations are available after dark. The selectivity is barely sufficient to allow of the reception of Koenigswusterhausen when both Daventry and Radio-Paris are working; the station is audible, and its programme can be followed, but complete freedom from interference is hardly to be expected.

On the medium waveband, Algiers and Barcelona, which are spaced by 18 kc. on either side of London Regional, can just be received without interference. Throughout the remainder of the waveband, stations spaced by the standard 9 kc. can be received without mutual interference other than occasional traces of sideband heterodyning. The usual whistles are found at the two points corresponding to second-channel interference from the two London stations, but the numerous whistles associated with early superheterodynes are quite absent.

The quality of reproduction reaches a high standard, and that from the more important of foreign stations is equal to that given by the local, so that in spite of the smallness of the set foreign stations are quite capable of providing programmes which are of entertainment value. The bass is well reproduced, and audible frequencies up to 5,000 cycles are well in evidence while the volume obtainable is ample for the average modern room.

It will be seen, therefore, that as regards sensitivity and quality this receiver will offer a performance equal to, or better than a good straight three-valve set, while its selectivity is enormously superior. Its

selectivity, in fact, is such as to remove entirely the blanketing effect of a powerful local station and to permit of good foreign reception under the very shadow of its aerials.

For the convenience of readers constructing this set, blue prints are available from the Publishers at 1/6, post free.

In conclusion, some remarks as to permissible variations from the specification may be of interest. In the matter of components little latitude is permissible, and the real possibilities are chiefly in the matter of fixed condensers and resistances.

DISTANT RECEPTION NOTES.

IS it worth while yet to think about long-distance reception? If so, at what time of day can one switch on with any hope of success? What Continental stations are coming in well just now? Is there much interference on the long- and medium-wave bands? Are atmospherics troublesome? When they are, can anything be done to minimise the interference that they cause? Can reproduction of really good quality be obtained from foreign stations? If it can, which are the stations most likely to enable it to be done?

It is with these and similar questions affecting the interests of the long-distance enthusiast, whether old hand or beginner, that these notes will deal week by week. I want to make them really useful to readers, and I shall therefore welcome both criticism (preferably of the constructive kind!) and reports upon the reception of foreign stations in different parts of the country. Communications should, if possible, reach *The Wireless World* not later than the first post on Monday mornings.

Signs of the Times.

Looking back over the pages of a long-distance log that covers many years, it is most interesting to notice the way in which the change from summer to winter conditions takes place. Sometimes the process, which chiefly affects stations on the 200-550 metre waveband, is a gradual one; so gradual, in fact, that there is hardly any perceptible difference between one evening's results and those of the preceding evening. More often, though, the change takes place in a series of well-marked steps. For no apparent reason there is a sudden noticeable increase in all-round signal strength on a certain night. This may be maintained, or may be followed by a slight falling off; but presently another increase takes place, and they follow one another at intervals. One of these sudden advances occurred on July 24th, a remarkably early date. On that evening stations such as Budapest, Vienna, Berlin, Witzleben, and Hamburg, which had not been well heard for many weeks suddenly reappeared, and greater volume was obtainable from the majority of European stations. This improvement is still maintained.

Long-wave Stations.

The long-wave band between approxi-

With regard to the former, it is important to note that in certain cases non-inductive condensers must be used, but in others almost any type is suitable. Surprisingly enough, rather more latitude is permissible in the valves, for almost any type of indirectly heated pentode may be used for the output stage, and the Mazda AC/Pen, the Marconi-Osram M.P.T.4, and the Mullard Pen4V are all equally suitable. Again, in the case of the detector the Mazda AC/HL, the Marconi-Osram M.H.4, and the Mullard 354V. valves may be regarded as interchangeable. Even in the variable-mu stage the Mazda AC/S1VM may be substituted for the V.M.S.4. The frequency changer is the most critical, as one might expect, and of those tried only the Mazda AC/Pen. and the Marconi-Osram M.P.T.4 have been found suitable.

mately 1,000 and 2,000 metres contains a good many high-powered stations, a large proportion of which have been well received in this country right through the summer except at times when atmospherics were violent. Long-wave broadcast transmissions are much less affected than those on the medium-wave band by conditions of daylight and darkness, and at all times of the year this band is the happiest hunting ground when daylight reception is required. The long waves have their own crop of curiosities. Lahti, for instance, though rated at 54 kilowatts, is seldom heard at good strength except in the northern parts of this country, though Kalundborg, a mere 7.5-kilowatt station, is pretty reliable at any time when it is in operation, even in southern England. One would hardly suspect from the volume that it provides that Huizen has only 8.5 kilowatts at its command against the 75 kW. of Radio-Paris. The pick of the long-wave stations at present are Huizen, Radio-Paris, Zeesen, Warsaw, Motala, and Kalundborg. Both Warsaw and the Eiffel Tower suffer at times from heterodynes due to Russian transmissions.

On the Medium-wave Band.

A few stations with wavelengths between 200 and 550 metres are to be heard in daylight—Brussels No. 1, Langenberg, Hilversum, Rome, and Trieste are the most likely—but it is at about seven o'clock in the evening just now that medium-wave stations begin to come in really well. Though it is then still broad daylight, the number receivable at good strength is remarkable; there were many more stations to be heard at seven o'clock in the evening during the summer of 1932 than there were at the same time in winter but a year or two ago. As is to be expected, it is the bigger stations that are most reliable early in the evening, and amongst the best heard at the present time are Brussels No. 1, Langenberg, Beromunster, Rome, Toulouse, Strasbourg, Brussels No. 2, the Poste Parisien, Hilversum, Heilsberg, Turin, and Trieste. These dozen stations by no means exhaust the list. As darkness draws on the number of stations receivable increases rapidly, and by nine o'clock one has on the average well over a score of alternative programmes from which to choose.

D. EXER.

- THE TREND of PROGRESS -

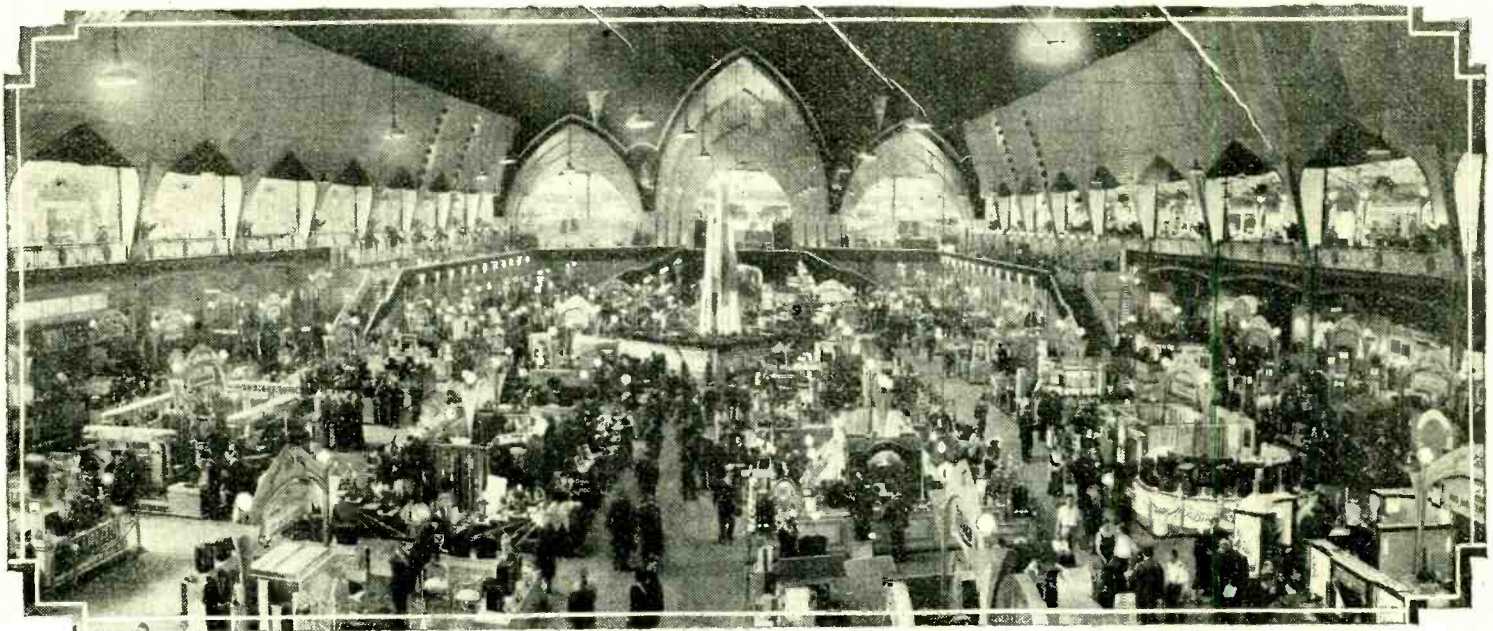

What Olympia Revealed.

IN the pages which follow, the technical staff of "The Wireless World" give a considered account of the new season's wireless products revealed at the show, illustrating and describing the special features of those exhibits which appeared to be of outstanding technical interest or representing new trends in design. The items selected do not, of course, include everything under the above category but may be taken to be typical examples.

IT is common knowledge that the Olympia Exhibition which ended last week was the largest that has ever been staged in this country; of more importance than mere bulk is the fact that it will generally be admitted by now to have been the best. Receiver design has reached such a state of stability that manufacturers can concentrate upon those minor improvements which, in the aggregate, make all the difference between a pleasing set and one which is either a continual source of dissatisfaction or, at best, about which the owner can never be more than lukewarm in his praises.

The tendency towards a self-contained set, with built-in loud speaker, which was well marked last year, has now become established practice, and, so far as the ordinary domestic receiver is concerned, a set without a loud speaker is difficult to find.

With regard to general circuit arrangements, the three-valve H.F.-det.-L.F. set maintains its ascendancy, but the superheterodyne continues to gain ground in the long-range field, largely at the expense of multi-stage H.F. circuits. Detector-L.F. two-valve combinations are as popular as ever for short-distance work.

Turning to matters of detail design, the ordinary screen grid H.F. valve has been largely replaced by the variable- μ type, for reasons that will be well known to our readers. The most important change with

New Receiver Designs

regard to the detector is the well-marked tendency to use screen-grid valves; for instance, no other type of detector is employed in the new G.E.C. sets. Screen-grid valves are more expensive than triodes, but, as detectors, offer the advantages of increased sensitivity, better ganging, and less damping.

As a rule, the S.G. detector valve is coupled to the succeeding L.F. or output valve by means of a resistance-fed transformer, but in not a few cases a simple resistance-capacity coupling is employed.

Pentode versus Triode.

It would be a slight exaggeration to say that the pentode output valve is now universal, but at any rate it is very widely used, and a triode was seldom to be found, except in super-power "quality" sets, particularly those of the type designed for specialised requirements. With regard to the power rectifier of A.C. sets, Westinghouse metal units are being used in increasing numbers.

There was a noticeable tendency at

Olympia towards the use of slightly better coils, and several manufacturers ascribe the improved performance of this year's models almost entirely to improvements in this direction. An outstanding example of this tendency is the Philips receiver, where the coils are obviously regarded by the makers as being of prime importance. The designers of the Marconiphone sets have been able to improve the efficiency of their H.F. windings, and an example of bigger coils was also seen in the new Tunewell radio-gramophone.

But it must not be thought that designers have returned to the bulky and unwieldy windings of a few years ago; in general, the diameter of the present-day coil is seldom more than about 1¼ in., and it seems rather unlikely that windings appreciably larger than the largest of those seen at Olympia will ever be introduced. The need for compactness in the finished receiver is the limiting factor.

Ganged tuning of multi-circuit receivers is practically universal, and even the cheaper sets have seldom more than one tuning control. This applies equally to "straight" H.F. sets and superheterodynes. As a natural corollary, coils are almost always of the "potted" variety, although, for a reason to be explained later, the input windings of some of the new sets are unscreened.

The almost universal adoption of the variable- μ valve as an H.F. amplifier

Olympia.—The Trend of Progress.—

has had the unexpected result of leading to a slight decline in the popularity of band-pass filters in straight sets, and even in the signal-frequency circuits of super-heterodynes.

As to the methods of band-pass coupling actually employed, it was noticed that the double-capacity system is employed in several

Illustrating the revival of interest in coil efficiency; the stranded-wire windings of the new Philips set are larger than usual, and are supported on a glass former.

of the new sets, including those shown by Varley and Tunewell. Link circuit filters or other combinations of inductance

and capacity coupling which give sensibly constant broadness of tuning were much in evidence, while some designers seem still to favour the simple form of filter in which coupling is effected by a large capacity common to both circuits. Simple magnetic filters, with unscreened coils, combined with "potted" intervalve couplings, are quite popular. This practice is exemplified in the Burton and Columbia chassis. The use of a double-tuned intervalve coupling in conjunction with an input filter as an aid to the elimination of interference is to be found in the new Philips and British General sets; the latter is, we believe, the only three-valve set with four tuned circuits.

Manually operated tone controls must not be confused with built-in tone-correction devices, of which the characteristics are fixed. This year there is a very definite tendency towards the inclusion of tone controls in receivers of all kinds. These generally take the form

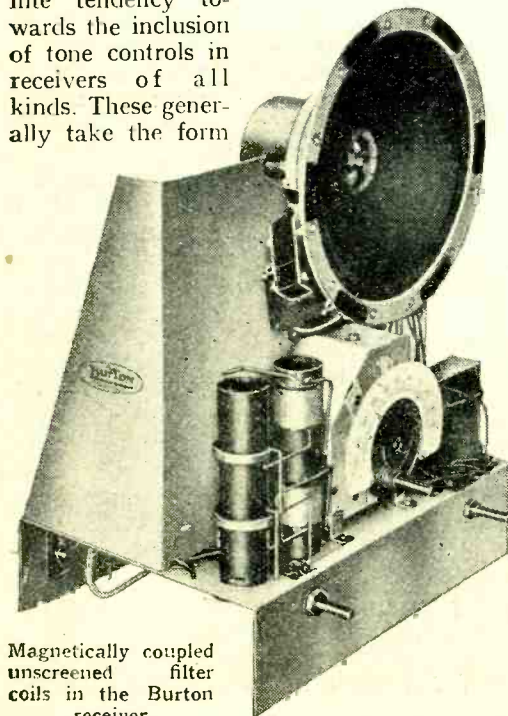

Magnetically coupled unscreened filter coils in the Burton receiver.

of a variable resistance in series with a large-capacity fixed condenser, the combination being fitted in shunt to the loud speaker or an intervalve coupling. In one or two cases, however, a large-capacity variable condenser is used. Such a control, of course, can only reduce the upper frequencies below their normal strength, but this may often prove of advantage when listening to a distant station suffering greatly from interference. The reduction in mush and heterodyne whistles resulting from its use may more than compensate for the deterioration in quality, and give a more pleasing net result.

To Suit all Tastes.

The tone control is usually continuously adjustable, but in some sets it can be thrown in and out by a switch or plug, a method which is adopted in the Umello receiver. For the elimination of high-pitched heterodyne whistles there is a tendency to fit filters, and almost all of the

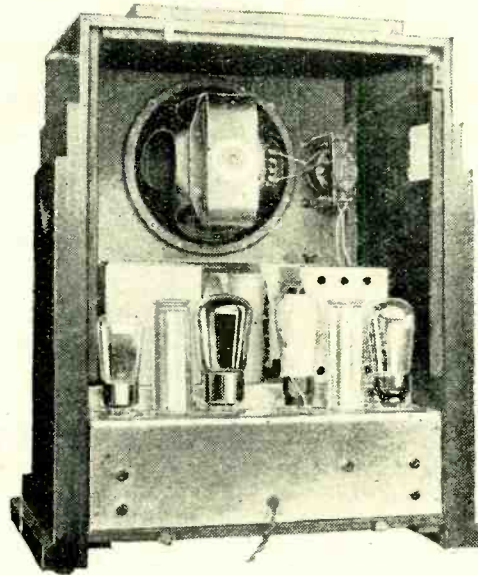

On its specification, the British General receiver should be the most selective three-valve set shown, as it is the only one with four tuned circuits.

G.E.C. sets are so equipped. In some receivers the cut-off frequency is as low as 4,000 cycles, and so removes a certain proportion of the upper musical frequencies; in the majority, however, the cut-off occurs at some 7,000 cycles, and the aim is merely to remove the 9,000 cycles heterodyne note between adjacent stations.

Tone-correction circuits have not been widely adopted, although in many cases a pentode output valve has been selected largely because of the improved response in the upper register which it gives in conjunction with the average loud speaker. Thus it may be said that *automatic* tone correction is quite commonly employed. The use of deliberate tone correctors for accentuating the upper frequencies is almost entirely confined to receivers of the Stenode type, but the R.G.D. model 701 is an interesting exception.

Dual loud speakers, each of which is designed to deal with its own band of frequencies, and for which an exceptional overall combined response is claimed, are to be described under their own heading

later on, but in passing it may be pointed out that the innovation of fitting these instruments into sets is already in evidence. Naturally, there is not room for

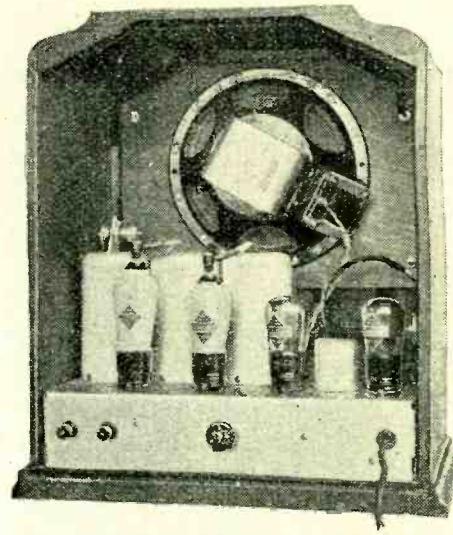

Coscor "2-H.F." battery set, with moving-coil loud speaker.

more than one loud speaker in the average compact "table model," and so we find that the use of two instruments is generally confined to radio-gramophones, such as those produced by R.G.D., Tannoy, Yagerphone, and British General.

Improved Battery-fed Receivers.

The introduction of the better battery set, with a specification that reads like that of a modern mains-operated receiver, is a definite landmark. Some of the sets include band-pass tuning, an H.F. variable- μ valve, and automatic grid bias. Thanks to the use of a high-efficiency pentode output valve, anode current is kept down to a figure in the neighbourhood of 10 milliamperes. Receivers shown by Marconiphone, Sovereign, Six-Sixty, and by several other makers include some or all of these modern features. The new Coscor battery set is one of the few with two H.F. stages and variable- μ valves, but in this instance the designer has wisely considered it to be uneconomical to include automatic bias, as the loss of H.T. voltage would be rather too serious in this case. Even more interesting than the straight sets are the new battery super-heterodynes, to be described later on.

We have slipped rather too easily into the custom of referring to sets as self-contained when they work with an external aerial; practically all the sets so far discussed are of this type, but our excuse must be that most modern mains sets give a performance good enough to satisfy the average user with merely a "mains aerial" connection, which is embodied in nearly all the new productions. Of course, for work at longer ranges an external aerial is desirable. The truly self-contained set, with built-in frame aerial, is not much in evidence, although it has definite advantages to offer to a certain section of wireless users. Notable exceptions are the McMichael and the Pye mains receivers, which are completely self-contained.

Olympia.—The Trend of Progress.—

It is indicative of the present stability of design that details such as tuning dials should be worthy of special discussion. The indicating scale of the typical modern set is roughly calibrated directly in wavelengths, the datum line being so arranged that fine readings are impossible. This is satisfactory enough, and seems to meet with general approval, but it is an undoubted fact that it places difficulties in the way of accurately recording settings for future reference. A notable advance in this direction is made in the new Philips receiver, which carries a triple scale, comprising a rough wavelength calibration, a lettered dial, and a fine vernier scale, which enables settings to be recorded—and made—with extreme accuracy. Instead of “logging” a station at, say, 67½ degrees in the old style, its setting might be recorded on the Philips set as “D.83.”

Improved Indicator Scales.

The long horizontal scale, calibrated as a rule in both wavelength and station settings, is popular; particularly good examples are fitted to the G.E.C. and Ultra sets, although this type of indicator has

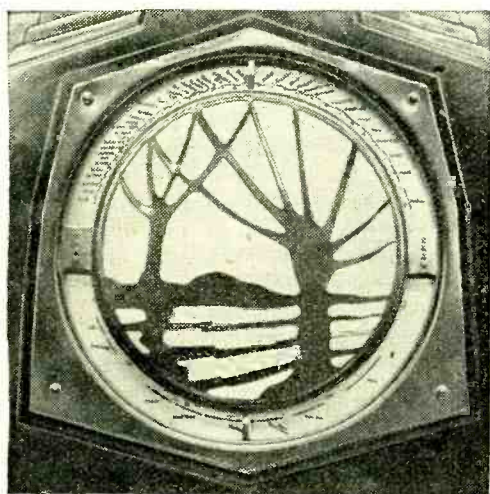

The new large-diameter Ekco station-indicating dial is even more practical than its predecessor.

been abandoned in the latest McMichael receiver in favour of a semi-circular dial with an indicating pointer which is automatically transferred to the “medium” or “long” section by the action of the wave-range switch. A somewhat similar arrangement is to be found in the Marconiphone sets, which include the novel feature of a zero adjuster. The first, and still quite one of the best of the station-indicating dials is the Ekco, which is continued in an improved form. This device owes its effectiveness mainly to its large diameter, which has been achieved without the slightest suggestion of unsightliness by the ingenious expedient of mounting the scale around the periphery of the loud speaker diaphragm.

Technically speaking, the 1932/33 detector-L.F. set is not particularly interesting, except that one finds many

examples which should offer unexceptionable quality combined with a large output. These sets are, of course, intended to satisfy the needs of those who expect to

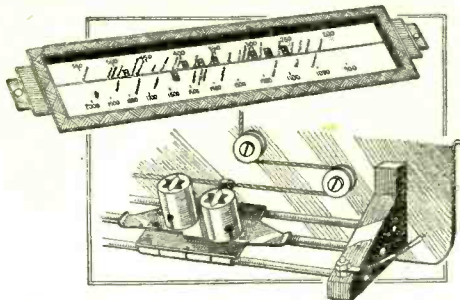

The Ultra station-calibrated scale, and (below) the travelling pilot lights which project a narrow beam of light on the scale.

receive their local stations really well, but practically nothing else. The only drawback is that, under the most difficult conditions, there may be a background of interference; to combat this, one or two receivers—notably the Pye “K”—include a two-circuit tuner. Like all other sets, the new detector-L.F. combinations include a built-in loud speaker, which, in the case of mains-operated versions of all but the least expensive type, is of the moving-coil variety. Cheap self-contained detector-L.F. battery sets are obtainable for as little as £3 upwards, while even great firms like Marconiphone and Columbia do not neglect this field, and produce models at £4 17s. 6d. A good mains set costs about £10—more or less, depending on its output.

The Standard British Set.

The typical H.F.-det.-L.F. three-valve set, which we recently described as the backbone of the industry, has in its cheaper form a single-tuned input circuit, although band-pass filters are included in the more costly models. The H.F. valve is now of the variable- μ type, and is followed by an S.G. or power grid detector coupled by a parallel transformer to an output pentode. The output of this valve feeds a moving-coil loud speaker, of which the field winding serves as a smoothing choke of the H.T. supply. Of course, the tuned circuits, whether there be two or three of them, are gang-tuned, although in the very cheapest sets the tuning system might best be described as of the semi-ganged type, where fairly frequent use of external trimming must be made. As to cost, the two-circuit sets range roughly between 14 and 16 guineas, while those with band-pass tuning cost between 16 and 19 guineas. There are cheaper—and dearer—sets, but the prices given represent a fair average.

Contrary to general expectations, there are a fair number of new “2-H.F.” sets; this in spite of super-

heterodyne competition. These sets should really be divided into two classes. First we have the simple 2-H.F.-det.-output receiver, with single-tuned circuits throughout, which should really be regarded as a competitor of the band-pass set with one H.F. stage, and consequently with the same number of tuned circuits. From most points of view the general performance of the set with the greater number of valves will be better, in spite of the fact that it will be impossible to obtain from it the full measure of sensitivity that would be attainable with a more ambitious tuning system. The manufacturing cost of a set nowadays is largely determined by the number of tuned circuits, and we are assured by manufacturers that there is hardly any difference in cost between the two sets. The Kolster-Brandes four-valve model, which costs only 17 guineas, is an excellent example. The new Cossor Model 533A, also with three circuits and two H.F. stages, is of clean design with individual circuit screening and the universal metal chassis. A triode power grid detector is fitted, and it is coupled to the pentode output valve through a resistance-fed auto-transformer.

Multi-stage H.F. Amplifiers.

In the second category are the four-valve “de luxe” sets with a total of four tuned circuits, of which two are accounted for by the input filter. Thanks to this elaboration, there should be no need to make drastic sacrifices of sensitivity in order to attain reasonable selectivity.

The G.E.C., for the New Viking IV, has adopted the arrangement of four tuned circuits with an input band-pass filter. Again, complete screening is used, but the coil construction is unusual and exceptionally compact. The coils are wound on square formers, and the long-wave windings have slightly smaller dimensions than those for the medium waveband.

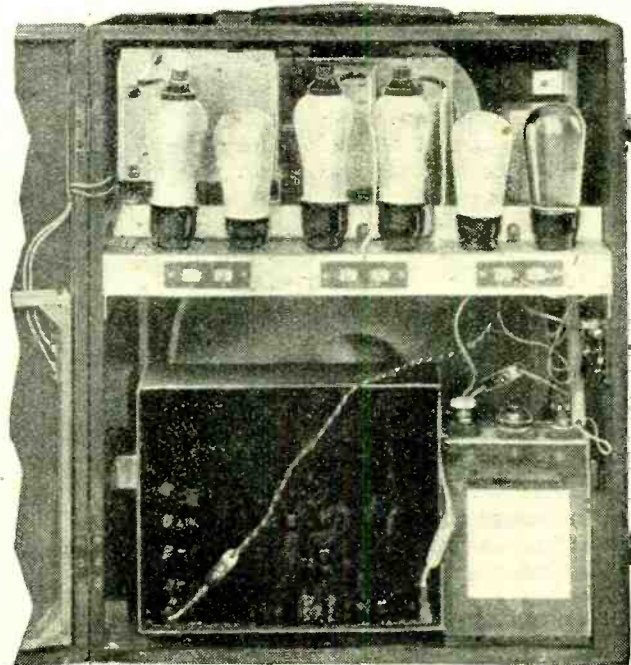

H.M.V. battery-operated superheterodyne portable.

Olympia.—The Trend of Progress.—

The long-wave coils are then fitted inside the medium wave windings, and at right angles so that coupling is at a minimum.

One of the most unconventional of the

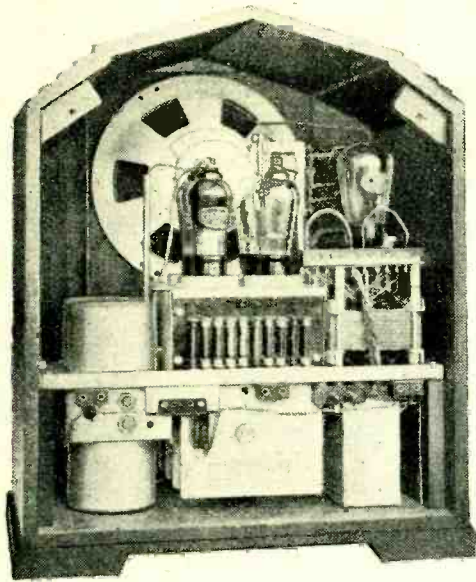

G.E.C. Viking "2-H.F." receiver, with four tuned circuits and a screen-grid detector.

new multi-stage receivers is the Philips Super-Inductance Five; two H.F. stages with screen-grid valves are followed by a detector. A pentode output valve is fitted, and it is preceded by an L.F. stage. Exceptional efficiency is claimed for the coils, which are wound with stranded wire on a glass former. There are four tuned circuits arranged as two double-capacity-coupled band-pass filters; one of these precedes the first valve, while the other couples the first and second H.F. stages. Aperiodic coupling is used between second H.F. and detector valves.

A New "Economy" Idea.

Even more unusual, however, is the same firm's battery receiver. This, again, includes two H.F. stages, but only two tuned circuits are fitted, and the same arrangement of an aperiodic coupling is adhered to. The chief feature of interest lies in the output circuit, in which a pentode is employed. Across the loud speaker is connected a grid rectifier, the anode circuit of which is connected to the automatic bias resistance circuit of the pentode output valve. The pentode is normally biased excessively, so that its anode current is very low. The application of a signal, however, causes the anode current of the grid rectifier, or voltage regulator, valve to fall, and this reduces the bias on the pentode to the correct value for handling the particular signal which is being applied to it.

The net result is that the bias on the

pentode is automatically adjusted to be always as negative as possible consistent with no distortion being introduced. During reception, therefore, the anode current rises above its normal value, and a milliammeter connected in the anode circuits flickers continually. It is claimed, however, that so exactly has the system been worked-out that no distortion is introduced.

Latest Superheterodyne Tendencies.

At last year's exhibition, the superheterodyne appeared for the first time for many years, and although it was well represented, the numbers were negligible compared to those in evidence this year. Almost every stand shows a superheterodyne of some kind, and on many there are several different models. The variable-mu valve is almost universal in the H.F. and I.F. stages, and in a few cases it is to be found acting as a first detector, a function which it will perform quite as well as an ordinary screen-grid type.

Largely as a result of the reduction in cross-modulation, which is found with variable-mu valves, there is a great increase in the number of superheterodynes fitted with signal-frequency H.F. stages. There are a variety of reasons for the use of an H.F. amplifier, of which the least important is amplification for its own sake. By obtaining a moderate degree of amplification at the signal frequency, the ratio of signal to background noise is greatly increased, volume control is simplified and becomes very effective, any tendency towards instability is reduced, and there is less risk of radiation from the aerial.

Again, because of the popularity of

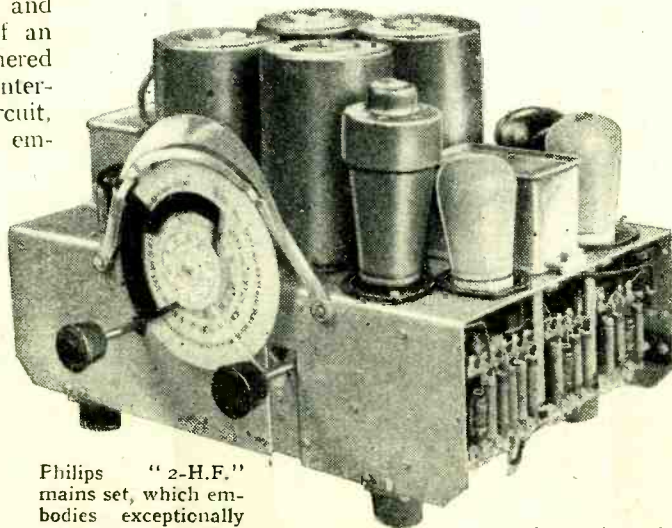

Philips "2-H.F." mains set, which embodies exceptionally efficient coils and a new type of indicator dial with vernier scale.

the variable-mu valve, there is a surprising uniformity in the types of volume control fitted to superheterodynes; there are only two main divisions, which depend on

whether or not the receiver is fitted with a preliminary H.F. stage. When such a stage is employed, the general practice is to control volume by the bias variation of both H.F. and I.F. valves, since this gives a simultaneous control of the amplification both preceding and following the first detector. Where the frequency changer comes first in the set, however, a potentiometer is usually connected in such a manner that one portion of it controls the bias voltage on the I.F. stages, while the other acts as a variable resistance shunt across the aerial and earth terminals to reduce the signal input. The latter method of control is used in the R.G.D. Model 901 receiver, whereas the same firm's Model

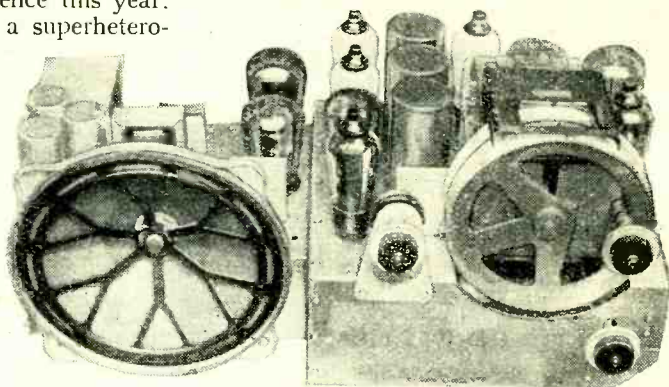

Murphy superheterodyne chassis, of which diode detection and automatic volume control are but two of the many unusual features.

701, which includes an H.F. stage, has only bias voltage control.

Most of the larger receivers are fitted with two stages of I.F. amplification, with six tuned circuits arranged as three band-pass filters, to give very high adjacent-channel selectivity without any serious loss of the upper audible frequencies. Many of these sets also include a single H.F. stage. Where a somewhat smaller set is required it appears to be the general practice to drop one of the I.F. valves and two tuned circuits, but a few cases are to be found where the double I.F. amplifier is retained, and it is the H.F. stage which is omitted.

Unconventional Superheterodynes.

Among the smaller class of five- and six-valve receivers, only one I.F. stage is used, with four tuned circuits arranged as two band-pass filters, and there is usually no H.F. stage. The Ekco and R.I. sets are good examples of this class, and in lieu of an aerial input volume control, the former is fitted with a "local-distance" switch.

Superheterodyne design offers so many possibilities for originality that generalities are apt to be misleading. It is instructive, therefore, to examine one or two receivers in detail. Perhaps the most noteworthy departures from normal practice are to be found in the Murphy superheterodyne, for unusual features are to be found in nearly every stage.

A variable-mu H.F. stage is fitted, and there are three pre-selector circuits. Only a single-tuned circuit precedes the H.F. valve, however, and the other two are em-

Olympia.—The Trend of Progress.—

played as a capacity filter for the coupling between the H.F. and first detector stages, in order to keep background noise at a minimum. The oscillator is the only triode valve in the set, and it has fitted to the reaction coil a resistance-condenser network whose purpose it is to maintain constant output over the tuning range.

Automatic Volume Control.

Two variable-mu I.F. stages are fitted with a total of six tuned circuits, and here the design is fairly conventional, but when we come to the detector we find the most unusual feature of all, for a duodiode is employed. This is exactly analogous to the ordinary full-wave rectifier used in the H.T. supply circuits, and the valve contains two half-wave diode rectifiers in a single glass envelope. The H.F. input is applied in push-pull, so that currents of the signal frequency are balanced out in the output, and little filtering is needed.

A high-resistance load is employed, and with this the characteristics are claimed to be linear for input voltages between 1 volt and 27 volts. The D.C. voltage drop along this load resistance is fed back as grid bias to the H.F., first detector, and first I.F. stage, and a portion of it to the second I.F. stage. Since the voltage thus fed back depends upon the detector input, which in turn depends on the amplification from the early stages, automatic volume control is obtained in an extremely simple fashion.

The L.F. output of the detector is taken through a potentiometer, which acts as

the manual volume control, to the first L.F. stage, where a variable-mu valve is again used. This valve feeds the output pentode through a resistance-capacity coupling.

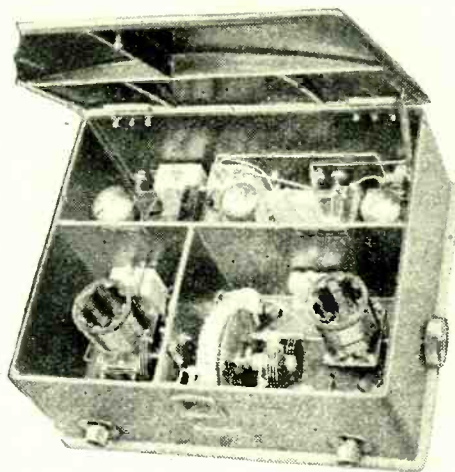

The latest Eddystone All-wave Four : a special "Empire broadcast" receiver.

The H.M.V. superheterodyne has one more valve, because of a push-pull output stage, but in other respects it is totally different. There are three pre-selector circuits with the band-pass filter preceding the variable-mu H.F. valve, a screen-grid anode bend first detector is used, and there are two variable-mu I.F. stages with a total of six tuned circuits. The second detector is a low-resistance valve biased to act as an anode bend rectifier, and it is resistance-capacity coupled to the first L.F. stage, which in turn feeds the output stage through a transformer coupling.

Only two tuned circuits, and no H.F. amplifier, are used in the pre-selector of the R.G.D. Model 901, and the first detector is thus the first valve in the set. It is followed by two variable-mu I.F. stages with which three band-pass filters are associated, a power grid second detector, R.C.-coupled to the first L.F. valve, and then a push-pull output stage. Dual loud speakers are fitted, and their field current is taken from the H.T. supply.

Unlike the previous receiver, the R.G.D. Model 701 includes a shaped-plate type of variable condenser for the maintenance of correct ganging, and a preliminary H.F. amplifier is used with only a single I.F. stage. Variable - mu valves are naturally employed for both stages, and four tuned circuits working as two band-pass filters operate on 110 kc. to provide adjacent-channel selectivity. An anode-bend second detector is used, and this

feeds the output stage through a coupling system specially designed to compensate for deficiencies in the loud speaker and cabinet.

As the cabinet is only of moderate size, its baffle area is restricted, and some loss of bass would normally result. The output valve grid leak, however, is replaced by a choke which resonates with the coupling condenser at about 70 cycles to give an increased response to frequencies of this order. At the very high frequencies the speaker efficiency begins to fall off, and this is corrected for by the inclusion of an air-core choke in the detector anode circuit to make the amplification greater at high than in the middle range of audible frequencies. Thus, although this set includes tone correction, it is not for the purpose of compensating for sideband cutting, but to make up for deficiencies in other portions of the low-frequency apparatus, and it is employed equally on both radio and gramophone.

The New Battery Superheterodyne.

In the field of battery sets, the superheterodyne has long been handicapped by the high current demands of a large number of valves. But decided advances have

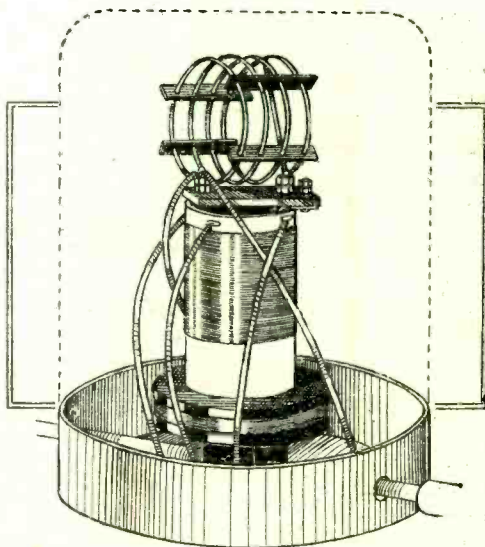

Triple coil assembly of the Pegasus 4-valve set.

been made in this direction, and the six-valve Marconiphone and H.M.V. portables have a total anode current consumption of only 10 ma. These receivers are both of similar type, and a screen-grid H.F. stage is used with two tuned circuits, one of which is the frame aerial, for the pre-selector. A single I.F. stage is fitted, and the triode second detector feeds a low-consumption pentode output valve.

Band-pass I.F. circuits are almost universally employed to obtain high-quality reproduction, and few examples of other methods are to be found, except in tone-corrected sets. The Alba Stenode is interesting on account of departures from normal superheterodyne practice; a very low I.F. is used, and the couplings are not of the band-pass type, since tone correction is relied upon to prevent a loss of the upper frequencies. A true manual tone

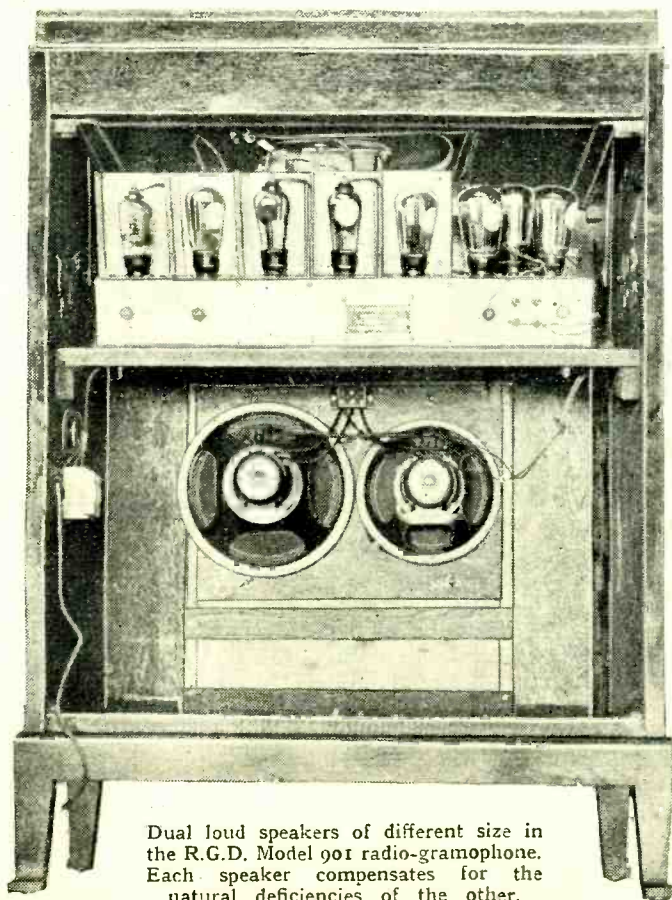

Dual loud speakers of different size in the R.G.D. Model 901 radio-gramophone. Each speaker compensates for the natural deficiencies of the other.

Olympia.—The Trend of Progress.—

control giving alternative attenuation or accentuation of high notes is fitted. The Whitely Stenode is very similar, and includes three pre-selector circuits with a DO/24 output valve.

A feature of the Show was the large number of all-wave sets which in addition to covering the normal broadcast band permit reception of short waves as well. This extension of wave-range was a feature of last year's Kolster-Brandes superheterodyne, and is, of course, continued in the new model. It is also to be found in simpler three- and four-valve sets made by the same firm; in these sets the change-over to the short-wave band is made by plugging in a special coil unit, of which the windings are joined in parallel with those built into the set.

For Empire Broadcasting.

A similar method of changing-over is included in the new two-valve receivers, both for mains feed and batteries, which have just been introduced by Standard Telephones.

The Eddystone All-Wave Four differs from these sets in so far as it is primarily

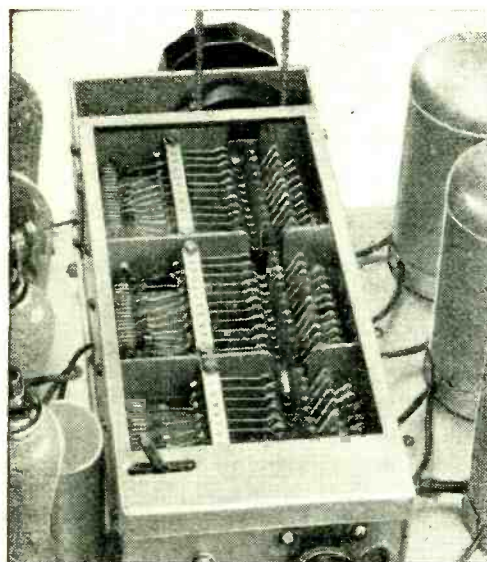

Rotary selector switches and (on left) the tapped air-dielectric tuning condensers of the M.P.A. "automatic" receiver.

designed for short-wave reception, but can be adapted by means of plug-in coils for working on the normal broadcast bands. This set has been redesigned since last year, and now includes a resistance-fed anode supply system and automatic grid bias. While on the subject of "special" sets, it should be put on record that the Eddystone firm produce receivers, either completely made or in kits of parts, for all wavelengths from a few metres upwards.

It was clear that both the sets with "switch tuning" which were shown at Olympia excited the interest which they deserved. Two entirely different methods of control are exemplified; these may be described simply, if rather inaccurately, as electrical and mechanical system. In the M.P.A. Ethatropé, which is electrically controlled, selection is carried out entirely

by a multiple rotary switch, which is arranged to transfer across each of the three tuned circuits the appropriate amount of capacity for the wavelength to be received.

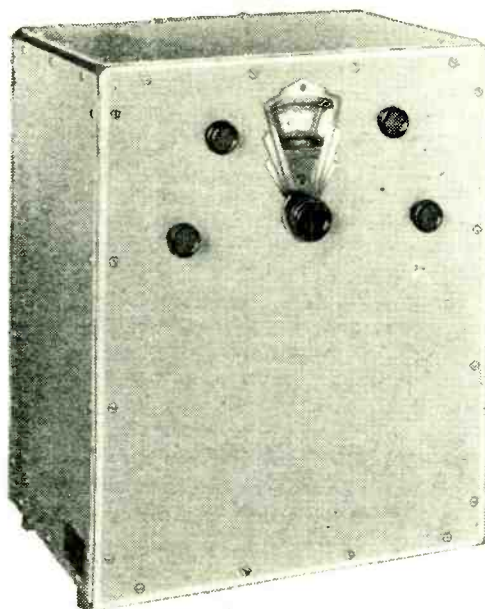

The Haynes Radio Quality Receiver is available in assembled form. This "utility" cabinet consists of metal panels on a chromium-plated frame.

The Zetavox automatic receiver, which incidentally can be tuned in the normal way, embodies a mechanical form of selection, in which depression of the appropriate key rotates the ganged tuning condenser through a rack-and-pinion device to the position of resonance for the station required.

This year's kit sets cover a wider field than ever, all tastes and all requirements being catered for. The latest version of the popular G.E.C. Music Magnet embodies an H.F.-det.-L.F. three-valve combination, with single-tuned circuits, and includes a screen grid detector valve. The set is for battery operation, is self-contained, with the loud speaker, in a moulded bakelite cabinet, and the valve panel unit is supplied ready wired and tested. Among other unusual features is a combined reaction and volume control, effected by means of a potentiometer.

The well-known Cossor Melody Maker kits, with a similar basic circuit, have been redesigned; variable-mu valves are now fitted, and the sets are also available in mains-operated form, and, if required, with a cabinet containing the loud speaker. Peto Scott, who also shows an up-to-date 1-v-1 mains kit, with built-in loud speaker, is also specialising in a range of short-wave

sets, as is the Eddystone Company, whose exhibits have already been mentioned. The "Radio for the Million" organisation has produced a neat little H.F.-detector-L.F. kit, with ganged tuning and magnetic reaction, as well as a mains kit.

The new Ferranti sets for home constructors range from a very simple 1-v-1 combination, with an aperiodic H.F. stage, to an ambitious kit of the 1-v-2 band-pass type. This set, known as the "A.C.12," has band-pass input, and a low-gain intermediate L.F. stage. An output of 12 watts or more is obtainable from push-pull PX.25 output valves. It is stated that this set has a straight line L.F. characteristic between 50 and 6,000 cycles, and that the drop at 8,000 cycles only amounts to 20 per cent.

Both Ready Radio and W.B. showed kits comprising units, rather than components, which could be connected together by the constructor with a very minimum of effort.

Apart from those already mentioned, there are a great number of H.F.-det.-L.F. kits, including one produced by Lissen. But not a few makers seem to prefer the alternative and rather more straightforward arrangement of a detector followed by two L.F. stages, of which a good example is the Lotus. Telsen showed a number of different circuit combinations, and, apart from complete kits, have introduced several innovations which should help to obviate the minor difficulties of the home constructor.

It will be obvious that the straight set still reigns supreme among kit sets, but there is a definite tendency towards the superheterodyne even here. Haynes Radio Single Dial A.C. Superheterodyne kit represents an ambitious type in which the problem of second-channel interference seems to have been successfully tackled; a band-pass pre-selector precedes the two-valve frequency-changer, and a single variable-mu I.F. stage is used with four tuned circuits; a screen grid anode-bend second detector feeds the pentode output valve through R.C. coupling.

This section of our review cannot be

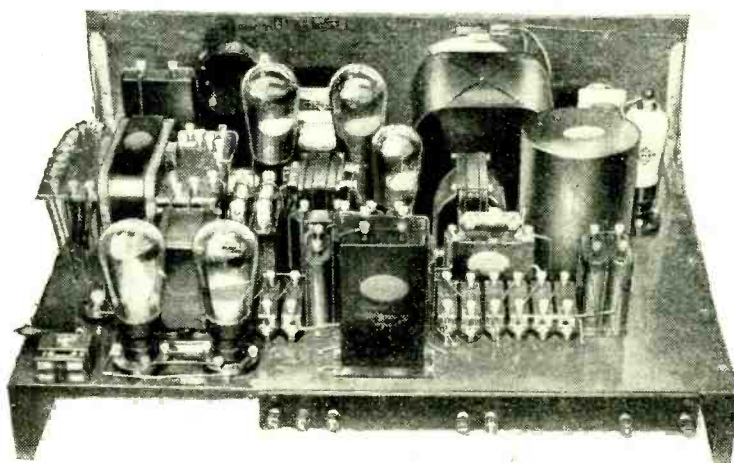

The Ferranti A.C.12 kit, with a 12-watt output.

closed without reference to the workmanlike and obviously carefully designed power amplifier and public-address equipment of Tannoy, Parmeko, and Trix.

Components for the Set Constructor

TAKING into consideration the improvements as well as the many new components that have appeared this year the home constructor is placed in a most advantageous position, for in the main the new models have been designed especially to simplify the work of the set builder. A new development is the composite unit, which, in one

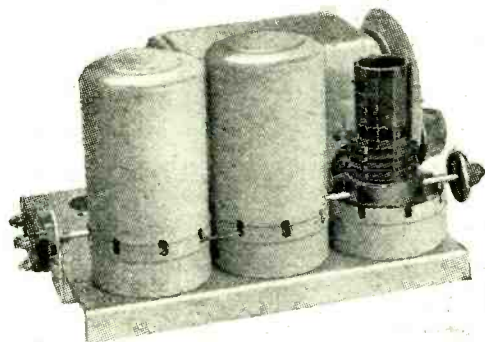

A triple-ganged condenser mounted with dual-wave coils and switching (Colvern).

form, consists of a complete tuning unit comprising a gang condenser and a set of dual-wave coils assembled on a neat metal chassis. Waveband switches are included, while in certain cases a mounting is provided for a volume control. These units bear no relation whatsoever to a kit set, for they are applicable to practically every type of receiver in which screened coils and a gang condenser are used.

A particularly good example is the Colvern ganged triple assembly, which comprises a three-member condenser and three Colvern dual-range coils mounted on a metal chassis with provision for accommodating two valve holders. The three tuned circuits are carefully matched and the only adjustments necessary are those for balancing the incidental capacities introduced by the valves and the additional wiring. A radio-gramophone switch is ganged with the waveband switching for convenience. Since any combination of three coils can be fitted in straight as well as in superheterodyne receivers. A similar unit is supplied by the Formo Co., any combination of coils

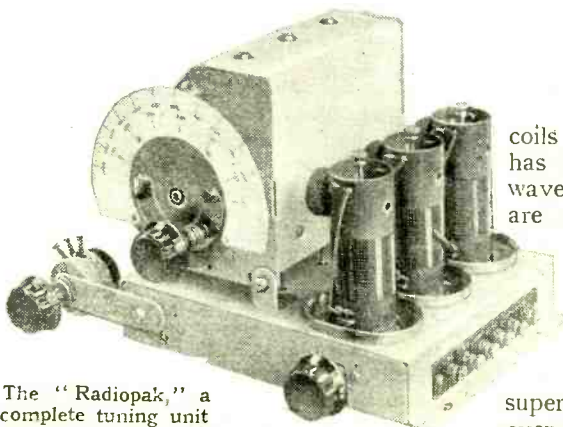

The "Radiopak," a complete tuning unit with matched coils and three-gang condenser.

and condensers is available, but in this model the wiring is left to the constructor.

Another example is the Radiopak, designed by the British Radiophone, Ltd., but here we find rather less latitude in the type of circuit that can be employed. It is intended to form the nucleus of any receiver employing one H.F. stage, and it consists of a three-gang condenser, three screened coils, linked waveband switching and a mounting for a volume control with which can be combined the on-off switch. A wavelength-calibrated scale is fitted and all three controls are arranged symmetrically. An unusual feature of the design is that the band-pass filter is embodied in the H.F. intervalve coupling, while the aerial is loosely coupled to the single-tuned input circuit. The aperiodic aerial coils have been adjusted to avoid break-through of the local station on the long waveband.

Coils and Waveband Switching.

Although the general design of screened coils takes much the same form as formerly, with the small-diameter type predominating, detailed improvements have

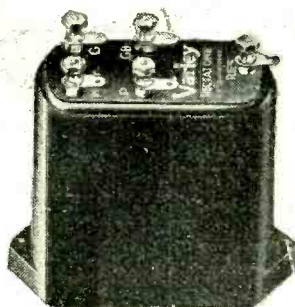

The Varley "Rectatone," a L.F. transformer designed to give a variable amplification characteristic.

been effected and there is now a much wider choice, for the majority of the leading component manufacturers include

coils and band-pass I.F. transformers is probably the most comprehensive of any series now on the market. The band-pass

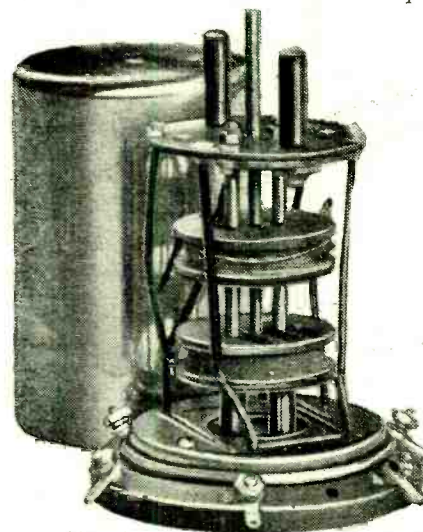

A good example of I.F. transformer for superheterodyne circuits; the Wearite model.

I.F. transformers are all designed to peak at 110 kc., as is the Wearite model, which has external controls.

The new Tunewell coils differ slightly from the majority in that they are enclosed in polished copper boxes somewhat taller than usual. A ribbed ebonite former is employed, and a wide separation is allowed between the sections. Waveband switches are included, and these coils should prove very efficient.

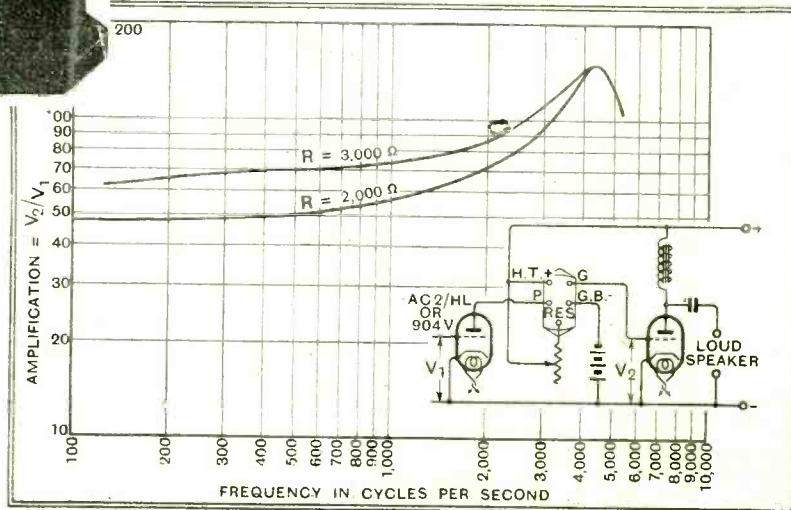

coils of this type in their lists. Telsen has introduced a new series embodying waveband switches, while further examples are made by Igranic, Lissen, Bulgin, British General, and Wright and Weaire (Wearite). The Varley series has been improved and extended, and now includes special oscillator coils, also a band-pass I.F. transformer, for use in superheterodynes. Colvern coils exhibit even a finer finish than hitherto, and with the latest addition of the superheterodyne

So far as ganged condensers are concerned, the latest development is the superheterodyne type. This style was first introduced by the British Radiophone, Ltd., and consists of two or more sections, of which one is fitted with a set of specially shaped stator vanes to give correct tracking of the oscillator and the pre-selector circuits. Accurate matching of the sections is possibly one of the most important of the many improvements made this season. In the J.B. Super-Het Gang series, it is claimed that the dis-

Components for the Set Constructor.—crepancy in the capacities does not exceed $\frac{1}{2}$ micromicrofarad $\pm \frac{1}{2}$ per cent. at any part of the scale.

The Polar "Star" series, in which is included a three-gang superheterodyne type, is of very robust construction, for the con-

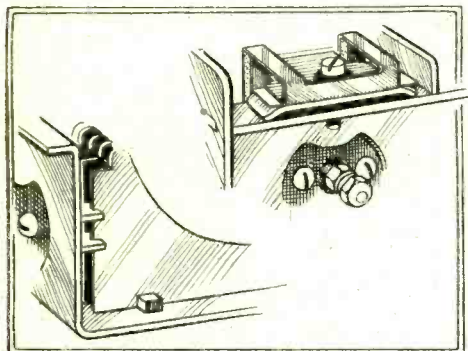

Details of a Polar ganged condenser with easily adjustable trimmers.

densers are mounted in cadmium-plated steel frames fitted with special bearings to preclude end play in the spindle. The matching is carefully executed, and the tolerance is not allowed to exceed $\frac{1}{2}$ per cent. ± 1 micromicrofarad throughout the range of the condenser. A particularly useful feature of the design is that the small trimmers are mounted so that they can be adjusted from the top.

Superheterodyne models are to be found also in the Utility series. For use in "straight" circuits, the choice is now very much wider, since many new types have been developed by the Formo Co., Ormond, Lotus, and Igranic.

Tone Control Units.

Owing to the congested nature of the ether, especially on the medium broadcast waveband, in certain quarters attention is being directed to the use of highly selective H.F. circuits, but followed by a corrected L.F. amplifier to preserve the quality. This has given rise to the development of special coupling devices, in which the degree of amplification can be varied throughout the audible range. The first specially designed transformer to appear embodying these features was

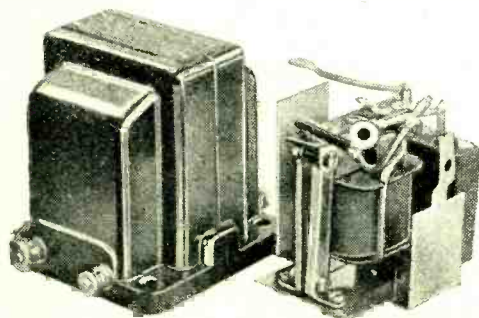

Telsen intervalve coupling unit, designed to have a drooping characteristic making it suitable for use in conjunction with pentode valves.

the Multitone model, and a most instructive demonstration was given at Olympia showing by means of a small cinematograph film the change in the form of its characteristic with various adjustments of the tone control resistance.

This has now been followed by the Varley Rectatone, which is a 1:7 ratio L.F. transformer in which is embodied one of the essential components to provide a variation in its amplification characteristic. It is designed to give compensation for the high-note attenuation concomitant with the use of sharply tuned H.F. circuits, the degree of control being effected by an external resistance.

Tone correction, but in this case of a somewhat different nature, is provided by the Telsen 10-1 intervalve coupling unit. It has a drooping characteristic, that is to say, the higher frequencies are amplified to a lesser degree than those below about 1,000 cycles, the compensation being arranged to correct for the accentuation of the upper register attendant upon the use of pentode output valves. The coupler consists of a resistance-fed L.F. transformer, the primary inductance of which is somewhat lower than usual for components of this type.

Whistle Eliminators.

The elimination of heterodyne whistles may be regarded as an allied subject, for the annoyance is removed by suppressing certain frequencies above a predetermined point in the audible spectrum. So we may include in this category the

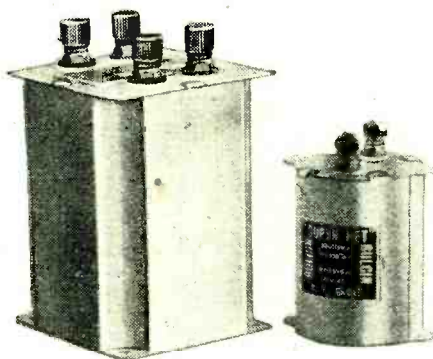

Whistle filter and (right) Super Het H.F. choke by Bulgin.

Bulgin heterodyne-whistle filter, of which there are two types. Model A gives a cut-off at 3,250 cycles, and Model B suppresses all frequencies above 4,750 cycles. While realising that these models cut somewhat deeply into the audible scale, the designers feel that they serve a useful purpose since a 5,000-cycle heterodyne is not uncommon, but should the demand arise for an extension of the range there is the likelihood that further models will be developed.

It will have been noticed that an entirely new style of coupling unit has appeared this year. The component is the logical development of the resistance-fed L.F. transformer, and consists of all the essential component parts embodied in a small compact unit. The Bulgin transformer and the Benjamin Transfeeda, both very aptly named, were ushered in prior to the opening of Olympia, but close on their trail followed three other models, the Formo Multicoupler, the Bowyer-Lowe and A.E.D. model, and the R.I. Para-

feed coupling unit. On the Formo model there are eight terminals which offer a wide choice of connections. It can be arranged as a resistance-fed L.F. transformer with three different ratios, and

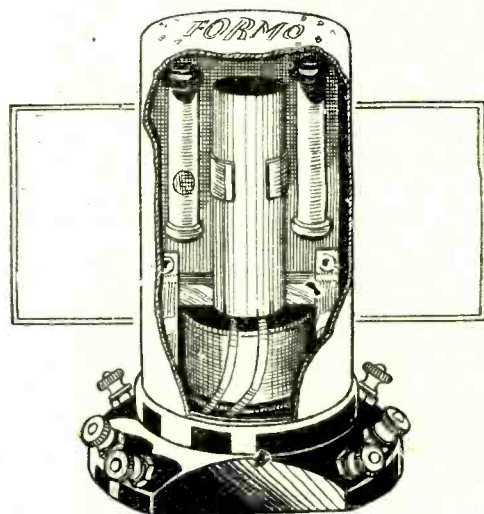

The Formo Multicoupler designed for a variety of coupling arrangements.

since there are two resistances provided various values of anode resistance can be obtained, or one may be used as a decoupling resistance. There are many other possible connections, and this unit should prove very useful in the hands of the experimenter. The R.I. Parafeed coupling unit offers also a multiplicity of connections, for the transformer can be isolated entirely, electrically, from the other component parts, and here again provision is made for obtaining various transformer ratios.

Electrolytic Condensers.

The high-voltage electrolytic condenser which has been in general use for some years in America would seem to have definitely established itself now in this country, for it is undoubtedly one of the most convenient forms for obtaining a large capacity capable of withstanding high D.C. voltages in a small compass. It is available in two styles, an aqueous or wet type, and a dry type. Although the first mentioned contains a free liquid the

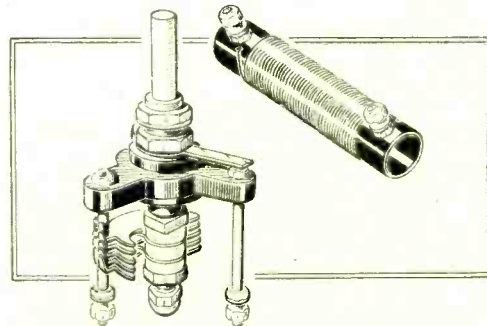

Stratton Microdenser and ultra-short-wave choke.

container is so designed that no leakage can occur, while its main advantage is that in the event of a breakdown, due to exceeding the rated peak voltage, the condenser is self-sealing. It should be noted

Components for the Set Constructor.—

that this particular type of condenser is not suitable for use in A.C. circuits, and, furthermore, it must be connected in the correct manner. The metal container is, as a rule, the negative electrode.

The dry electrolytic condensers do not contain a free liquid, thus it is possible to mount them in any position. The Dubilier series includes dry models which are rated to work at 450 D.C., and in the T.C.C. range there are models of both types, the wet style being rated at 440 volts and 460 volts working, while the dry models have a working potential of 500 volts D.C.

In the Hellesen range there are models of both patterns. The dry series are of interest, for these are made as dual types and as single condensers. The dual series are arranged as 8+4 mfd. and 2+2 mfd., to cite two examples. The container is not the negative pole in this case, but a separate lead is provided. There are, of course, two positive connections. The British N.S.F. Co., Ltd., have a range of dry electrolytic condensers also.

There can be no doubt that our component manufacturers are well abreast of the times, for even at this early date there is considerable interest shown in special components for use on ultra-short wavelengths in anticipation of the inauguration of the much-discussed 7-metre trans-

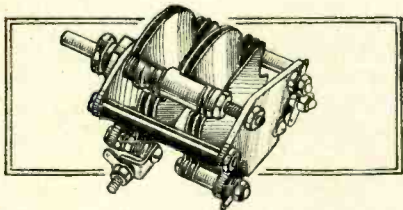

Cyldon series-gap midget condenser.

missions. This calls for a style of component that gladdens the heart of the real short-wave enthusiast, to whom a coil with more than six turns is regarded as a long-wave inductance. The special midget condenser, as exemplified by the Eddystone range of microcondensers, the smallest of which has a maximum capacity of 15 micromicrofarads only, are exceptionally fine examples.

The Cyldon series-gap model has been designed especially for this particular purpose also. In this case there are two sets of fixed vanes, while the rotor is used as a bridge only to vary the capacity, thus avoiding the difficulty of making a good non-inductive and noiseless contact with a rotating spindle.

Low-frequency Transformers.

There is a marked improvement in the quality of the inexpensive type of L.F. transformer suitable for direct feed. The primary inductance is now maintained at a satisfactory level, even when passing as much as 6 mA. of D.C., so that an adequate amplification is assured at the lower frequencies. A notable example is the Ferranti A.F.10 model, which, with 6 mA. of D.C. flowing in the primary winding, shows an inductance of more than 15

henrys. The step-up ratio is 1:3. For this season, practically all the leading component makers, such as Telsen, Igranic, R.I., Lissen, and Tunewell, to mention but a few only, have models of this type.

Resistances, both fixed and variable and capable of dissipating a high wattage,

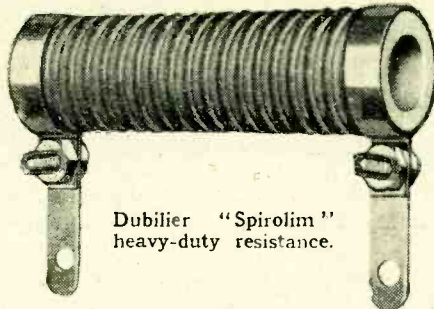

Dubilier "Spirolim" heavy-duty resistance.

have come into vogue during the past year, the more general use of higher anode potentials and larger power valves being the main factors responsible for the demand for this class of component. Variable resistances and potentiometers of from 5 to 10 watts rating followed in the train of variable- μ valves, in connection with which noiseless contacts have been developed, since these often serve as pre-detector volume controls. The Wearite, Varley and Watmel models are cases in point. In addition, provision is now made for ganging two or more resistances with a mains switch.

Mains Apparatus.

Mains equipment must surely be one of the most important sections of the radio industry, for in addition to power amplifiers, which are really in a class apart, there is now a very wide choice of transformers of every conceivable type. Rectifiers, such as the Westinghouse models, have been extended to meet the present-day needs for higher D.C. voltages and heavier currents, and smoothing chokes have had to keep pace with the times, for 100-mA. models are now quite common,

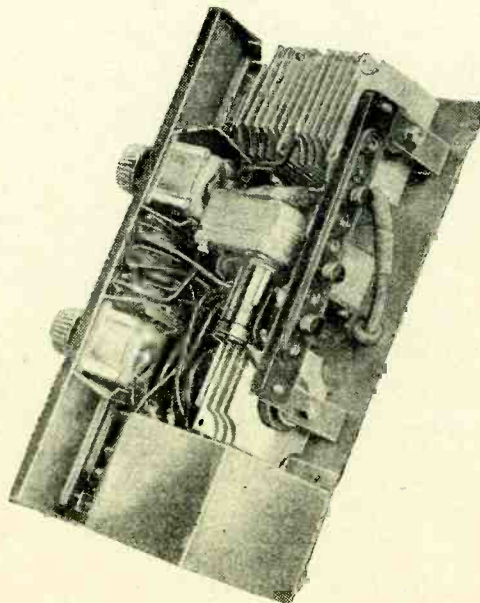

Clarke's "Atlas" A.C. 300 eliminator chassis, showing voltage control resistance.

whereas a year or so ago they were in the minority.

Developments in this direction have been shared in equal measure by so many firms that it would be invidious to single out even a few names for particular mention here.

Refinements in Battery Eliminators.

The only marked change in the design of battery eliminators is in connection with voltage regulation under varying load conditions. Hitherto the D.C. output voltage from tapings not provided with a variable control was governed by the current load, with the result that if the receiver required a few milliamps. only the voltage was often excessively high. In the Clarke's "Atlas" model A.C. 300, there is included a tapped limiting resistance which enables the voltage to be maintained at a constant value even on half the maximum load.

A similar feature is embodied in the new Regentone models, where it takes the form of a tapped "line resistance," by means

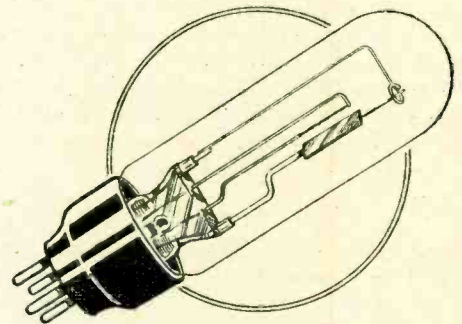

Edison Swan thermal delay switch mounted in vacuo.

of which the output voltage can be kept at a steady value even though the current load varies within quite wide limits.

The Edison Swan Electric Co., Ltd., have developed an entirely new type of thermal delay switch consisting of a bi-metal strip heated by a separate filament and mounted *in vacuo*. It is not affected by atmospheric conditions and possesses the further advantage that arcing at the contacts is avoided.

The smaller models will handle up to 200 mA. and require 4 volts for the heater supply. With 0.5 amp. flowing in the heater circuit the delay period is approximately thirty seconds. There is a larger size available capable of dealing with a current of 5 amps. In appearance these thermal delay switches resemble a tubular valve, for they are fitted with a 4-pin base which fits the standard-type valve holder.

In conclusion, mention must be made of the Burton super-type rotary switch in view of its novel design. This is a most versatile component, for it combines in one unit five separate switches, one of which is intended for interrupting the mains supply. It is a four-position switch, and can be used to short-circuit three separate coils simultaneously in one position, while the remaining three settings provide switching for radio to gramophone and on-off respectively.

Loud Speaker Developments

THIS year's show has established the medium-sized permanent magnet moving-coil loud speaker as the predominant type—at all events from the point of view of popularity. Last year the price of a loud-speaker unit of this type was in the region of £3 10s., whereas at Olympia this year units of at least equal performance were offered at prices ranging from 32s. 6d. to £2 10s. The Amplion MC22, Baker

cuit are provided. The centre pole-piece in the Darwin two-claw magnet is specifically designed to prevent short-circuiting of the comparatively expensive magnetic material, and at the point of contact with the magnet is made long and narrow with this object in view.

specially designed for incorporation in mains receivers or have revised their existing models: Whiteley Electrical ("W. B." EM), Standard Telephones (S.S. 100), Lamplugh (Lektro-Mag), Ferranti (D3), and Celestion (D.8). The majority now fit a "humbucking" coil in the field, connected in series with and in opposition to the speech coil to suppress residual hum. It is common practice to use the field coil as part of the smoothing equipment of the set, and in the case of the Celestion D.8, to mention only one example, full particulars of the induct-

Miniature Moving-coil Units.

The reduction in the cost of magnets has encouraged quite a number of manufacturers to produce miniature moving-coil units, selling for about 27s. 6d., of which the Celestion "Soundex," Epoch MM, Lamplugh Junior, R. & A. "Bantam," and W.B. "Mansfield" may be cited as typical examples. To preserve overall sensitivity some sacrifice of bass response has had to be made, but the range of frequencies covered is equal to that of all but the most expensive moving-iron instruments, and the output in the middle and upper registers is quite up to the standard of the average permanent magnet moving coil. The general practice is to raise the principal diaphragm resonance to about 150 cycles by decreasing its weight and

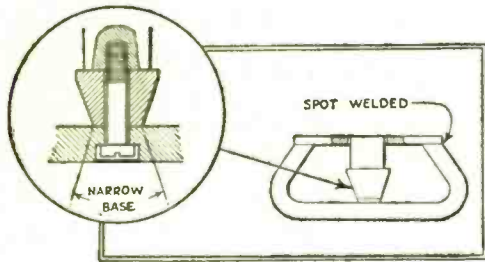

Pole-piece assembly in the Darwin two-claw magnet.

Selhurst "Permag," Blue Spot 99PM, Celestion PPM9, Clarke "Atlas," Epoch 20c, Igranic D.9, Lamplugh P.M., Loewe PML200, Ormond R/475, R. & A. "Challenger," Rola P.M., Sonochorde P.M., Standard S.S.P., and W.B. PM4 are typical examples of this class which have made their first appearance at Olympia.

Two-claw Magnets.

Better control over assembly—a rather delicate process with small air-gaps—is a contributory factor to this wholesale price reduction, but much of the credit is due to the magnet manufacturers, who have developed a new two-claw type which can be very cheaply forged from the bar and is quite as efficient as the previous cast types, assuming, of course, that an equivalent cross-section and length of magnetic cir-

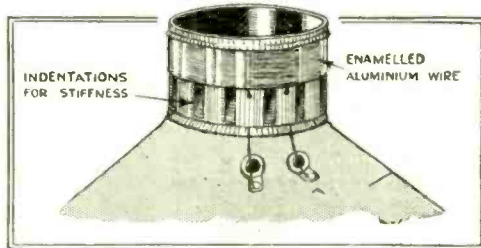

Aluminium wire is used in the speech coils of some Celestion loud speakers.

diameter, and by increasing the stiffness of the surround or the coil-centring spider. Since most of the energy of speech and music is carried by frequencies between 100 and 5,000 cycles the apparent sensitivity is remarkably good and, owing to the restriction of amplitude below 100 cycles, these units will absorb powers of 2 to 4 watts without distress. There can be little doubt that the purchaser of a "midget" unit will be getting excellent acoustic value for his money.

Mains-energised Types.

A noticeably greater number of permanent magnet moving-coil loud speakers are now fitted in self-contained table-type battery receivers, and in the near future it is possible that the balanced armature moving-iron type will be used only in portable sets where weight is an important factor. In mains receivers, of course, the loud speaker, if included, is now invariably of the electro-magnet moving-coil type, and the past year has seen a considerable increase in the demand. In addition to Rola and Magnavox the following firms are now providing units

Swift Levick chrome-steel two-claw magnet as used in the Lamplugh moving-coil loud speaker.



ance of the field under working conditions are supplied. The new Ferranti D3 energised model is notable in that it is fitted with the same type of diaphragm as the well-known MI permanent magnet model.

Mechanical Strength.

It is gratifying to note that the problems of rigidity and the accurate centring of the moving coil in the magnet air-gap have been successfully tackled during the year. In earlier types the relative positions of the diaphragm and magnet were adjusted by hand. The coil frequently shifted out of centre in transit to the set manufacturer, and only the most robust types survived the continuous handling on the assembly and test benches. Nowadays the diaphragms of all the leading makes are jig-assembled in their pressed-steel

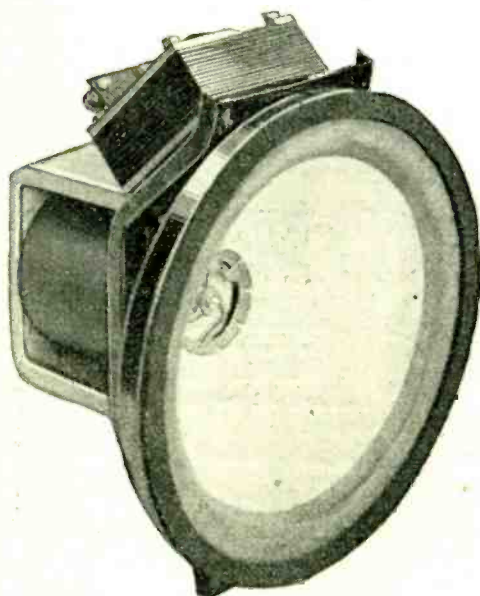

Ferranti type D3T mains energised loud speaker.

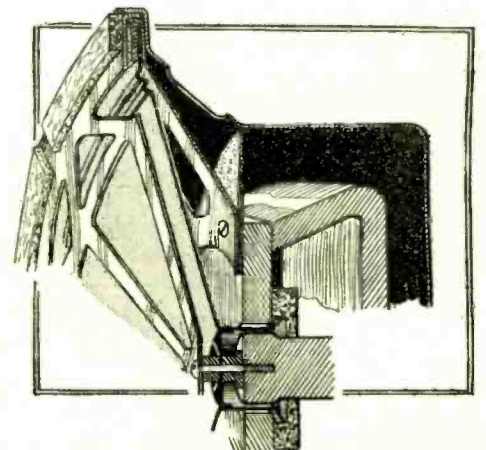

Section of R. & A. "Victor" loud speaker showing protected diaphragm.

Loud Speaker Developments.— housings and are locked on the magnet by raised spigots or concentric shoulders (as in the Celestion D.C. speakers). A pro-

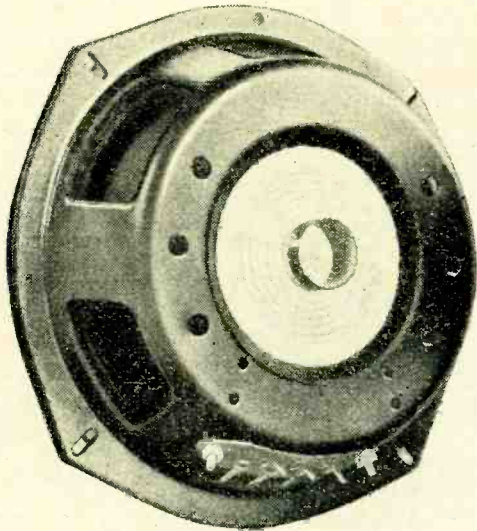

Corrugated centring sub-diaphragm in the Sonochorde loud speaker.

misg method of securing absolute lateral rigidity of the coil without impairing its movement parallel to the axis of the centre pole-piece has been adopted in the Sonochorde loud speakers. Instead of the conventional 3- or 4-legged centring spider a continuous sub-diaphragm of comparatively large diameter is fitted behind the cone apex. Concentric corrugations ensure flexibility in the direction of movement of the coil without permitting the slightest lateral movement. A similar prin-

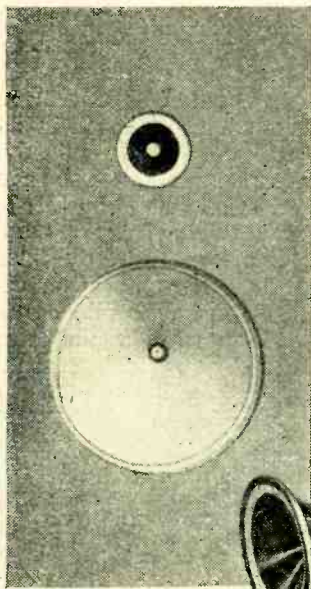

Hartley-Turner "Duplex" and "Standard" moving-coil loud speakers.

ciple is involved in the diaphragm assembly of the new Film Industries type P.A.C. units. In this case, however, the sub-diaphragm is of thin duralumin with a domed centre to which the apex of the paper cone is subsequently fixed by a special glue. Another excellent example of rugged construction is to be found in the R. & A. "Victor." As in the Magnavox units, the front of the diaphragm is pro-

tected by an artistic metal grille. This, together with a chromium-plated diaphragm housing, forms a rigid unit which is accurately aligned and riveted. An outer enamelled casing encloses the magnet and diaphragm assembly, and the holes behind the diaphragm are staggered. This not only prevents damage to the back of the diaphragm but also gives an increased baffle effect which materially reduces box resonance when the unit is housed in a cabinet.

Compensated Dual Units.

Dual-unit loud speakers were a prominent feature this year and have already been taken up by many of the set manufacturers. The principle is not new, and there are several alternative lines of approach. In the majority of cases the idea has been to improve the performance of existing mass-produced units by overlapping the characteristics of suitably matched pairs. When two such units are fitted with slightly different diaphragms to separate the fundamental resonances, and their speech coils are connected in parallel across the secondary of a common output transformer, there is a mutual shunting effect which considerably reduces the diaphragm excursion in the vicinity of resonance. There is also a very definite increase in the true bass between 50 and 100 cycles, while in the upper register,

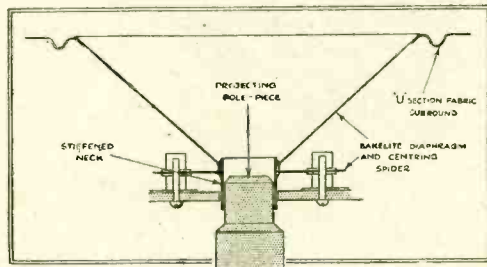

Section of Hartley-Turner "Standard" loud speaker movement.

although the frequency range is not extended, the response is less "peaky." In the Hartley-Turner Duplex loud speaker arrangement, on the other hand, the two units are used to cover a wider frequency spectrum at both ends in addition to providing a greater power-handling capacity. There is a large-diameter cone which handles the bass and middle register, while a very small-diameter cone is provided for the upper register. Filter circuits are incorporated to prevent overlapping and to ensure that the impedance behaves like that of an ordinary moving coil. The frequency range covered is from 40 to 10,000 cycles and the power-handling capacity is 25 watts.

Both units incorporate the constructional principles which have been adopted in the Hartley-Turner Standard loud speaker, which has a remarkably good performance for a single-diaphragm loud speaker. The fundamental diaphragm resonance is below the useful frequency range and the flexible surround and centring spider give freedom of movement for amplitudes of the order of 1/4 in. To prevent frequency doubling and modulation of superimposed

high frequency when the diaphragm is developing large amplitudes the pole-pieces have been shaped to give a symmetrical distribution of leakage flux. The use of a hard bakelite diaphragm gives

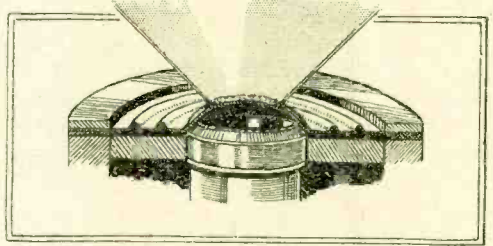

Duralumin centring diaphragm in the Film Industries type P.A.C. unit.

good high-frequency response up to 9,000 cycles, and special attention has been given to the method of fixing the speech coil to the diaphragm to eliminate the resonance at about 3,000 cycles, which is a common fault in moving-coil loud speakers.

Baffle Design.

The Howe box baffle is another development which will interest those in search of the highest possible quality of reproduction. The open-backed box baffle has advantages over the plane baffle board of equivalent area both from the point of view of appearance and rigidity, but has not hitherto met with very wide acceptance for real quality work on account of resonance of the enclosed air which generally manifests itself at about 150. This drawback is completely overcome in the Howe baffle by padding the interior with slag wool in quasi-exponential form, as shown in the accompanying photograph.

In conclusion, mention should be made of the Primustatic loud speakers working on the electrostatic principle and the "Aylesbury-Trouton" moving-iron movements. The former is now available for push-pull working, and the "Aylesbury-Trouton" unit, which is a revised version of the earlier Amplion "Lion" loud speakers, exemplifies the moving-iron principle at its best. The "Eckersley-Trouton" unit handles input powers up to 5 watts and has a full bass response down to 50 cycles.

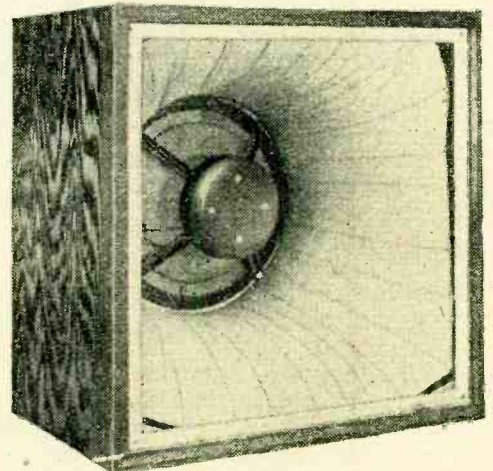

Howe box baffle with slag wool lining.

Gramophone Equipment

THE majority of the new pick-ups are of the customary half-rocker type. The Bowyer-Lowe and A.E.D. Mark III pick-up is notable in that the frequency characteristic has been specially adapted to compensate for 100 cycle and 3,000 cycle resonances

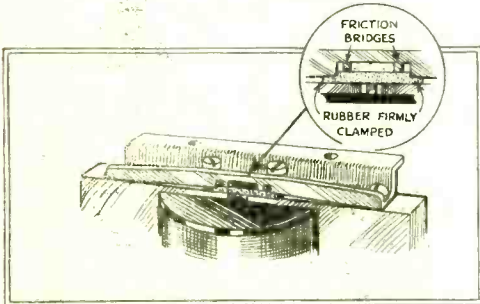

Combined rubber and friction damping is employed in the Bowyer-Lowe and A.E.D. Mark III pick-up.

commonly met with in medium-sized moving-coil loud speakers. The armature and pole pieces are machined to "1/2 thou." limits and an ingenious combination of friction and rubber damping is used to control the armature.

The new K.B.301 Radiophone pick-ups are housed in neat moulded tone arms and the new Harlie Model 65 hinges vertically for needle changing. The British Goldring pick-up is fitted with an edgewise control for the volume control housed in the tone-arm pillar.

Tone Arm Resonance.

A definite trend in the design of pick-ups is the practice of using tone-arm resonance in conjunction with wider air-gaps as a means of obtaining a rising characteristic in the bass to compensate

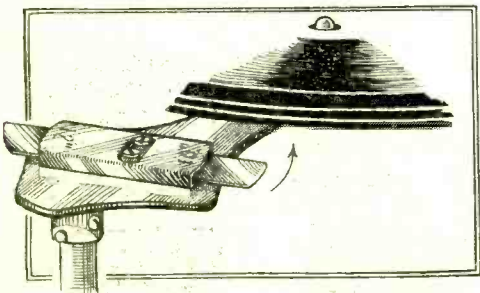

Record support and selector blade in the Garrard record-changer.

for restriction of amplitude in recording below 250 cycles. This method is much less prone to frequency doubling and modulation of high by low frequencies than the formerly popular method of obtaining a rising characteristic by amplitude distortion.

Quite one of the most interesting exhibits relating to pick-up design was the curve tracer shown by the Research Dept. of the Gramophone Company. A special falling tone record with a range from 5,000 to 40 cycles is used to energise the pick-up, and the output, after passing through a

three-stage amplifier, is connected to an Evershed and Vignoles recording voltmeter driven by a flexible cable from the turntable motor.

Self-starting Synchronous Motors.

A new development in gramophone motors is the introduction of the self-starting synchronous type. The new Harlie "Midget" (Model 61) and the B.T.-H. "Truspeed" motors are typical examples of this type. In the latter a machined and dynamically balanced two-pole motor running at high speed is used and is geared through a two-start worm to the turntable spindle. When the current is first switched on the motor functions on the induction principle, and it rapidly runs

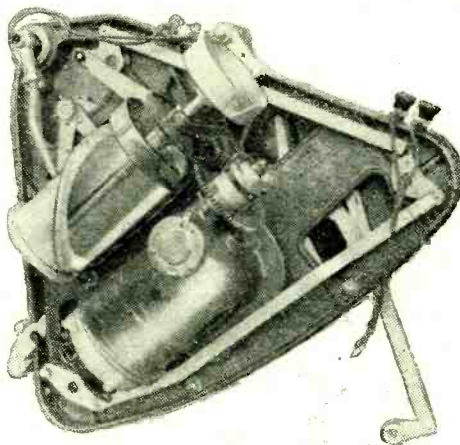

Underside of Garrard record-changer unit.

up to synchronous speed when the synchronous torque is sufficient to hold the speed constant against the induction effect, which would otherwise tend to increase the speed indefinitely. Actually the torque of this motor is between 500 and 670 gm/cm., depending on the voltage of the supply.

The demand for additional gramophone equipment for use in conjunction with the many popular three-valve self-contained

mains receivers has resulted in a variety of units which may be aptly described as playing desks. The most popular design would appear to be that followed by the designers of the "Ad-a-Gram," "Apollo," "Adapt-o-Gram," and the "Gramadaptor." The cabinets are of shallow design and form a sub-base for the receiving set. In the case of the two latter makes the

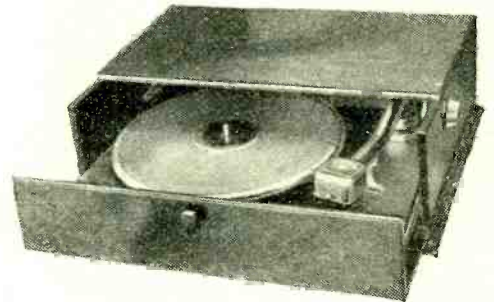

"Gramadaptor" record-playing unit.

motor board automatically slides forward for record-changing when the front lid is opened. A more ambitious form of conversion is exemplified in the Lawson and Raphael "Bureau-Gram," which, as its name implies, forms a pedestal for the self-contained receiver.

Record-changers:

This year no fewer than four different types of record-changer were shown. The H.M.V., which made its appearance last year, is now available in its original form, together with pick-up as a playing-desk unit. One or two minor improvements have been, however, incorporated in the models fitted to the more expensive H.M.V. radio-gramophones. The new Garrard record-changer is of simple and robust design, and, judging from the number of radio-gramophones already fitted with this unit, is likely to become extremely popular. The whole of the movement is controlled by a single cam drum which is driven through a clutch from the



The Gilbert record-changer turns over each record and plays both sides.

Gramophone Equipment.—

turntable motor. No power is absorbed by the changer mechanism while the record is being played, and during this period the tone arm is quite free. Selection of records is made by three rotating supports fitted with thin separator blades and actuated by link couplings underneath the motor board. The Sonochorde is another interesting design in which the records are handled by rubber rollers and the mechanism, after playing through the records on one side, turns the complete set over and plays the opposite sides. The ideal arrangement, in which a record is turned over and played on both sides before rejection is to be found in the changing mechanism fitted to the Gilbert radio-gramophone. Two separate claws are employed, one for transferring records from the magazine to the turntable, and the other for lifting the record, turning it over and replacing it on the turntable. The time interval required for both processes is 18 seconds, and the mechanism would appear to be thoroughly reliable. In our opinion all record-changers will have to be constructed on this principle

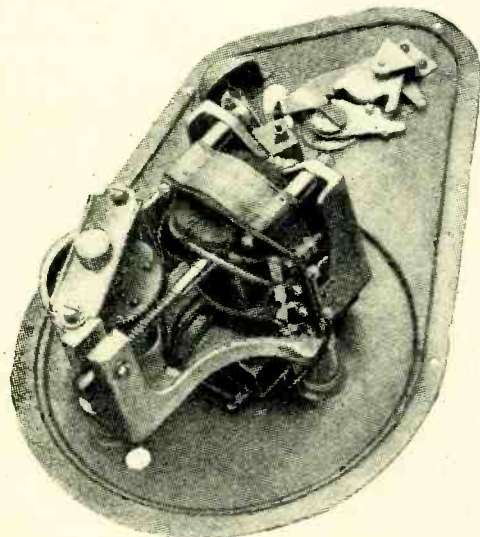

B.T.H. "Truspeed" self-starting synchronous gramophone motor.

before they become really popular, and we hope that this new design will be put into commercial production at an early date.

Home Talkies.

The "Filmovox" gramophone attachment for home cinematograph projectors, demonstrated by Messrs. Selfridge, is a new development which should do much to popularise home talkies. The turntable of the unit is friction-driven on the underside by a large-diameter rubber wheel connected through a flexible cable with the projector, and the pick-up is made to traverse the record with parallel motion through gearing. It will be seen that the needle traverses the record at constant linear speed, and that the turntable revolutions will be slower at the outside than at the inside of the record, with a consequent increase in the playing time. A library of records and films is in course of production, and the price of the outfit has been provisionally fixed at £10 10s.

ooooooooo *This Season's* oooooooooo
Valves

WE are rather apt to take for granted the exceptional performance of a modern receiver.

If we pause awhile and consider the sets of two or three years ago, and compare the results, we are constrained to ask which is the single factor that has contributed most to the vast improvement. There is not the slightest doubt that we must turn for the answer to the thermionic valve, which has been developed at a prodigious rate.

No slackening of effort has taken place this season, for a number of new valves make their appearance, and much improvement has been made to the types already existing. The large scale models of electrode construction which were shown on the leading manufacturers' stands bear witness to the efforts that have been made to ensure absolute rigidity and hence absence of microphony.

The Screen-grid Valve Superseded.

The ordinary screen-grid valve which a comparatively short time ago was hailed as a panacea for all high-frequency troubles seems to be disappearing in favour of the variable-mu type, which has played a large part in making possible the

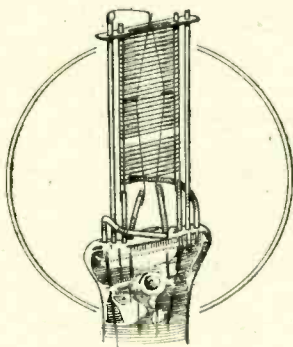

Constructional details of the Osram VS2, a battery variable-mu type.

modern superheterodyne. The use of this type of valve is not confined to A.C. mains sets, as was the case last year, for there are a number of both battery and D.C. mains models now available. For two-volt battery sets there is the Cossor 220 VSG, the Marconi and Osram VS2, the Mazda S215 VM, the Mullard PM12V, and the Lissen SG2V, all of which have a mutual conductance between 1 and 2 mA/volt and are capable of giving a full-range control of volume making use of the bias battery for the output stage.

D.C. Mains Valves At Last!

There has been definite progress with valves for D.C. mains. Those having this type of supply need no longer fear that they will have to foot a heavy bill at the end of the quarter, as the consumption of a set will not exceed about 60 watts at the most, or with the latest 0.1 amp. series, some 20 watts. In addition, the

D.C. set designer has at his command valves for the H.F. amplifier, power detector, and small output stage which are in no way inferior to their A.C. counterparts. When the indirectly heated D.C.



Mazda 2-volt battery variable-mu, the S 215VM, and (right) the Lissen 2-volt battery type the SG2V.

valves were first embarked upon it was found that the heater-cathode insulation was liable to break down under the influence of high voltages developed in a multi-valve set. Continual research has produced a D.C. valve in which the heater-cathode insulation is unaffected by a difference of potential of considerably over 100 volts. The number of Marconi, Osram, and Mazda D.C. mains valves now totals 15, so that a wide choice is available. Interesting newcomers in this class are the Marconi and Osram VDS and the Mazda DC/2SGVM, both of which

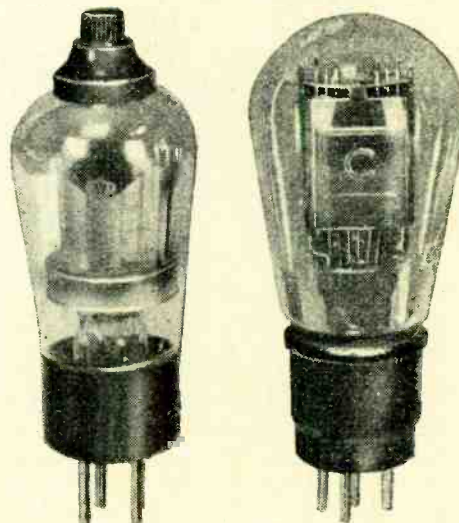

The Six-Sixty battery type screen-grid valve and the Cossor directly heated Pentode.

are variable-mu valves, the former having a heater consumption of 0.25 amp. at 16 volts and the latter 0.1 amp. at 20 volts.

This Season's Valves.—

Although the use of the screen-grid valve as a detector is not new, up to the present it has only been employed in isolated cases. There are to be found this season a number of sets with this feature embodied, notably on the G.E.C. stand. The advantages are

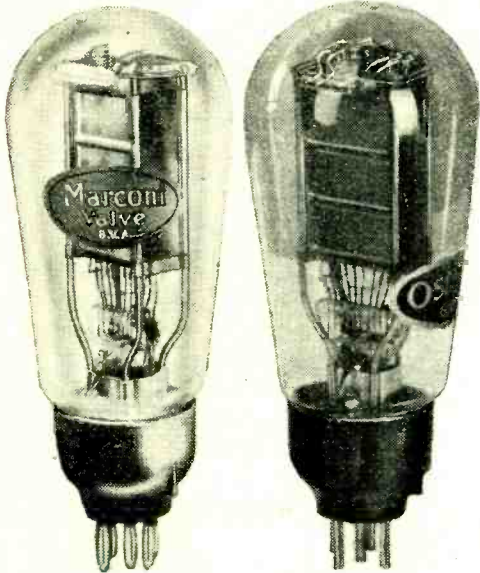

Marconi output valve the PX25 and the Osram directly heated Pentode type PT25.

considerable, for not only does the S.G. valve give a larger output than the triode for a given input, but the input capacity, which is extremely small, remains constant throughout the waveband. With the triode the input capacity is large, and changes according to the frequency being received, thus demanding a change of trimming capacity if ganged condensers are used. The value of the anode load using a paralleled transformer is somewhat critical and should not exceed 40,000 ohms in the case, for instance, of the Marconi and Osram MS4B.

Special Detectors.

Among other special detectors reference must be made to the Mullard 904V and the Standard Telephones and Cables "Micromesh" HLA1, in which attention has

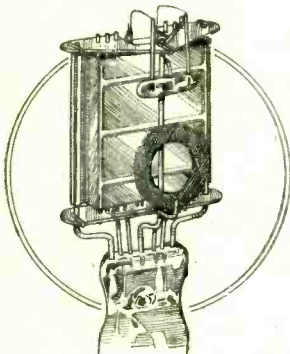

Drawing of the electrodes of the new Osram PT4 with directly heated filament (4 v. 1 amp).

been given to the anode-to-grid capacity to minimise Miller effect. There is no counterpart yet to the American Wunderlich valve, which permits many circuit innovations, including push-pull detection, but a "duo-diode," as it is called, was to be found in certain superheterodynes at the Show. This valve, which is an ordinary Mazda indirectly heated full-wave mains

rectifier, type UU2, is fed from the I.F. stage and forms part of a push-pull circuit. By virtue of wide spacing of the two anodes, the inter-electrode capacity is low.

Valves in New Receivers.

A number of receivers being exhibited were found to contain an aperiodic H.F. stage (screen-grid). Actually it would be better to call them semi-aperiodic, as they are arranged to peak at the upper end of both wavebands to compensate for the natural drop in dynamic resistance of sharply tuned circuits at these wavelengths.

The demand for high-quality reproduction at a realistic volume level has influenced the valve makers to produce a number of new and highly efficient output valves. The directly heated pentode capable of handling powerful signals bids fair to rival the power triode for the reason that it is now possible with such valves as the Marconi and Osram PT25 to extract as much as 40 per cent. of the D.C. anode dissipation as A.C. energy. With the three-electrode valve the relationship seldom exceeds 20 per cent. Other new directly heated pentodes are the Cossor PT41B and the Mullard PM24M.

To the large range of output valves has been added the Mazda PP3/250, the Marconi and Osram PX25 and a modified PX4—all triodes. A power valve which sets a new standard of efficiency is the Standard

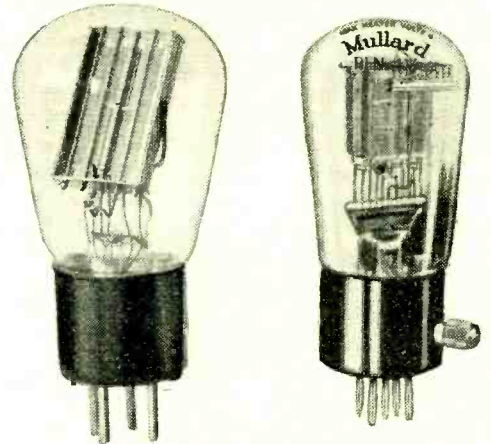

The remarkable "Micromesh" power valve PA1. On the right is the Mullard Pentode type PEN4V.

Micromesh PA1, with a mutual conductance exceeding 12 mA/volt; this is almost double that of any other valve on the market.

The Wireless World INFORMATION BUREAU.

Conditions of the Service.

(1) THE service is intended primarily for readers meeting with difficulties in the construction, adjustment, operation, or maintenance of wireless receivers described in *The Wireless World*, or those of commercial design which from time to time are reviewed in the pages of *The Wireless World*. Every endeavour will be made to deal with queries on all wireless matters, provided that they are of such a nature that they can be dealt with satisfactorily in a letter.

(2) Communications should be addressed to *The Wireless World* Information Bureau, Dorset House, Tudor Street, E.C.4, and must be accompanied by a remittance of 5s. to cover the cost of the service. The enquirer's name and address should be written in block letters at the top of all communications

(3) The fee of 5s. covers the reply to any wireless technical difficulty, but in special cases, where the enquiry may involve a considerable amount of investigation, an increased fee may be necessary. In such cases a special quotation will be made.

(4) Questions should be clearly written and concisely worded in order to avoid delay. Where enquiries relate to trouble experienced in receivers built to specifications in *The Wireless World* a complete account should be given of the trouble, and especially the symptoms.

(5) Where reference is made to published articles or descriptions of apparatus, the title of the article, the date of publication in *The Wireless World*, and the page reference number should be given, in order to facilitate reply.

(6) Full circuit diagrams, constructional details of apparatus, or values of components for home-designed receivers cannot normally be supplied, but circuit diagrams sent in with queries will be checked and criticised.

(7) Particular makes of components cannot, in general, be recommended, but advice will be given as to the suitability of an individual component for a particular purpose specified by the enquirer.

PUBLISHERS' ANNOUNCEMENTS.

S. O. PEARSON'S popular "Dictionary of Technical Terms" issued in conjunction with *The Wireless World*, appears this month in a second edition, completely revised to bring it up to date with the latest wireless practice. In the space of 272 pages, which measure only 5x3 inches, all the terms likely to be met with in modern radio are fully explained. The price is 2s. net, or by post 2s. 2d.

The introduction of cloth-bound reading covers for *The Wireless World* is a valuable innovation

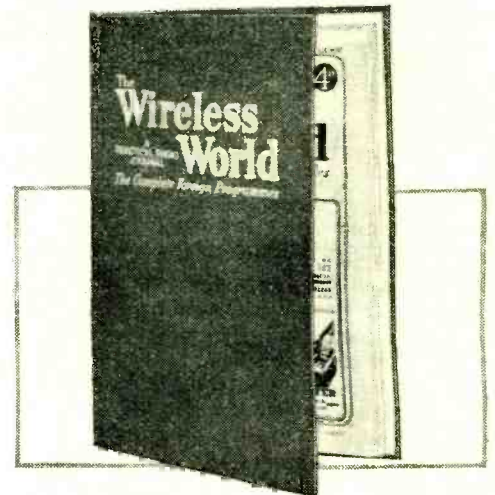

The robust container for your "Wireless World."

for readers who keep their issues in constant use throughout the week as a programme guide. Price 2s. 6d. net, or 2s. 10d. post free.

As mentioned elsewhere in this issue, blue prints for *The Wireless World* Baby Superhet. are obtainable, price 1s. 6d. post free. In addition, blue prints are available for the Autotone (February 24th and March 2nd, 1932), the Monodial A.C. Super (April 13th and 20th, 1932), and the Modern Straight Five (June 22nd and 29th, 1932), and can be obtained, price 1s. 6d., from the Publishers, Iliffe and Sons Ltd., Dorset House, Tudor Street, E.C.4.

NEWS of the WEEK

Current Events in Brief Review.

The Manchester Show.

THE Manchester Radio Exhibition organised by Provincial Exhibitions, Ltd., will be held in the City Hall, from September 28th to October 8th.

Manchester's Record.

MANCHESTER, as befits the city with the second most important wireless exhibition of the country, claims to be next to London in the number of licensed radio sets. The latest figure is 144,352. Birmingham comes next with 141,348. The city with the lowest record is Dundee, with 15,230.

Bournemouth has an outstanding place in the radio licence records, for, out of its 22,459 homes, 22,361 are licensed for listening.

Aberdeen's Wireless Show.

KITTYBREWSTER, Aberdeen, is to be the scene of a radio show opening on Monday next, September 5th, and it is hoped that multitudes of radio listeners in the North of Scotland will attend to see actual broadcasts in progress from a special studio erected by the B.B.C. During the first two weeks of the exhibition, which runs till September 24th, more than half the Scottish Regional programmes will originate at Kittybrewster.

There will be a representative trade section featuring the latest in radio receivers.

Smaller German Radio Show.

THE Berlin Radio Show, which coincided with Radiolympia, is reported to have been smaller than last year, partly owing to the absence of the gramophone and talkie film industries. The Post Office and the National Broadcasting Organisation, however, took a huge floor space, as did the Heinrich Hertz Institute, which demonstrated electrical music in a large auditorium.

Through American Ears.

AMERICA thinks European broadcasting "deplorable," that is, if Mr. Hugo Germsback, a well-known radio journalist, gives a representative opinion in an article in the *New York Sun*. Following a recent trip to Europe he writes: "In my opinion the present radio conditions abroad can best be summed up in the simple word 'deplorable.' The quality of the European programmes is mediocre. What music there is, as a rule, is good, but there are undoubtedly too many talks. There is no such thing as a continuous programme from early morning till after midnight—even by the large stations—such as American listeners are accustomed to. Even the big stations go off the air for hours at a time.

"When it comes to radio reception itself in Europe, the conditions to an American are not only deplorable but chaotic. It is practically impossible to listen to a radio programme in the larger cities such as Berlin, Paris, and London—the amount of man-made interference is simply terrific, and at present no steps seem to be taken to remedy the condition."

Post-diluvian Tests.

RADIO-AGEN, the French station which was flooded some months ago, is now testing on 455 metres with a new transmitter.

A Sporting Pirate.

AN illicit transmitter now operating on 230 metres in the region of Gouda, Holland, opens its programmes each night after Huizen closes down with a good luck message to the Post Office officials who are endeavouring to track it down.

Six-Millionth in Sight?

BY the time these words are read the five-millionth British wireless licence may have been issued. Figures issued by the G.P.O. show that up to the end of July, the number of licences had reached 4,800,000.

So now for the six-millionth.

Newcastle Follows Suit.

"THE criminal isn't given half a chance in Newcastle now," was the remark recently dropped in the dock of a Northern Police Court. The speaker was referring to the new radio tests now being conducted by the Newcastle motor cycle police, similar to those which have been put into practice in Bradford and which were described in a recent issue of *The Wireless World*.

Ever Tried It?

A PARIS amateur, tormented by the static from a neighbour's electric machinery, became the possessor the other day of one of the new gramophone records intended to help listeners to identify the various kinds of interference. This record he placed on his repeating gramophone at the open window. After seven days, according to our Paris correspondent, the source of the static dried up.

Luxembourg Again.

THE choice of wavelength for the new 200-kW Radio Luxembourg is likely to cause some animated discussion at the Madrid Conference, which opens to-morrow, Saturday. It appears that the Luxembourg officials are determined to use one of the precious wavelengths between 1,050 and 1,340 metres, despite the protests of the International Broadcasting Union.

Lady Announcer Speaks.

MADAME LUISA MARCONI, formerly Signorina Luiza Rizzi, the popular lady announcer at Milan, has given a straight-from-the-shoulder interview to our contemporary, *Le Radio*, of Lausanne, in which she denounces the listeners of the Northern European countries for their "coldness." "During my period of announcing," declared Madame Marconi, "it was from Spain and Portugal I received the largest number of sentimental letters. The Swiss, the English and the Germans are infinitely colder, though passions awakened as one goes farther south. From the Swiss, it is true. I did receive chocolate."

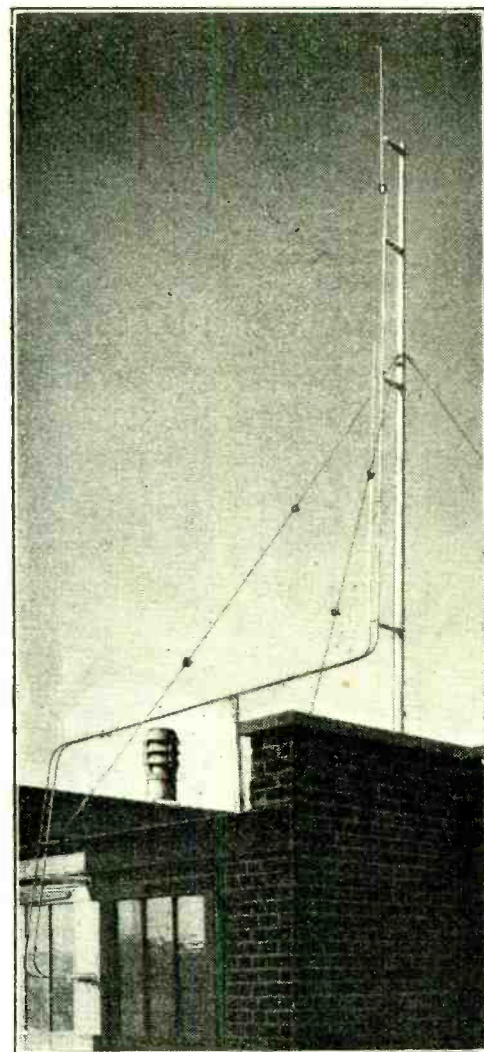

"ULTRA-SHORTS" FOR TELEVISION. The new Baird ultra-short-wave aerial, popularly designated the "Zep." type. The main feeder is a $\frac{1}{2}$ in copper tube while the second tube, exactly similar, neutralises any tendency to radiate in the original feeder.

All Eyes on Madrid.

THE British delegates at the International Radio Conference at Madrid include Government and Post Office experts and representatives of the B.B.C. Sir Charles Carpendale, Mr. Noel Ashbridge, and Mr. L. H. Hayes are already in Madrid.

The American delegation is not so large as originally planned on account of the economy cuts, which limit each member to an allowance of 6 dollars per diem instead of the original 12 dollars.

From the broadcast listener's point of view the important business of the Conference will be the discussion on broadcast wavelengths and the possible extension of the waveband either to (a) accommodate more stations or (b) to permit a wider frequency separation between each.

Another "Olympia."

THE Radio Exhibition to be opened to-morrow (Saturday) by Mr. Christopher Stone at Bon Marché, Brixton, promises to be a miniature Olympia. The products of leading manufacturers combine to make a display of interest to all listeners.

The Stenode Receiver.

THE WHITELEY AND SELFRIDGE MODEL.

An Eight-valve A.C. Radio-gramophone.

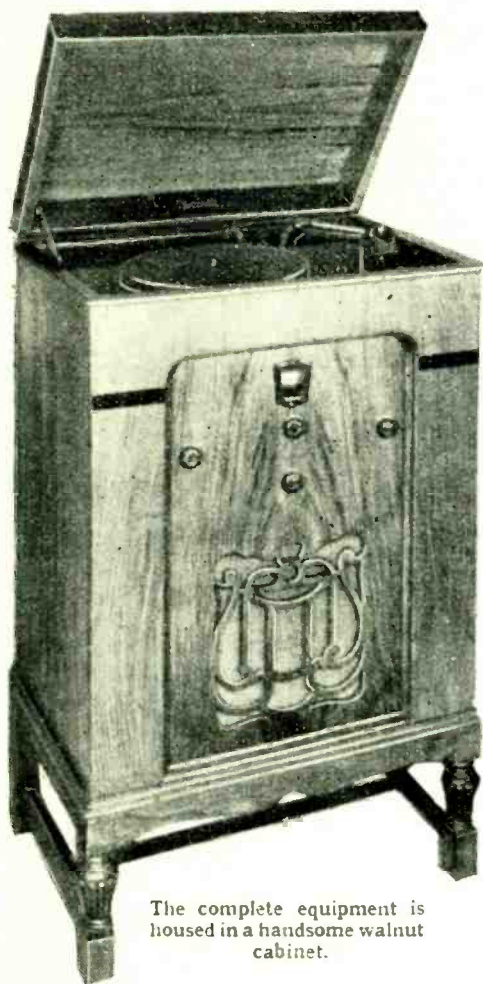

The complete equipment is housed in a handsome walnut cabinet.

QUANTITY of reproduction and freedom from interference are undoubtedly the two primary requisites of a receiver intended for the reception of broadcasting, and it is well known that their simultaneous attainment is a matter of considerable difficulty. Many proposals have been put forward from time to time as solutions, of which the two most popular are the band-pass filter and the highly selective circuit with tone correction, although a third method, involving a compromise between the two extremes, has recently made its appearance. Many receivers have appeared utilising in its entirety the band-pass principle, and a number have almost unwittingly employed band-pass filters in conjunction with the moderate degree of tone correction automatically obtainable with a pentode, but very few have appeared in which tone correction has been deliberately introduced.

It is interesting to find, therefore, a receiver in which the "Stenode" principle is fully exploited, for in the set under review no attempt is made to obtain a band-pass action in the intermediate frequency circuits. It will be seen from the circuit diagram that a variable-mu H.F. valve is preceded by a constant peak separation band-pass filter of the link-coupled type, and that the coupling between this stage and the screen grid anode bend first detector is by means of a tuned grid circuit. There are thus three signal frequency tuned circuits preceding the first detector, and it is obvious that

exceptional care has been taken to ensure accurate ganging, even to the length of inserting a fixed condenser in the interval circuit to compensate for the discrepancies introduced by the filter coupling condenser.

The aerial connection is made to the first circuit through an adjustable trimming condenser to a tapping on the medium wave coil; a method which, it is well known, leads to inaccurate ganging on the long waveband, owing to the change in the loading of the first circuit. In this case, however, additional capacities are connected across the long-wave sections of the interval and filter secondary coils to balance out this change of load and to ensure correct ganging under all conditions.

The oscillator is negatively biased by the usual cathode resistance, but is provided also with a grid leak and condenser, a value of only 25,000 ohms being assigned to the former. The grid coil is tuned, and on the medium waveband correct ganging is secured without the use of any padding condenser, although such a condenser is introduced in the usual way on the long waveband. The coupling to the first detector is by means of a pick-up coil connected in its cathode circuit.

The I.F. Amplifier.

The variable-mu I.F. stage is fed from the first detector through a transformer with tuned primary and secondary windings, and a similar transformer is employed for the coupling between the I.F. stage and the power grid second detector. It is these transformers which provide almost entirely the adjacent channel selectivity, and they are thus of considerable importance. As no attempt is made to secure a band-pass action, the coils are naturally loosely coupled, and so give a maximum of selectivity. Their resonant frequency, moreover, is considerably below that normally used in modern superheterodynes, with the result that the selectivity is higher than can be obtained from an equal number of circuits tuned to the standard intermediate frequency. The disadvantage of a low intermediate frequency, of course, is that second-channel interference problems are increased, and this explains the use of three pre-selector circuits instead of the more usual two.

The anode and screen voltage supplies of these early stages are thoroughly decoupled, and the bias voltage for both the variable-mu valves is obtained from an adjustable potentiometer which acts as the volume control, and affords simultaneous control of the amplification both preceding and following the first detector. The first L.F. stage is resistance-transformer

FEATURES.

General.—Superheterodyne with variable-mu amplification and three tuned pre-selector circuits and ganged tuning. All A.C. operation with valve rectifier, and field supply of the moving-coil loud speaker from the smoothing equipment.

Circuit.—Variable-mu H.F. and I.F. stages with highly selective tuned circuits and two stages of tone correction in the L.F. amplifier. Adjustable tone controls are fitted for both radio and gramophone. A power-grid second detector is used, and both L.F. stages are transformer coupled. The speaker is fed from the output by a choke-fed transformer, and the output valve chosen is one capable of delivering some 5,500 milliwatts.

Controls.—(1) Single tuning control with illuminated dial. (2) Combined wave-change and radio-gramophone switch. (3) Combined dual volume control and mains on-off switch. (4) Tone control operative on both radio and gramophone. (5) Tone control on gramophone only.

Suppliers.—Whiteley and Selfridge, London.

Price.—60 guineas.

coupled to the detector, the anode circuit design of which follows standard practice, and in its grid circuit is included the first tone corrector. This consists simply of a 0.001 mfd. grid condenser shunted by a 2 meg. resistance with a further 1 meg. resistance connected between the grid of the valve and earth, and it affords a compensation ratio of about 3-1 in favour of the upper frequencies.

A switch connected to the grid of this

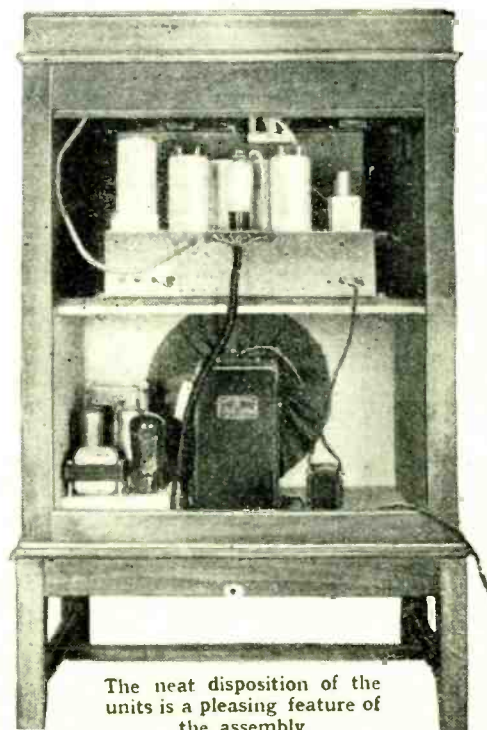

The neat disposition of the units is a pleasing feature of the assembly.

"STENODE" RECEIVER WITH TWO STAGES OF TONE CORRECTION.

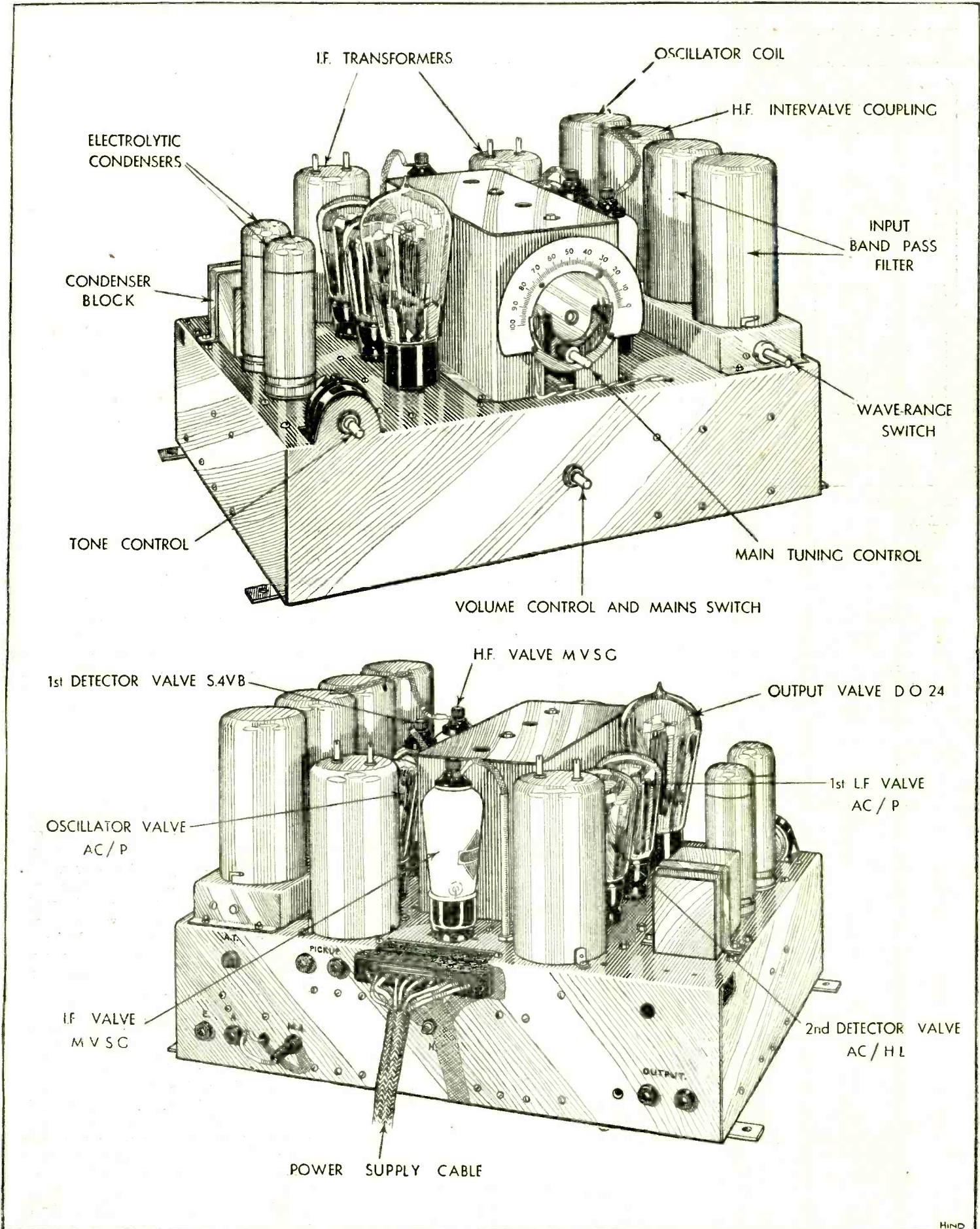

The receiver chassis in which unusually complete screening is employed.

The Stenode Receiver.—

valve allows of a change over to a gramophone pick-up, and automatically eliminates the tone corrector. The pick-up works through a 6-1 ratio transformer into its

The coupling between the first L.F. stage and the D.O. 24 output valve is again by a high-quality shunt-fed transformer. Still further tone correction, however, is introduced by the shunt-feed circuit,

The moving-coil loud speaker has its field winding energised from the smoothing circuits, and is coupled to the output valve by a choke-fed transformer of suitable ratio. Bias for the output valve is is

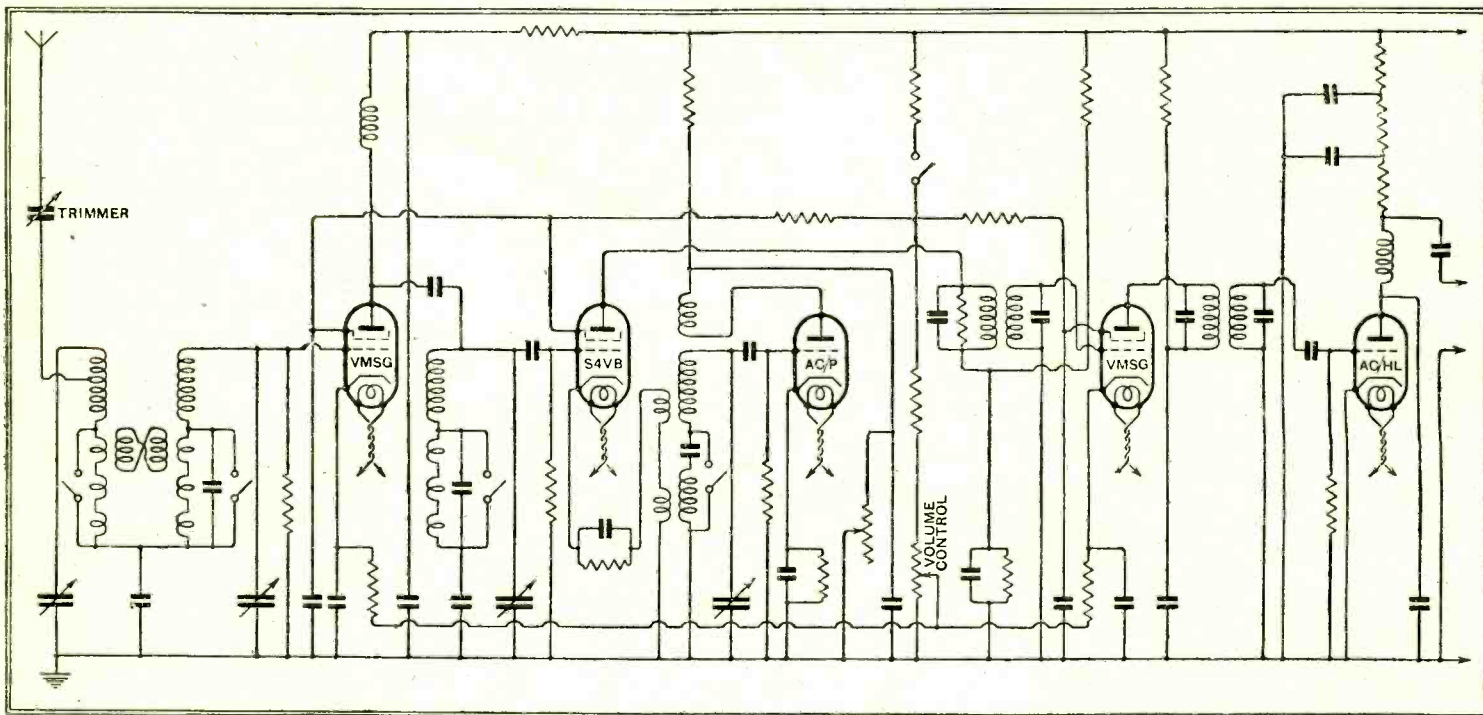

Circuit diagram of the Receiver. It will be noted that there are three pre-selector circuits which effectively prevent second-channel interference.

own potentiometer-type volume control, which is ganged to the radio control and operated by the same panel knob. A simple tone control circuit, operative on gramophone only, is connected across this transformer secondary, and it consists of a condenser in series with a variable resistance, the adjustment of which permits of the attenuation of the upper audible frequencies in order to eliminate needle scratch.

which consists of a parallel resonant circuit tuned to 4,100 cycles in series with a variable resistance which is panel-mounted as a tone control and is operative on both radio and gramophone. The operation of this tone control raises or lowers the response at the lower range of audible frequencies, while leaving the amplification of high frequencies unaffected, and enables quality of reproduction to be adjusted to individual preferences.

obtained from a resistance inserted in the common negative H.T. lead, and shunted by an electrolytic condenser. In the mains equipment a single choke affords preliminary smoothing in conjunction with two electrolytic condensers, and the smoothing for the early stages is completed by the speaker field, with which is associated still another electrolytic condenser.

The receiver is solidly built on a steel chassis, and the circuits are all thoroughly screened; the workmanship is of a high standard, and the set bears evidence of being built for lasting use. The mains equipment is assembled on a separate chassis, and is fitted, together with the loud speaker and the output transformer, into the lower compartment of the cabinet, which is lined with special sound-absorbent material. The polished walnut cabinet is of pleasing proportions, and of a style which harmonises well with most furnishing schemes.

Results.

The receiver has been thoroughly tested at a distance of nine miles from Brookmans Park, and with a moderately efficient aerial. As might be expected from a set of this type, the sensitivity proved ample for all ordinary requirements, and the weakest stations could be received at good volume, the limitation to enjoyable reception being set rather by the ratio of signal strength to background than by any lack of amplification.

The selectivity is of a very high order, and on the long waveband Königswusterhausen can be received without any trace

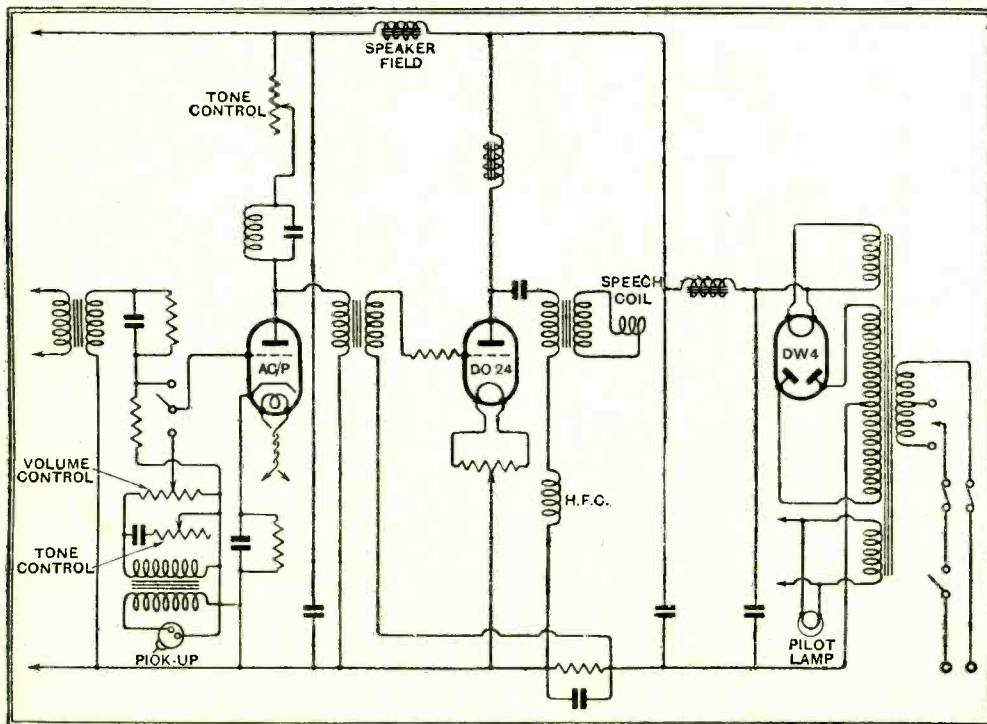

Amplifier and tone correction stages and rectifier circuit.

Curing Hum.

The Stenode Receiver.—

of modulation interference from either Daventry National or Radio Paris. On the medium waveband all the more powerful Continental stations are available sufficiently free from interference of any kind to be of entertainment value; complete freedom from carrier and sideband heterodyning under all conditions, of course, is not to be expected, but on the stronger stations it is negligible. The reception of Mühlacker at this distance from London is always fraught with difficulties, and it was not surprising to find, therefore, that although freedom from modulation interference could be secured, the programme from the former was spoiled by break-through from the London Regional. With a somewhat greater frequency separation, this interference disappeared, and no difficulty was experienced in receiving Barcelona, which has a frequency separation from the London Regional of 18 kc.

Freedom from Background.

Background noise introduced by the set itself is commendably low, and is inaudible on the stronger Continental stations; mains hum, too, is a negligible factor. The volume control is smooth and sweet in its action, and affords an ample range of control on the strongest local station. It is essential to tune accurately to resonance for good quality, and the makers would do well to consider the advisability of fitting a dial having a higher reduction ratio.

Owing to the low value of intermediate frequency employed, second-channel interference is a little more prominent than usual, in spite of the greater number of pre-selector circuits. This is not to say that it is in any way serious, however, for it occurs only on stations spaced by twice the I.F. from the local. Traces of whistles due to beat interference and I.F. harmonic interference were found at other dial settings, but not to any great extent, and the receiver may be considered as being satisfactorily free from forms of interference peculiar to superheterodynes.

The quality of reproduction is perhaps the most important point in a receiver of this nature, and it may be said that the tone-corrector stages incorporated fulfil their function of compensating for the sideband cutting of the I.F. circuits. There is no trace of boominess in the reproduction, and the high audible frequencies are reproduced at exceptional strength. There is no lack of bass, however, and the general level of reproduction is well balanced. The output of the D.O.24 valve is, of course, considerable, and ample for a small hall.

On gramophone the results are very satisfying, being indeed exceptionally good. There are two tone controls operative on gramophone, but for the best results the panel control will normally be set for maximum depth, and the exact tone desired secured by the adjustment of the control mounted on the motor board.

MODULATION hum is the name given to a type of hum which does not make its appearance until a carrier-wave is tuned in, or until the set is made to oscillate. In such a case it is of little avail to increase the smoothing in the receiver, since the fact that the hum only appears when high-frequency currents are flowing in the various circuits indicates that, from the point of view of true low-frequency ripple, the smoothing is already adequate. What is happening is that high-frequency currents are finding their way into the H.T. supply system, past the rectifier, or into the mains.

No one line of attack can be guaranteed to be efficacious in every case; there are, however, several that are well worth trying if modulation hum should arise. The simplest cure of all, where it can be applied, is to improve the earth-connection to such an extent that it simply shorts out all alternative paths to earth that the currents from the various circuits may have available.

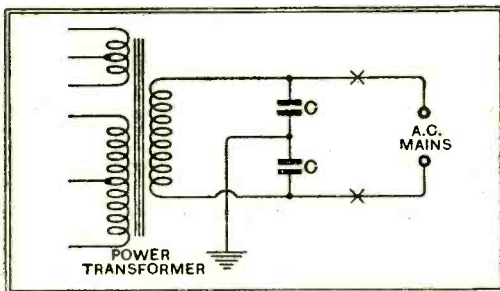

Fig. 1.—Modulation hum can often be stopped by a condenser bridge, with centre point earthed, connected across the mains. Heavy-duty H.F. chokes may be inserted at the points X to improve the filtering still further.

The next simplest scheme, and one that very often effects a cure, is shown in Fig. 1. It consists of nothing more elaborate than a pair of condensers, of capacity about 0.01 to 0.1 mfd. each, connected in series across the mains, with the junction between them connected to earth. It may, or may not, be found desirable to earth the set by its usual earth terminal as well. The effect of this simple filter may be still further increased by inserting a pair of heavy-duty high-frequency chokes in the mains leads at the points marked X.

As an alternative to this, the same two condensers may be tried, with or without their attendant H.F. chokes, as a filter across the H.T. supply system, as shown at Fig. 2. Unless one traces out the path taken by the stray high-frequency currents, which is no easy job, there is no means of telling whether the circuit of Fig. 1 or that of Fig. 2 will

be the more effective in any given case. It should be observed that with the arrangement of Fig. 2 the sole earthing-point should be the junction of the condensers; if the normal earth-terminal is also earthed, one

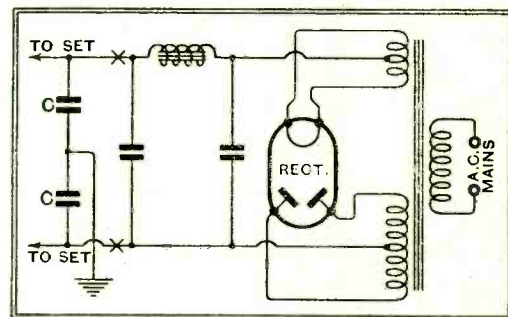

Fig. 2.—The condenser bridge of Fig. 1, with or without its chokes at X, X, inserted between eliminator and set.

of the two condensers will be short-circuited, and so rendered useless.

Another scheme that is often effective is to join two condensers in series across the two halves of the H.T. secondary winding of the mains transformer, connecting the junction between them either to earth or to H.T. positive, as shown in Fig. 3 at a and b. These condensers, whose capacities may be 0.1 to 0.01 mfd., must in case a be rated to work indefinitely at the A.C. voltage developed across each half of the secondary, or, in the case of b, must be rated to withstand a D.C. voltage equal to the sum of the peak value of the A.C. voltage (1.4 times the rated R.M.S. voltage) and the steady H.T. voltage. In a set using a 250-volt H.T. supply these condensers will each be subjected to a peak voltage of 600 to 650 volts, and *pro rata* in sets working at higher voltages.

In trying the various expedients suggested here, it should always be remembered that modulation hum may be arising from two or more sources simultaneously; it may there-

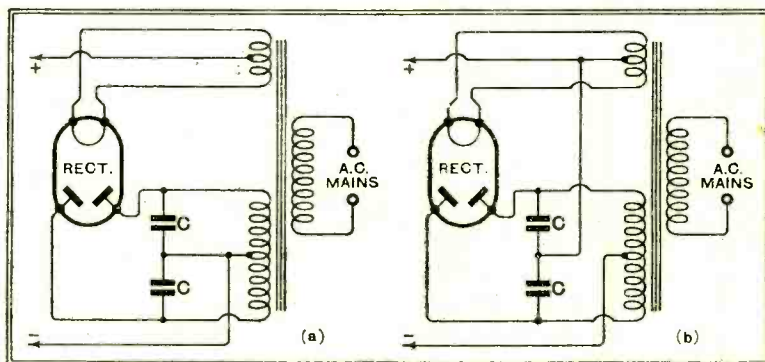

Fig. 3.—Again the condenser bridge, now connected across the complete H.T. secondary of the mains transformer. If the centre-point is taken to H.T. +, as in (b), very robust condensers are required.

fore be necessary to apply two or more remedies, one for each source, before the trouble can be got rid of completely. If, therefore, a trial of any of the schemes mentioned brings about a decrease of modulation hum, the added components should be left undisturbed while trying other possible cures already suggested. A. L. M. S.

Correspondence.

The Editor does not hold himself responsible for the opinions of his correspondents.

Correspondence should be addressed to the Editor, "The Wireless World," Dorset House, Tutors' Street, E.C.4, and must be accompanied by the writer's name and address.

High Note Cut-off at the Transmitter.

IN your issue of August 12th, Mr. Henry points out, in answer to my previous letter, that the side-bands in a broadcast transmission cannot be eliminated without spoiling the reproduction. While admitting that it was erroneous to refer to the side-bands as unnecessary for good reproduction, I would like to point out that I did not suggest they should be *eliminated* from the transmission. In fact, I expressly stated: "I am not suggesting that both side-bands should be removed in totality from the transmission; such a thing would obviously be impracticable for various reasons."

Mr. Henry is quite right in correcting my assumption that the side-bands are not indispensable. I should have said they are not indispensable in their entirety. He is also correct in saying that even the "Monodial Super" could not give us the high notes if its tuned circuits entirely cut out the corresponding side-bands. The fact remains, however, that a certain amount of side-band cutting is allowable in a tone-corrected receiver. What I had in mind, and what my suggestion actually amounted to, was that if a certain degree of side-band attenuation is admissible, would it not be advantageous, from the point of view of avoiding interference, if this attenuation of side-bands were introduced before the signal is radiated instead of in the receiver? In other words, that the transmitter should operate with a falling characteristic. I do not say that this is either a practical or a convenient solution to the interference problem. It may be quite valueless, and, in any case, as I said in my previous letter, the practical difficulties of such a scheme would be enormous. And, of course, from many points of view, any deviation from a straight frequency characteristic in the transmitter is objectionable.

But if the number of broadcasting stations continues to increase at the present rate, a time will come when something drastic will have to be done about it. In the absence of any simple and effective way out of the difficulty, it may be necessary to consider some other solution, even if it means a complete revolution in present-day broadcasting technique.

C. O. B. MAUGHAM.

Geneva.

Quality and Frequency Range.

MR. MOORBY'S letter in your issue of July 29th is very interesting, but he will, I feel sure, forgive me for pointing out an inaccuracy in his reference to the Wurlitzer organ when he states that the highest fundamental frequency given by the pipes of this organ is in the region of 20,000 cycles. Actually, the highest fundamental is 8,354 cycles, no pipe having a longer speaking body than $\frac{3}{8}$ in. Further, it is not possible to make an organ pipe with a smaller body than $\frac{3}{8}$ in. in length, this giving a fundamental frequency of 16,384 cycles. The smallest pipe in the Royal Albert Hall organ gives a note of 8,354 cycles. A reproducer with a cut off at this point would be quite capable of doing ample justice to the vast majority of organs as far as frequency response is concerned. In the reproduction of organ tone no difficulty whatever is presented by the frequency problem, unless

it be that loud speakers cannot properly reproduce the lowest seven fundamental notes of the 32ft. pedal stop—an omission of very little consequence, since the ear is equally insensitive to them and only detects the overtones. The upper register of the organ, represented by the very small pipes, is usually deficient in loud speakers which suffer from a decrement in this part of the musical spectrum.

On all other points I consider Mr. Moorby's letter a valuable one, especially his reference to what I call the *proportionality* of a reproducing system. In fact, proportionality and clarity are the two cardinal virtues in any amplifier, without which no real pleasure can be derived by the listener. When the three registers, lower, middle, and upper, are in correct proportion, none of them (to borrow a phrase from Addison) "appears to an advantage." The listener's attention should not be unduly directed to bass, middle or treble, but to all three. Personally, I assign a greater value to bass and treble, because these two *in combination* are essential to clarity, which is completely destroyed by the presence of a "middle hump." None the less, the middle is necessary if the correct proportions are to be preserved. In my opinion, normal transformer coupling gives too much middle, and resistance coupling too little; and as for loud speakers, I have yet to hear one that reproduces the proportionality of the orchestra. The distorting mirrors in the Haymarket Fun Fair make one literally scream with laughter! Yet many an acoustic reproducer distorts the original in precisely the same way. The eye is more highly educated than the ear.

I fear that I am unable to agree with Mr. Tomes's adverse criticism of Mr. Hartley's contributions to *The Wireless World*. The best of us make mistakes sometimes, and Mr. Hartley acknowledged most gracefully the few criticisms I had to offer. With the *main object* of his article I am in entire sympathy.

NOEL BONAVIA-HUNT.

Hampstead, N.W.6.

"First Principles of Television."

I AM indebted to "W. H. M." for his very fair and complimentary review of my book "First Principles of Television," published in your issue of July 8th. He does, however, raise a point which I would like to clear up, if I may have the courtesy of a little space in your correspondence columns.

"W. H. M." states that: "In describing colour television, he [the author] is evidently in error in giving red, blue and green as the primary colours and stating that yellow is a mixture of green and red, but this is a minor point which does not affect the general interest of the description."

It is because this is *not* a minor point that I welcome this opportunity to clear the matter up. It is a point which always confuses students of the elementary principles of light because, long before we begin to think of light at all, most of us learned at school that the three primary colours are red, blue and yellow, and that green is a mixture of blue and yellow. This definition, however, refers *only to pigments*, and was brought to our attention at an early age when we were solving the mysteries of a water-colour paintbox.

When we come to study light we find a

different set of principles, one of which is that the three primary colours of *light* are red, blue and *green*, and that if rays of red and green light are mixed the result is a shade of yellow which depends upon the shades of the two primaries.

In my concentration on the subject in hand, I find that I did not make the distinction clear, and I am indebted to "W. H. M." for drawing the fact to my attention. One object of my book is to show the student of television, and especially the student who is already a wireless enthusiast, that a knowledge of other sciences such as physics, optics, chemistry, and light are necessary to the television worker. Obviously, I could not include full courses in these sciences in the work; I could do no more than I have done, which is to include an outline of a few of the elementary principles which govern them, to enable the student to follow my main theme. He who would go farther must necessarily seek elsewhere for the specialised information he requires on co-related sciences.

A. DINSDALE.

New York.

THE BOOKSHELF.

Hearing in Man and Animals. By R. T. Beatty, M.A., B.E., D.Sc. pp. xi+227. (G. Bell and Sons, Ltd., London. Price 12s.)

In this book the author deals with the hearing organs in man, mammals, reptiles, birds, and fishes. These organs are examined from a physiological viewpoint, and their development from prehistoric times is described. The resonance theory of hearing in man, in which the ear is likened to a mechanical structure with a large number of taut cords of different frequencies, is treated in some detail, whilst alternative theories are also set forth. The variation in sensitivity of the human ear throughout the audible frequency range is a very important factor associated with the reproduction of sound. This, together with other points, e.g., beats, masking of one tone by another, the formation of subjective tones, etc., is treated at length, and the results applied to practice. Following on this we have the binaural location of sounds, the influence of aural fatigue, and the variation in pitch with loudness. The application of acoustic apparatus to the analysis of heart beats and sounds of other classes also finds a place.

An incursion is made into the history of various musical scales. These are discussed from the viewpoint of equal temperament, the formation of consonances and dissonances. The important subject of noise in its various forms is approached from an acoustical and a physiological aspect. Finally, the testing of aural defects and their possible remedies is detailed. There is an exhaustive list of references at the end of each chapter, which indicates that the author has left no stone unturned to obtain all the known facts. The book is one of the most interesting and readable which it has been our good fortune to review. The subject matter is presented in such a way that it can be understood and appreciated by the scientist or the layman, and should be read by both.

N. W. M.

Books on All Technical Subjects and Applied Science.—A catalogue of new and second-hand books on over 450 subjects, including 89 on wireless telegraphy and telephony, many of the books listed being rare or out of print. Revised to July, 1932, and issued by W. and C. Foyle, Ltd., 119-125, Charing Cross Road, London, W.C.2.

S.G. Valve as an Amplifier.

IN our recent review of the Savage Portable A.C. Amplifier mention was made of the use of a screen-grid valve as an amplifier, consequent upon which our attention has been drawn to the fact that the Birmingham Sound Reproducers, Claremont Works, Old Hill, Staffs, also market a power amplifier embodying a valve of this type.

The resistance-capacity coupling arrangement especially developed by D. McDonald, B.Sc., and described in *The Wireless World* dated November 12th, 1930, is employed.

BROADCAST

By Our Special Correspondent.

BREVITIES

Ottawa and Empire Broadcasting.

THE Ottawa Conference has affected broadcasting to the extent that pious wishes were expressed for a closer liaison between the broadcasting controlling bodies throughout the Empire. This must not be taken as indicating an early establishment of an all-Empire broadcasting organisation, although, as I have previously hinted in these columns, the notion of a British Empire Broadcasting Corporation is already being discussed.

Feeling in the Dominions.

It is hoped, however, that the Dominions and Colonies will show still greater willingness to use the recorded programmes which the B.B.C. are now preparing for Empire consumption, and I believe that the B.B.C. cherishes the hope that our overseas cousins will soon reciprocate with direct transmissions if not with recorded programmes of their own. And the B.B.C. is, of course, anxious to create enthusiasm for the forthcoming Empire transmissions from Daventry.

A Royal Memento.

A NEW mural panel, bearing the Royal Arms, is being carved between the right-hand double doors at the main entrance to Broadcasting House. It bears the inscription: "Their Majesties the King and Queen honoured this building with their presence, July 7th, 1932."

Why Not at the Wharf?

ALTHOUGH I am glad to hear that the Sunday evening orchestral concerts which have been so popular through two winters are to be resumed on or about October 20th, it is a little disappointing to be told that they may no longer be given in the Wharf Studio.

More Ventilation.

I am assured that this is no indication that the Wharf Studio is to be dismantled. A new ventilation system is being installed and there is the probability that "No. 10" will remain in the service of the B.B.C. for many moons to come.

But the Musical Department are anxious to use the Concert Hall on Sunday evenings, so that's that. If the results are as good as those from the Wharf, no one will grumble.

Helping Music Students.

By the way, the B.B.C. would have a fine opportunity of helping the youth of the land if they flung open the Concert Hall on those Sunday evenings for the special benefit of music students.

What about it, Sir John?

The Blessed Unnamed.

"TO an Unnamed Listener" is the title of the forthcoming series of talks and it is probably a good thing that the listener will be unnamed, considering that Mr. George Bernard Shaw will be talking "To a politician," that Mr. J. B. Priestley will be lecturing "A Highbrow" and that other participants in the series will be those straight-speaking people, Evelyn Waugh, Stella Benson and Walter Elliot.

Apathy in Scotland.

MENTION of experiments at Falkirk still seems to produce a hopeless expression on the faces of the B.B.C. engineers. "Apathy; disgusting apathy!" was what one of these gentlemen exclaimed when I asked him last week what kind of response was being shown in Scotland to the opening of tests by the National transmitter.

No Complaints.

It seems that only 200 requests have been received from all over Scotland for the pamphlet regarding reception from Falkirk; only 20 listeners have gone to the extent of writing letters on the subject.

Still, at the time of writing, there have been no complaints apropos the Scottish National tests which began last week, and that is something for which the engineers can be thankful.

Listening in School.

WHEN school broadcasting has come up for discussion my sympathies have been with the unhappy scholars. The old Victorian maxim to the effect that "children must be seen and not heard" has been twisted round with a vengeance, so that tiny mites must now hear and not see. In too many cases children have had to stand the double strain of trying to hear what is being said and then to understand it.

All honour, then, to the Central Council for School Broadcasting for issuing a list of commercial receivers approved as suitable for use in schools.

The Acid Test.

Every manufacturer whose name appears in the list has had to demonstrate his apparatus to the Approval Sub-Committee, on premises (selected by the Council) where the acoustic conditions approximate to the average classroom. Most of the leading makers are represented with sets of the all-mains type and moving-coil loud speakers.

There is one sentence in the explanatory pamphlet which deserves to be printed in letters of gold. "The Council has formed the opinion that expenditure of time and money on school broadcasting can be justified only where the voice as reproduced approximates to that of a speaker in a classroom."

Melba and Caruso Broadcast.

A SPECIAL treat is in store for gramophone listeners on September 18th, when a recital of records made by Melba and Caruso will be given in the National Programme.

Cool Claims.

WHAT was the coolest place in London during the heat wave? Mr. Garry Allighan, the R.M.A.'s official publicist, claimed the honour for Radiolympia, but quick on his heels came the B.B.C. with the declaration that the temperature was lowest in the studio tower of Broadcasting House. "While the rest of the world," runs the B.B.C. statement, "was sweltering in temperatures verging on the 90's, the studios in the towers registered 68 deg." Yet Mr. Moody, organiser of Radiolympia, would tell you that "Kensington Cathedral" was down to 65 deg." Frankly, I find it difficult to believe this. To one who trudged, footsore but happy, from one end of Olympia to the other on the hottest day, the temperature seemed to be topping ninety.

Safety First.

FOR the truth of Olympia's best story I have abundant witness. A commissionaire was heard conferring at midnight with a colleague a few paces from *The Wireless World* stand. "Say, Charlie," he asked, "Why do you keep the light on beside that blinking Robot?" "Why?" retorted the other, "because I wouldn't trust it in the dark. I've been reading a story about a bloke who made a monster of that sort and one night it got out of hand and throttled him. Believe me, Bill, I would rather watch that Robot at a distance."

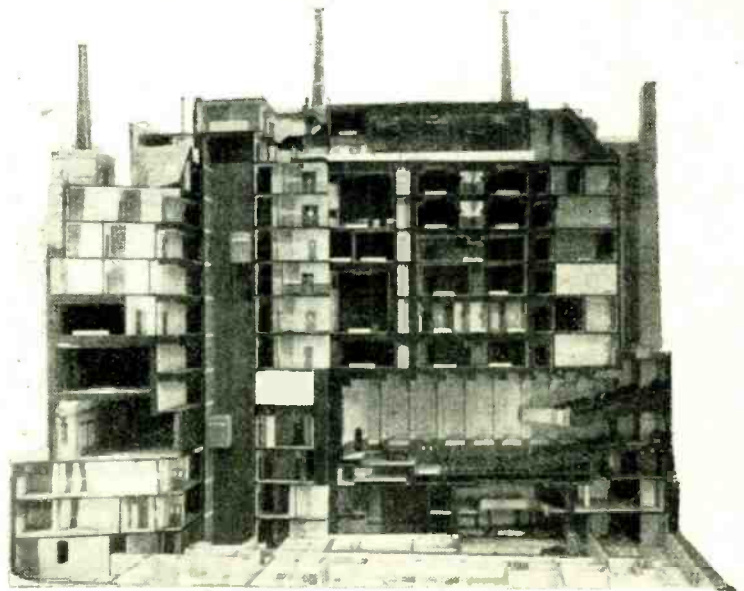

"B.H." DISSECTED. A rear view of the model of Broadcasting House which was displayed on the B.B.C. stand at Olympia. This is an imaginary glimpse, from the east side, the front entrance being on the left. The main features, including the insulated central tower, the entrance hall and the large concert studio, stand out clearly.

READERS' PROBLEMS.

THESE columns are reserved for the publication of matter of general interest arising out of problems submitted by our readers. Readers requiring an individual reply to their technical questions by post are referred to "The Wireless World" Information Bureau, of which particulars, with the fee charged, are to be found on page 244.

Conditions for Measurement.

WHEN making measurement of the voltages or currents existing in a mains-operated receiver, it should be emphasised that all valves should be working normally, and particularly that the load imposed on the source of H.T. supply should also be normal.

If, for instance, a power grid detector be removed from its socket while making tests of other valves, an appreciable rise in eliminator voltage will take place through reduction in load, and so the meter readings will be misleading. Still worse discrepancies are likely to occur as a result of interrupting the anode circuit of the output valve—or even of one output valve in cases where push-pull or parallel-connected valves are used.

Failure to observe these precautions is probably responsible for the fact that querists sometimes submit to us a list of the currents taken by the various valves in their sets which is almost "impossible"—at any rate, from which no logical conclusions can be drawn.

Auto-transformers and Plain Transformers.

IT was recently shown in the pages of this journal that difficulties may arise in connection with grid-circuit decoupling when a

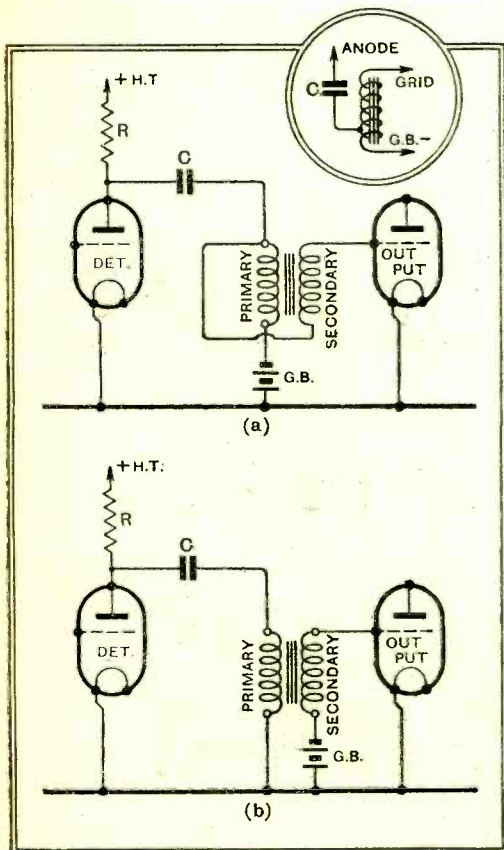

Fig. 1.—Diagram (a) shows a resistance-fed auto-transformer; the equivalent electrical circuit is given as an inset. For purposes of comparison, a plain resistance-fed transformer is also shown. R, feed resistance; C, coupling condenser.

parallel-feed transformer, connected as an auto-transformer, is used as an L.F. coupling. This arrangement is shown in Fig. 1 (a), of which the inset shows the equivalent electrical circuit.

In reply to a reader who raises the point, it should be made clear that these strictures do not apply to a transformer connected in the normal way, but fed through a resistance-condenser combination, as shown in Fig. 1 (b).

From Batteries to Mains.

IT is easy enough to change over the anode current supply of an existing receiver from an H.T. battery to mains feed; at the worst, it is unlikely that anything more than a little extra decoupling for one or two of the circuits, and possibly the addition of an output filter device or transformer, will be necessary. But it is a different matter when it comes to the question of converting a battery set for all-mains operation: by this is generally understood the substitution of indirectly heated valves of the appropriate type.

The difficulty here is to cope with the increased efficiency of these valves as compared with their battery-fed counterparts. A.C. and D.C. valves are generally at least twice as "good" as those which they would be called upon to replace, and, as a result, H.F. and L.F. instability is quite likely to be the disappointing result of making a change, unless due care is taken.

We would impress on correspondents who have written to us on the subject that this question of conversion can hardly be treated from a general aspect, and that each case has to be taken on its merits. Broadly speaking, the rules are that extra screening and general isolation of individual H.F. circuits may be necessary, and that extra decoupling on the L.F. side will almost certainly be required. Further, to cope with the almost embarrassingly high L.F. magnification that is obtainable from mains valves, it may be necessary either to abandon one L.F. stage, or at any rate to employ some form of intervalve coupling in one of the stages that will provide less magnification than the original arrangement.

Multi-wire Aerials.

FOR reception purposes, there is little to be gained by installing an aerial with a number of parallel wires; unless a spacing of half-a-dozen feet or more can be allowed between wires, a single conductor will give just as good results.

This is in reply to a reader whose set has hardly any margin of sensitivity, even for reception of the local stations; he naturally wishes to obtain somewhat louder signals, and suggests the method of altering his aerial which we have mentioned in the preceding paragraph.

Rather than the addition of parallel wires, we recommend that an attempt should be made to increase the height of the aerial, and at the same time to increase the spacing between it and earthed objects. Generally, these two recommendations imply pretty much the same

thing, but occasionally it is possible to find a position for the aerial that will result in an increase of its effective height without any great alteration to its height above ground.

Dual-purpose Aerial Coil.

WE are asked to explain, as simply as possible, how the aerial coil of the Pye "K" receiver acts as a reaction winding as well as fulfilling its normal function. Our querist has studied the review of this receiver which appeared in our issue of July 22nd.

What actually happens should be made clear by a consideration of Fig. 2, in which the reaction circuit is shown in heavy lines. A proportion of the amplified high-frequency voltages appearing on the anode of the detector valve are passed back through that part

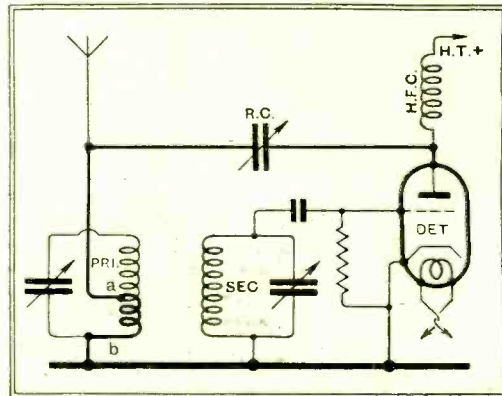

Fig. 2.—One coil: two purposes. Simplified diagram showing the use of a section of the aerial coil as a reaction winding.

of the primary coil included between the points marked a and b; the actual extent of feedback is determined by the setting of the reaction condenser RC. The "sense" of the primary winding is such that voltages induced into the secondary will be in the correct phase for reaction effects.

Thanks to the interposition of the H.F. choke, there is virtually no loss of incoming signal energy. In practice, this simplification of design, by the avoidance of a reaction winding, is entirely satisfactory, but a certain amount of care, both with regard to circuit constants and layout, is necessary for the attainment of best results. The general scheme has other applications, but obviously has special attractions in a set with a magnetically coupled input filter.

FOREIGN BROADCAST GUIDE

KAUNAS

(Lithuania).

Geographical position: 54° 55' N.; 23° 56' E.

Approximate air line from London: 1,015 miles.

Wavelength: 1,935 m. Frequency: 155 kcs.

Power: 7 kw.

Time: Central European (coincides with B.S.T.).

Standard Daily Transmissions.

10, 15, B.S.T., sacred service relayed from Kaunas Cathedral (Sun.); 12.00, weather and news; 18.30, concert, talks; 20.00, Time Signal, weather, news; 21.10, concert. The studio usually closes down at 23.00.

Announcer: Man.

Opening Signal: A few chords on piano, followed by ticking of a clock and time signal (chimes).

Interval Signal: Gong.

Call: *Allo! Allo! Lietuvos Radio Kaunas*

Closes down with the words: *Radio Kaunas sako la banaki* (Radio Kaunas says good-night) followed by the Lithuanian National Anthem (Gramophone record).

The Wireless World

A
PRACTICAL RADIO
JOURNAL
22nd Year of Publication

No. 680.

FRIDAY, SEPTEMBER 9TH, 1932.

VOL. XXXI. No. 10.

Editor:

HUGH S. POCOCK

Proprietors: ILIFFE & SONS LTD.

Editorial Offices:

116-117, FLEET STREET, LONDON, E.C.4.

Editorial Telephone: 9472 (5 lines).

Advertising and Publishing Offices:

DORSET HOUSE, TUDOR STREET,
LONDON, E.C.4.

Telephone: City 2816 (15 lines).

Telegrams: "Ethaworld, Fleet, London."

COVENTRY: Hertford Street.

Telegrams:

"Cyclist, Coventry."

Telephone:

5219 Coventry.

BIRMINGHAM: Guildhall Buildings, Navigation Street

Telegrams:

"Autopress, Birmingham."

Telephone:

2970 Midland (3 lines).

MANCHESTER: 260, Deansgate.

Telegrams:

"Iliffe, Manchester."

Telephone:

Blackfriars 4412 (4 lines).

GLASGOW: 26B, Renfield Street, C.2.

Telegrams:

"Iliffe, Glasgow." Telephone: Central 4857.

PUBLISHED WEEKLY. ENTERED AS SECOND
CLASS MATTER AT NEW YORK, N.Y.

Subscription Rates:

Home, £1 1s. 8d.; Canada, £1 1s. 8d.; other
countries abroad, £1 3s. 10d. per annum.

As many of the circuits and apparatus described in these
pages are covered by patents, readers are advised, before
making use of them, to satisfy themselves that they would not
be infringing patents.

CONTENTS.

	Page
Editorial Comment	253
Matching Coils	254
High Inductance Smoothing Choke	258
Distant Reception Notes	259
Unbiased	260
News of the Week	261
Nuts to Crack	262
BROADCASTING STATIONS	
ABROAD, pp. 1-11	
PROGRAMMES FROM	
ABROAD, pp. 111-XXIII	
The Studio Code	263
"Ekco" Model M.23 Reviewed	264
Practical Hints and Tips	266
Police Wireless	268
Broadcast Brevities	269
Readers' Problems	270

EDITORIAL COMMENT.

After the Show.

THE Radio Show at Olympia, the biggest Exhibition of its kind ever held here, has come and gone, and, judging by official reports issued by the organisers, the Show has been a gratifying success.

The Exhibition is intended to interest not only the public direct, but also all those whose business it will be to sell wireless apparatus during the coming season.

It has been stated officially that no less than fifty million pounds' worth of radio instruments and components will pass into possession of the public as a result of the Exhibition, as compared with twenty-nine million pounds' worth of business last year.

This statement is extremely encouraging, coming at a time when this country has by no means recovered from depression, but we think a little further explanation should have been given as to what these figures really represent. They are not the total of orders placed by the public who will use the apparatus, but represent the dealers' estimates of what they can sell.

Again, the figure for the sale of valves is put at ten million and the orders for sets at two million. We would like to know whether we are not correct in supposing that ten million valves represents the estimated sale of valves by the various manufacturers, including valves in the two million sets. If we take the average number of valves in a set at three, we have already accounted for six million out of the total of ten million, so that in the official estimate it would appear that this sale of six million valves has probably been included twice over, and so it may be with components and batteries brought into the total of fifty million pounds. However, fifty million is a good round figure, and probably serves

as well as any other the purpose for which it was given, namely, to impress upon the public the success of the Exhibition and the importance of the industry.

The Demonstrations.

BEFORE we leave the Wireless Show as an event of the past, we feel that it is necessary to say a word about the demonstrations. The demonstrations carried out by the firms who had special audition rooms for the purpose were, for the most part, extraordinarily well done, and the firms concerned are to be congratulated on their enterprise.

We cannot help feeling, however, that arrangements for demonstrations are still totally inadequate for a wireless show of such dimensions. The number of persons who could attend the overcrowded demonstration rooms was but a very small percentage of the total number who visited Olympia, and yet the purpose of the Show is to sell wireless and gramophone reproducing equipment, the sale of which should depend not upon appearance but upon performance. It may be argued that the arrangements provided by the B.B.C. for an amplifier to feed sets or loud speakers on every stand covered these requirements, but it seemed to us that the futility of this form of demonstration was never more clearly shown than at this year's Exhibition. Not only is this form of reproduction no proper indication of the performance of a receiver, but the programme material available for reproduction during a large part of the period of the Show was quite unsuitable. Those responsible for the Exhibition should put their heads together and see whether it is not possible to devise some more satisfactory arrangement before the next Show comes round.

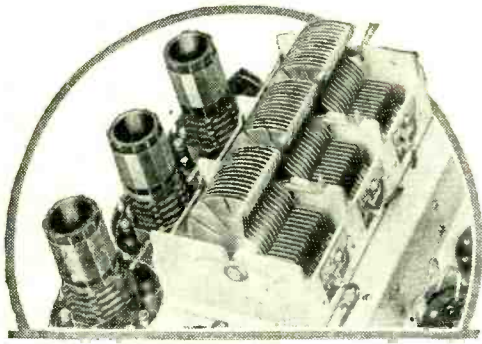

Matching Coils

By A. L. M. SOWERBY, M.Sc.

Part I.—How to Ensure Perfect Ganging.

IN constructing a receiver in which it is intended that all the tuned circuits should be operated simultaneously by a single knob, there are two essentials that must be attended to if the circuits are to tune accurately together over the whole waveband. It is first necessary that the various sections of the tuning condenser should be perfectly matched, so that the tuning capacity in use shall be the same for all circuits, no matter what the setting of the dial. As a second essential, the coils used must all be of exactly the same inductance, so that they may all be tuned to the same wavelength by the matched capacities.

For the matching of the sections of the multi-gang condenser it will in nearly every case be necessary to rely upon the maker of that component. In other words, a factory-built and factory-matched unit must be purchased, since the facilities at the command of the ordinary amateur are not sufficient to enable him to adjust a number of separate condensers to have identical capacities at all points of the tuning range.

In the matter of coils the limitations are less severe, in that they are not subject to variation during the process of tuning, and so have to be matched only once. The constructor of a set, especially if it is to be a set built to his own design, would often like to make his own coils, if only because the exact coils he wants are probably not available from any of the manufacturers. Alternatively, the builder of a set to a published design may already be in possession of a number of coils which might be used in the receiver to be built if only they were known to be matched.

Systematic Checking.

Even if the design is not exactly that required for the new set—if, for example, they are tapped in the wrong places or have no reaction winding—they at least represent screening boxes fitted with formers which, but for the bugbear of matching, could quite readily be rewound for the new set.

It is an unfortunate fact that a certain amount of laboratory apparatus, together with a good deal of experience in regard to likely sources of error, will be needed

if an attempt is to be made to match the various coils as components before they are built into the set. But, on the other hand, little more than careful and

THERE are probably many constructors who would like to wind the tuning coils for their single-control receivers, but who feel that the purchase of apparatus for exact matching of inductance is not worth while. This article, contributed by Mr. Sowerby, who has carried out considerable research in coil design, explains that the set itself can provide practically all the apparatus necessary for accurate balancing of tuned circuits.

systematic checking is needed if the matching of the coils is done after the set is built, for the set itself can be made to provide practically all the apparatus necessary.

The method of checking to be described is one that really depends on the correctness of matching of the sections of the ganged condenser, but the necessary adjustments to the coils will automatically be done in such a way as to compensate, so far as coil adjustment can do so, for any discrepancies that the condensers may exhibit. It will therefore be worth while to apply the checking pro-

cess to any set which gives rise to a suspicion that the tuned circuits are not properly matched, no matter whether the fault should properly be attributed to the condenser or to the coils.

The principle of the checking process suggested is not at all difficult to follow, but it is necessary, before describing it, to make absolutely clear the point from which the checking starts. It is assumed that the set has already been built up and completely wired, every component, including the coils, being in its proper position and correctly connected up. If the coils have been wound at home, it is assumed that they have been roughly matched by winding them on formers of the same size, using the same number of turns of the same gauge of wire in every case. For example, the medium-wave windings might consist of 100 turns of 30 d.s.c. wire on a 1½ in. former, and the long-wave coils of 250 turns of 36 enamel wire wound in slots.

Coils of Different Diameter.

If there happens to be in stock an odd lot of formers of different sizes there is not the slightest objection to using them, but it will then be necessary to do a little preliminary rough matching after winding them and before building them into the set. This can be done with quite sufficient accuracy by connecting up one coil as the aerial coil of a single-valve set, and noticing the setting of the tuning condenser required to bring in the local station. The turns on the other coils are then so adjusted that the local station is tuned in at the same setting of the dial, an error of two or three degrees being permitted at this stage.

Since it is difficult to couple a screened coil to an aerial without some auxiliary means, it is suggested that a coil of about five turns of wire be wound on any convenient former (e.g., a matchbox) and connected as shown in Fig. 1. If this coil is omitted and the aerial is connected directly to the grid of the valve tuning will probably be so broad that it will be impossible to determine the point of resonance even approximately, since no reaction is being used. The same coupling coil and the same aerial must, of course, be used for all the coils.

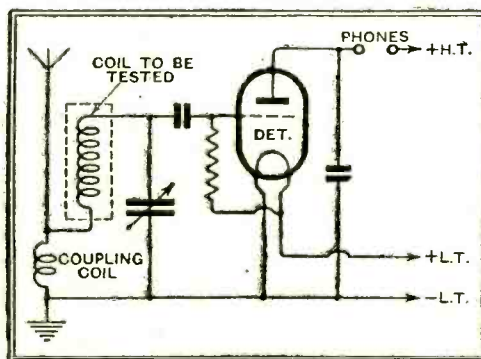

Fig. 1.—Matching coils roughly with the aid of signals from the local station. This is only necessary when coils of different physical dimensions have to be matched.

Matching Coils.—

At first glance it would seem that, by really careful matching on these lines, it would be possible to bring all the coils to an identical value of inductance, but in practice, owing to differences in the stray capacities of the various coils, such matching is not really reliable, however carefully it is done. The small differences that remain can be detected with certainty only in the receiver itself, where the trimmers of the multi-gang condenser can be used to even up the stray capacities.

The next step, therefore, is to build up the receiver, finishing it off completely so far as the wiring is concerned, but arranging matters as far as possible in such

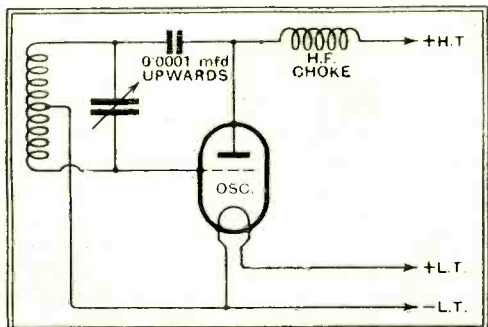

Fig. 2.—A simple and very convenient oscillator with the aid of which signals on any wavelength may be obtained for ganging purposes whenever required.

a way that the coils are reasonably easy to get at for any final adjustments that may be found necessary.

For carrying out the ganging two auxiliary pieces of apparatus are necessary. Of these the first is a local oscillator capable of being tuned over both the wave-ranges. This is used to provide a signal of any desired strength on any wavelength, for while it is possible to carry out a complete check of the tuning of a ganged set without any signals other than those provided by the various broadcasting stations, the work is enormously facilitated by having a controllable source of signals at hand. The time spent in making up the oscillator will probably be repaid at least twice over in the saving of time brought about by the greater convenience of working with it at hand.

A Simple Oscillator.

There are many possible circuits for an oscillator, but that shown in Fig. 2 is probably the most simple. It uses few components, and those very ordinary ones, while it requires neither skill nor knowledge to persuade it to function, being practically infallible in this respect. It will work equally well with any type of valve, and requires only a very low anode voltage to drive it.

The Hartley circuit is used, involving a tapped coil. Provided that it has a tap not too near one end any coil may be used here; a centre-tapped plug-in coil, if such is available, will be found the most convenient when it comes to changing the wave-range. Any condenser may be used for tuning it; in the absence of a tuning condenser of ordinary type a

reaction or a pre-set condenser of maximum capacity 0.0005 mfd. will be found perfectly satisfactory. The anode voltage required will depend largely upon the valve available; for a small power valve (220 P class) 9 to 15 volts will probably suffice, though a high-impedance valve may need as much as 40 or 50 volts. Since the oscillator is inclined to take a very heavy anode current, it is strongly recommended that the voltage used should be the lowest that will give satisfactory oscillation.

The remaining piece of apparatus that is needed is one that is almost certain to be in the possession of any constructor who is likely to tackle the job of matching coils—it is a milliammeter. The range it covers is almost immaterial, as it will be used only for detecting resonance by change of anode current, nor is it necessary that it should be a high-class meter of guaranteed accuracy.

The principle involved in the actual matching is to use each valve of the set in turn as a detector, connecting the milliammeter in the anode circuit in each case. A skeleton circuit of a receiver with two tuned high-frequency stages is given in Fig. 3; the process of making the individual adjustments necessary to ensure that the tuned circuits have almost laboratory perfection of matching will be described with reference to this particular set for the sake of making the description as clearly defined as possible.

We begin by providing a signal at a low wavelength from the oscillator, and tune it roughly by rotating C_1 , C_2 , and C_3 together on their common spindle. Then, with the meter in the anode circuit of V_1 , we adjust the trimmer across C_1 until maximum deflection of the needle is obtained. We now know that the first tuned circuit is accurately tuned to the

points on the scale. To check this, the oscillator is readjusted to give a signal which can be tuned in near the upper end of the receiver's tuning range, and the milliammeter, still connected in the anode circuit of V_3 , is watched. By turning the condenser spindle a maximum deflection can be observed, but a little thought will show that it no longer necessarily corresponds to the exact tuning point of the last tuned circuit. Instead, it corresponds to maximum signal on the grid of V_3 , which will be reached when the ganged condensers are set to give the best average tuning of the three tuned circuits.

Test Each Circuit in Turn.

By the exercise of a little ingenuity it is not difficult to put the first tuned circuits temporarily out of action, and so to make the setting of the ganged condenser depend only on the third circuit. Perhaps the easiest method is to shunt each of them with a resistance low enough in value to ensure that, while a signal will still be passed on to the third tuned circuit, the other two will tune so flatly that the setting of the gang condenser giving the greatest deflection will be determined entirely by the needs of the last circuit, the other two becoming practically aperiodic. Some 2,000 to 5,000 ohms will be found about right for the two resistances, and as they will have to be moved about before the process of checking and adjusting is finished it will be well to equip them with clips for speedy connection and removal. They may be connected directly across the first two sections of the ganged condenser, or, if more convenient, directly from grid of valve to earth.

Having noted the reading of the gang

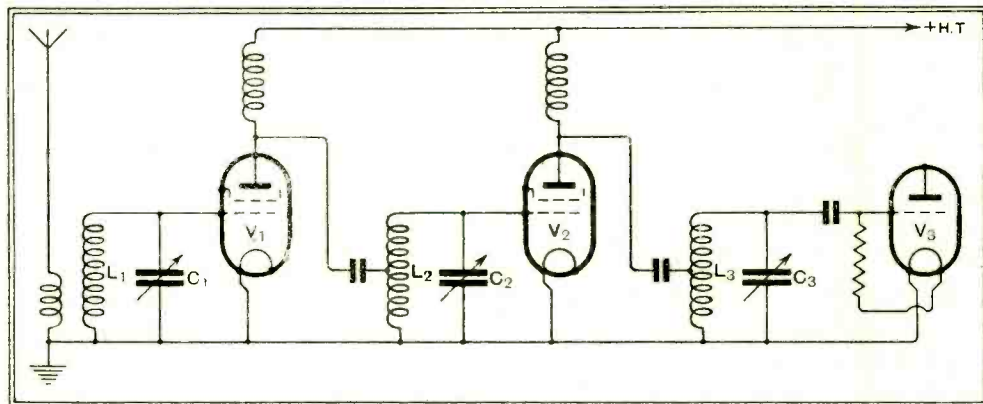

Fig. 3.—Skeleton diagram of receiver containing triple-gang condenser. A method of making the coils L_1 , L_2 and L_3 match exactly is described in the text, this receiver being taken as an example of the process used.

incoming signal. Leaving all else untouched, the meter is transferred to the anode circuit of V_2 , and the second trimmer is adjusted in the same way. Finally the meter is again moved, this time to V_3 , and the last trimmer is carefully set.

We now know that all three circuits are accurately tuned to the signal, and it follows that if the three tuning condensers and the three coils are exactly matched ganging will be perfect at all

condenser which tunes in the signal on the third circuit, the resistance is removed from the second condenser and clipped instead across the third, at the same time moving the milliammeter to the anode circuit of the second valve. The signal from the oscillator is again tuned in, and the reading of the dial, which shows the tuning point of the only unshunted circuit, the second, is noted. In the same way the tuning point of the first circuit is found, the resistances now being across

Matching Coils.—

C_2 and C_3 , and the milliammeter connected to V_1 .

Collecting the information obtained up to this stage, and inventing some likely figures by way of example, we now know:

- (a) That at 5° on the dial all circuits tune to the same wavelength, for we adjusted them to do so with the trimmers;
- and (b) That for some longer wavelength the tuning points are 93° , 96° , and 94° for first, second, and third tuned circuits respectively.

Assuming for the moment that all the condenser sections are perfectly matched, we have therefore found that the second circuit (the 96° one) requires a greater increase in capacity to tune from the low wavelength to the high than does either of the others. Consequently L_2 has a lower inductance than either L_1 or L_3 .

As it is easier to remove turns from a coil than to add them, we will bring the inductances of the other two coils down to that of L_2 , taking this as a standard.

Clearly, L_1 (93°) can stand more reduction of inductance than L_3 (94°); we will, therefore, begin by taking one turn off this coil as a trial correction. This will, of course, move the tuning points of the first tuned circuit in all positions of the dial; we must, therefore, reset the trimmer across C_1 at the low wavelength. The process of doing this has already been described, and it only needs to be repeated with the oscillator set at about the same wavelength as before; this time, for the sake of higher accuracy, we will clip the two resistances across the condensers not being adjusted while we retune each trimmer.

Making Small Changes in Inductance.

Reverting to the higher wavelength again, and finding the three tuning points as before, we may discover that, instead of the figures 93° , 96° , and 94° , we now have 95° , 96° , and 94° . The alteration to the coil has resulted in shifting the tuning point of the first tuned circuit from 93° to 95° .

This tells us at once that one turn on the coil is the correction required for an error of two degrees on the condenser at the wavelengths being used, thus providing a very definite basis on which to work. It is at once evident that L_3 , now tuning at 94° , will tune at 96° if we remove one turn, and we can do so at once without fear of seriously overshooting the mark.

But what do we do about L_1 ? Take off half a turn? Such a proceeding is possible, but introduces some uncertainty owing to moving the wires running from the end of the coil to the rest of the circuit; the extra length of this might quite well make up for much of the lost half-turn. A better scheme is to lengthen the coil by sliding the end turns a little outward towards the end of the former, which will make a small reduction in the in-

ductance. Moreover, such a mode of correction has the great advantage that it provides a continuous adjustment, so that the coils can be corrected, by small movements of the turns, to as high a degree of accuracy as we like to take the trouble to get.

After taking a turn off L_3 and shifting the end turns of L_1 a little, the process of trimming at a low wavelength and checking at a high wavelength is repeated, when it is found, let us imagine, that the dial readings have become 95.7° , 96° , and 96.1° .

denser-sections are not identical, all we know is that the coils have been adjusted to compensate for their variations at one point (at 96° in the example taken), and ganging may or may not be perfect at other points.

If it should turn out to be imperfect, there is nothing we can do about it unless we elect to start correcting the condensers by bending the vanes, which introduces more complications than can be dealt with towards the end of an article. But with all the apparatus at hand, it would be a strong-minded man indeed

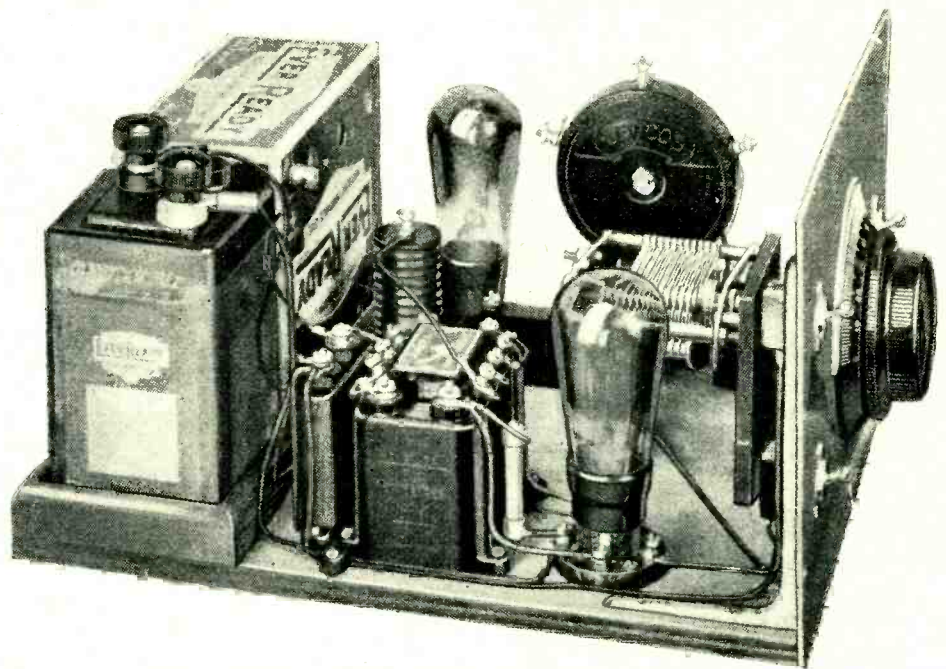

A useful modulated oscillator for ganging superheterodyne and straight receivers. Constructional details of this unit were given in last week's issue.

The error is now small, but once embarked on the task of matching the coils we naturally feel we may as well make a real job of it, and end up with absolutely perfect matching. On L_3 we have overshot the mark by a tenth of a degree in removing that one turn; if the remaining turns are still wound as closely as they will go we cannot retreat to 96.0° by squeezing the turns up, and must, therefore, make a trifling outward movement of the end turns of L_3 to bring that also up to 96.1° . As for L_1 , we notice that the last adjustment has more than halved the outstanding error, so that a further outward shift of the end turns, but this time a smaller shift, should be about right.

After making these alterations and retrimming at the short wavelength, we check, and at last find 96.1° , 96.1° , and 96.1° as the reward of our efforts. Or, if we do not achieve perfection this time, one or two more trials will see us at our goal.

At this stage we know for a certainty that ganging is absolutely perfect at the top and bottom ends of the tuning dial. If the condenser-sections are perfectly matched, then we have adjusted the coils to identical inductance values, and it will inevitably follow that ganging must be perfect at all intermediate points on the dial. But if, on the other hand, the con-

who could forbear to exercise his newly acquired skill by checking the accuracy of the ganging at, say, 50° , if only as a matter of interest.

To do so, the oscillator is set to give a wavelength that tunes in at about this point, and the exact tuning points of the three circuits are found by the same method that was used at the higher wavelength. The trimmers, be it noted, have already been set, and their adjustment must naturally not be altered.

Ganging on the Long Waves.

In estimating the effect of any error that may be found in the ganging during this closer examination of its perfection, it may be helpful to remember that with a 100-degree dial an error of one degree implies that the circuit concerned is tuned about 10 kc. away from the station with which the others are in resonance. Approximately, that is, to the next station on the list. On a 180-degree dial each degree naturally represents a lesser error—about 6 kc. Whether the error found in any particular case is, or is not, likely to be seriously detrimental to the performance of the receiver is a matter which must be left to the individual judgment of the user, who will have to take into account the degree of selectivity and sensitivity needed in his particular locality.

High Inductance Smoothing Choke.—

When assembling the core all the "T"-shaped stampings must be inserted from the same side and the square hole in the bobbin filled to its capacity. They should be packed as tightly as possible, even though this necessitates lightly tapping home the last one or two.

The "U" members can then be assembled, using as many of these as there are "T" pieces, thus forming an exact number of pairs. Fit the end-clamps and retaining bolts, but run the nuts on finger-tight only at this stage. Before closing up the two gaps in the side limbs of the core, insert a piece of insulating material—its nature is of no consequence—0.02in. thick and in width slightly less than that of the core, so as to allow for contraction when the stamping nuts are tightened. Material of this thickness is equivalent to No. 24 s.w.g. approximately.

At this stage four small strips of wood should be prepared and forced in between the clamping bolts and the core, their function being to prevent the air gaps from opening and so altering the characteristics of the choke.

It remains now only to prepare a terminal strip, for which either ebonite or Paxolin can be used. This is fixed to the extensions on the top clamping bolts by two additional nuts. The fixed resistor can be mounted on this quite conveniently in the manner shown in the detailed drawing and in the title illustration.

"News by Television."

MESSRS. BAIRD TELEVISION, LTD., in drawing attention to the article, "News by Television," describing the new Marconi apparatus in our issue of August 5th, state that a similar device was in regular operation in connection with their broadcast programmes, and was described in "Television" for November, 1930, a continuous message being broadcast by means of a tape pulled past the scanned area at a low speed. The Company adds that the apparatus is described in British Patent No. 324,029.

We are informed by the Marconi Company that their apparatus is designed solely for the purpose of transmitting one type of picture—a long strip of transparent tape which fills the whole of the frame, this being the central feature which controls the general mechanical design of the apparatus.

The electrical design is based fundamentally on the frequency band available for the television transmission, and this determines the length of the frame for a given picture frequency and number of scan lines per picture. The object in view is to transmit the maximum amount of intelligence possible in a given picture area determined in this way, and this results in the use of straight line scanning, preferably along the length of the picture.

The Marconi Company adds that the apparatus is covered by British Patent No. 373,288.

DISTANT RECEPTION NOTES.

A Useful Frame Aerial Hint.

THE greatest enemy of long-distance listening during the summer of 1932 was atmospheric interference, and this is still with us to some extent. There is no means of entirely eliminating the interference produced by the heavily damped wave trains of atmospheric, but there is a method of dodging it which I often find very useful. Atmospheric frequently originate in a well-defined disturbance centre and arrive therefore from one direction. Everyone knows that the frame aerial has directional properties, but it is not always realised that the most marked of these is that signal strength is at its minimum when the frame is turned so that its windings are at right angles to an imaginary straight line joining receiving station and transmitting centre. This property can be made use of when atmospheric come from a particular area.

Using the Frame.

One great "hotbed" of atmospheric is Northern Africa, and interference from this centre arrives from a southerly direction. By turning the frame so that it points roughly east and west it will often be found that interference is enormously reduced. In any case, the method is first of all to discover whether there is a minimum-interference setting of the frame, and, if so, to adjust it carefully. Long-distance reception is then mainly confined to stations within the purview of the frame when set in this way. It luckily happens that some of the best Continental stations are situated in the eastward; when, therefore, interference comes from a southerly direction the number from which a selection can be made and whose programmes can be received almost, if not entirely, clear of interference is considerable.

It is very interesting to note the way in which stations that have not been receivable for many weeks now begin to reappear in one's records of reception. Madrid Union Radio is a notable example. The station comes into operation at 7 p.m., but shares a wavelength with Moscow-Stalino. It is only after the Russian station has closed down that Madrid can be heard, but late in the evening I have obtained excellent reception. Budapest is a second station now returning to strength. Full loud speaker volume has been obtainable on many recent evenings. Others of which little or nothing was heard in June, July, and August, but which now become better and better received, are Vienna, Lyons, Doua, Belgrade, Moravska-Ostrava, and Leipzig.

Good Stations.

Last week I gave a list of a dozen reliable foreign stations on the medium waveband and mentioned that there were many others which might be regarded as "odds-on chances" rather than "certainties." Here are some which fall into the latter category at the present time. Florence on 500.8 metres is a very much improved signal, though strength still varies somewhat from night to night. Prague on 488.6 metres shows small variations, but is almost always a good signal. Stockholm on 435.4 metres is rapidly becoming as good as Rome. Katowice on 408.7 metres is well received on many evenings. Sottens on 403.8 metres is occasionally good, but there are still evenings when this station is almost inaudible. Frankfurt on 389.6 metres gives good reception when free from heterodyne interference. Breslau is strengthening up and frequently provides excellent reception.

D. EXER.

A WELL-KNOWN FOREIGN STATION.

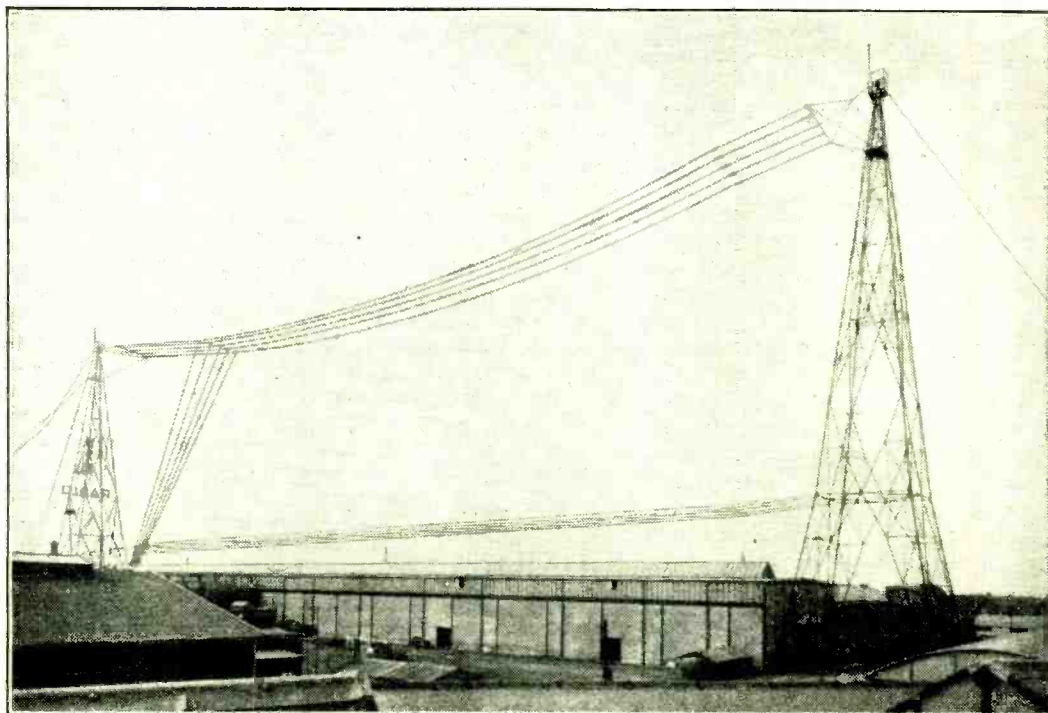

The Dutch station at Hilversum which transmits on 1875 metres and exchanges wavelengths with Huizen every three months.

UNBIASED

By FREE GRID.

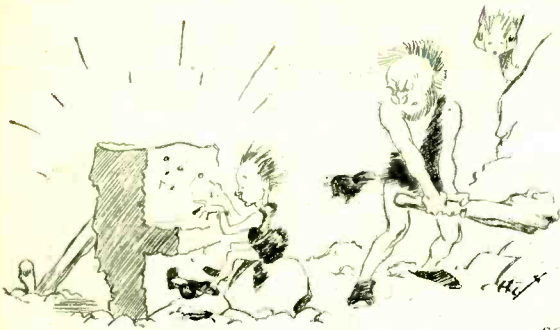

Before wireless was heard of.

The Case of a Dentist.

I SEE by the newspapers that a dentist has been successfully sued by an indignant neighbour for creating a disturbance by operating, or permitting to be operated, a loud speaker at such volume that it destroyed the repose of the aforementioned neighbour on the other side of the party wall. The dentist is now reported to be taking counsel's opinion whether he would be likely to succeed in an action against the jerrybuilder who put up the house.

This matter seems at first sight very trifling and insignificant, but since, as one journal points out, it is the first time an action of this kind has been successfully brought in the case of a loud speaker used in a private dwelling house, it is actually of the utmost importance and opens up possibilities of suppressing forms of interference which were troubling mankind years before wireless was heard of.

No longer shall we have to put up with the perpetration of the "Turkish Patrol" by the wretched child next door, as it will only be necessary to sue the parents in order to cause the child and its pestiferous piano-playing to pass into merciful oblivion. Needless to say, the depraved creatures who insist on taking their loud speakers into the garden will be among the first to be swiped.

The greatest advantage of all which the success of this action gives to the broadcast listener, however, is that it gives a precedent for bringing an action against people owning advertising signs, face lifters, fans, trams, and all the other electrical paraphernalia which make life scarcely worth living for the wireless enthusiast.

A Wild Goose Chase.

THE period of the year now with us, when radio exhibitions break out in spots over the surface of the earth like measles, is always my busy time, as I make it an invariable rule to visit every one which is within a thousand miles' radius of London. I must, therefore, crave the indulgence of my numerous correspondents if replies are rather delayed or are short and sweet, like a donkey's gallop. Like Mr. Squeers, I give everyone individual attention, and everyone gets a personal reply, but do not forget that, like Henry Hall and Co., I have my own "signature," and no ebullitions are genuine without it.

This year I have missed the Berlin Show owing to a most foolish mistake on my part. As you probably know, the opening date of the Berlin Show coincided with that of Olympia, but it continued for one day longer. The Paris Show, on the other hand, will be held during the second week in September. Unfortunately I confused the two, and as

soon as Olympia closed last Saturday night I made a dash for Victoria, en route for the night service between Folkestone and Dunkerque, intending to devote Sunday to the Paris Show. Having arrived in the once-gay city, I sped as fast as a French Jehu could take me to the scene of action.

To my astonishment I found no radio show at all, and after a heated but halting argument with a fierce looking individual in a gaily coloured uniform, the horrible truth dawned on me. The exhibition which I had come to see was over umpteen hundred miles away, and not even an aeroplane could get me there in time. Taking sorrowful leave of my much beribboned informant, who, judging by his uniform, may have been anything from a postman to a Marshal of France, I



No radio show at all!

wended my way slowly to the nearest café, where I sought repose until the time came for me to catch my train at the Gare du Nord. I have made a firm resolve that in future I would buy a copy of *The Wireless World* Diary rather than rely upon my memory.

I feel so dispirited about it that I wonder if I shall have the energy to go back to Paris in September; and for two pins (type split, valve for the use of) I would exceed my thousand-mile limit and buzz off to the New York Show, which I have not visited since 1929.

Wire for Sale?

MUCH acid comment has been made by the inhabitants of Geordieland, in letters written to the editors of local journals, concerning their inability to receive the Newcastle station since it swooped down to its present low wavelength. I think that an epistle from an individual who signs himself with the age-old *nom de plume* "Disgusted" just about takes the biscuit, or whatever it is that they *do* take in that part

of the country. After delivering himself of a diatribe concerning the B.B.C. and its clarty tricks, he demands to know why he and all his fellow Geordies should be compelled to go to the expense of altering their crystal sets just to please the mandarins of the B.B.C.

Surely "Disgusted" and his friends should know that, so far from causing them expense, the B.B.C. is actually putting money into their pockets by releasing some of their capital which is at present tied up in their sets in the form of superfluous copper wire.

The Parish Pump.

JUDGING from the remarks made by the Radio Editor of one of our northern journals, people up that way are thoroughly dissatisfied with the North of England news bulletin. Having listened to this delectable item once or twice myself, I must say that I entirely sympathise. The Regional news from London is usually dull and uninteresting, but from experience of both I really do think that it does not touch such depths of parochialism as does its northern counterpart, which descends to such paltry statistics as the number of library books issued in Salford, and the amount of fish and chips sold in Blackpool over a given period.

At the risk of being unmasked and put on the spot when I visit the Manchester Show, I must place on record the views given to me by a well-known B.B.C. official—no, not the chief charlady this time—when I put the point to him. He stated that experience had definitely proved that the people of the north were more parochially minded than those of the south, and while southerners would be entirely disinterested in the amount of lip-stick used annually in Tooting, similar details regarding Bootle would be welcomed in the north.



Erighter news bulletins.

I pointed out to him that the views of the northern editor were diametrically opposed to his, but he parried by stating that in all probability the editor was not a true northerner but merely a transplanted southerner who knew no better.

NEWS of the WEEK

Current Events in Brief Review.

A Happy Testing Ground.

THE village of South Mimms, near Brookmans Park, is becoming a favourite spot for testing the selectivity of receivers, as, in addition to being almost under the shadow of the B.B.C. aërials, it is the only village in the neighbourhood with alternating current mains.

Radiolympia Results.

THE Olympia Exhibition has proved an undoubted success from the point of view of the manufacturers. It is stated that orders to the value of £50,000,000 have resulted, as compared with £29,000,000 last year, and it is estimated that the new business secured will probably give employment to 20,000 extra workpeople.

Automatic S O S Device.

EXPERIMENTS are being carried out at Hamburg with a new form of apparatus intended for vessels which are not equipped with wireless whereby SOS signals and the name and position of the ship are sent out by means of a spark transmitter supplied with current from a hand-driven dynamo.

Cunard Company's Ship Installations.

THE Cunard Company, who for years past have operated and maintained the wireless services on their vessels, announce that they have now entered into an agreement with the International Marine Radio Company to carry out these services in the near future.

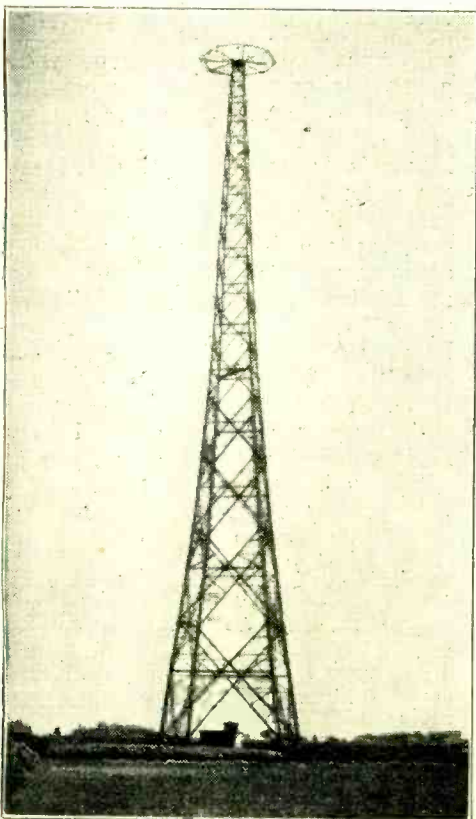

Mast of the new high-power station at Breslau, showing umbrella-shaped top of the vertical aerial.

TO MADRID. Members of the B.B.C. who are attending the International Radio Telegraph Convention now being held in Madrid. Mr. Noel Ashbridge, the chief engineer, is seen on the left with Vice Admiral Sir Charles Cappendale, the controller of the B.B.C., and Mr. L. W. Hayes.

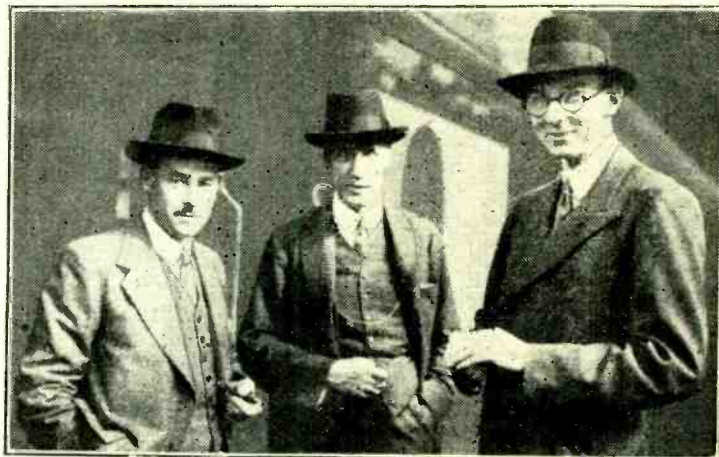

The Madrid Conference.

IMPORTANT developments may be expected to result from the International Radio Telegraph Convention, which opened in Madrid this month. The Post Office is represented by Mr. F. W. Phillips, the chief of the telegraphic department and Assistant Secretary to the G.P.O., together with Col. A. S. Angwin, Mr. F. Stroug, and Mr. B. L. Barnett, while the Admiralty, War Office, Board of Trade, Air Ministry, and the B.B.C. have also sent delegates.

Wavelength Problem.

PROBABLY the most vital question being discussed is the allocation of wavelengths both for broadcasting and for amateur experimenters. The Union Internationale de Radiodiffusion, in view of the present congestion of broadcasting wavelengths in Europe, is said to cast envious eyes upon some of the wavelengths at present used by the mobile services, while amateurs are anxious to obtain the exclusive rights to wavelengths which they now share with other services, as well as additional wavebands in the ultra-high-frequency region.

Amateur Representatives.

THE claims of amateur transmitters are being urged by Mr. K. B. Warner and Mr. P. M. Segal, of the American Radio Relay League, who will remain at Madrid during the whole Conference, while the R.S.G.B. is represented by its Acting Vice-President, Mr. A. E. Watts, and the Spanish Association E.A.R. by Mr. Miguel Moya, so the various contending elements are not lacking able advocates to safeguard as far as possible their respective interests.

More Power for Freiburg.

THE German Postal Authorities have bought a house in the village of Betzenhausen, about 3 kilometres distant from Freiburg-im-Breisgau, where they intend erecting a new transmitter having an output of 5 kilowatts to the aerial which, it is hoped, will be ready early next spring to take the place of the present quarter-kilowatt relay station.

Drastic Measures with Man-made Statics.

THE Roumanian Government has passed a law making it compulsory for all electrical apparatus to be guaranteed free from

danger of interference with radio sets, and even apparatus at present in use must be rendered innocuous within two months from the publication of this law. Penalties ranging from 3,000 to 15,000 francs will be imposed on delinquents, and every listener will have the right to claim damages from owners of motors, etc., that interfere with his reception.

Germany's New High-power Station.

THE new station at Breslau, which was formally opened on August 28th, is rated at 60 kilowatts, and transmits on a wavelength of 325 metres. The aerial is of an unusual type, consisting of a vertical wire suspended within a wooden tower and having an umbrella-shaped top, whose function is to increase the effective range of the ground wave by changing the angle of the reflected wave.

Stolen Goods.

THE Automatic Coil Winder and Electrical Equipment Co., Ltd., of Winder House, Douglas Street, S.W.1, offer a reward of £50 for information that will lead to the conviction of the thief and the recovery of the Universal Avometer which was stolen from their stand at Radiolympia on the night of August 24th; the number on the scale plate was 82-375. As this was the only completed instrument on their stand and was with forty other Avometers, it is evident that the person who took it knew what he wanted!

The Wireless World INFORMATION BUREAU.

Conditions of the Service.

THE service is intended primarily for readers meeting with difficulties in the construction, adjustment, operation, or maintenance of wireless receivers described in *The Wireless World*, or those of commercial design which from time to time are reviewed in the pages of *The Wireless World*. Every endeavour will be made to deal with queries on all wireless matters, provided that they are of such a nature that they can be dealt with satisfactorily in a letter.

Communications should be addressed to *The Wireless World* Information Bureau, Dorset House, Tudor Street, E.C.4, and must be accompanied by a remittance of 5s. to cover the cost of the service. The enquirer's name and address should be written in block letters at the top of all communications.

NUTS TO CRACK.

Instructive Problems and their Solution.

THE present series has been started by *The Wireless World* for the benefit of readers who like to work out little problems for themselves and be sure that the results they obtain are correct. At frequent intervals wireless problems are presented, and in the following instalment the answers are given with the methods of working them out, and hints on possible points of difficulty. Problems 62, 63 and 64 have already been given, and below the answers appear, whilst another set of problems is included this week for treatment in the next instalment.

QUESTION 62.—An electric lamp is marked 40-watt 220-volt. What current will it take from 220-volt D.C. mains, and what resistance will it have at that voltage? What further specification would be required before employing such a lamp in a D.C. mains receiver?

Answer—0.182 amp., 1,210 ohms. Filament current and voltage of set must be known, also the voltage-current characteristic of the lamp.

It is now fairly common in D.C. mains sets to employ electric light "bulbs" to drop the mains voltage to an amount suitable for the filament supply. Unfortunately, however, the question of selection is complicated by the fact that, when so used, the full mains voltage is not effective across the lamp. The result is that a considerably smaller current may flow than would be the case if the lamp was used simply for its normal lighting purpose.

The present question refers to the current and resistance of the lamp at 220 volts; there is here, therefore, no question of employing it as a "voltage-reducer." The fundamental formula relating the power taken by a given resistance to the D.C. voltage across it is $W = E^2/R$, where W is in watts and E and R are in volts and ohms respectively. For the lamp in question, $W = 40$ and $E = 220$. Therefore, we may write $40 = (220)^2/R$, whence

$$R = (220)^2/40 = 1,210 \text{ ohms.}$$

The current taken by the lamp is obviously given by E/R amperes, i.e., it is $220/1,210$, or 0.182 ampere.

Before the lamp could be employed as a voltage-reducing resistance for a D.C. mains receiver we should first require to know the voltage and current necessary to operate the valve filaments—usually connected in series. The actual voltage across the lamp would then be the difference between the filament voltage and that of the supply. Finally, we should require to know the current actually taken by the lamp at this reduced voltage. If this current were approximately the same as that taken by the filaments, the lamp would be suitable; if not, another type would have to be employed. For further information on this subject, and also on the difference between the properties of carbon- and metal-filament lamps, readers are advised to consult the article, "Lamp Resistances for D.C.

Receivers," which appeared in the issue of 8th June last.

QUESTION 63.—For a certain double-range voltmeter a current of 2 mA. gives a full-scale deflection on both the 6-volt and 250-volt ranges. What is the rated resistance in ohms per volt for the two cases?

Answer—500 ohms per volt in each case.

Those readers who are well versed in voltmeter lore will have no difficulty in giving the above answer "pat." For the benefit of those who may not have seen the short cut, we shall take a longer way round, as follows: The resistance R of the meter in ohms is given by the fraction E/I where E volts is the P.D. across the terminals for maximum current I amps.

For the 6-volt range, therefore,

$$R = E/I = 6/0.002 = 3,000 \text{ ohms.}$$

Thus the required resistance per volt is $3,000/6$, or 500 ohms per volt.

Again, for the 250-volt range,

$$R = E/I = 250/0.002 = 125,000 \text{ ohms.}$$

Thus the required resistance per volt is $125,000/250$, or 500 ohms per volt.

A little reflection on the identity of these two results should bring to light the short cut alluded to above. A current of a certain amperage may be specified in a more round-about fashion by stating the voltage-drop which it will cause when flowing through a certain number of ohms resistance. Since $I = E/R$, we see that a current of, say, 4 amperes is equivalent to 12 volts per 3 ohms, or to 4 volts per ohm, since this current passing through 3 ohms will set up a P.D. of 12 volts. Now, fairly elementary arithmetic will show that if we have a certain number n of the units "volts per ohm," this will be equivalent to $1/n$ of the reciprocal unit "ohms per volt." (If you doubt this, just try the effect of substituting apples and pence for volts and ohms, when the principle should become clear.) Accordingly, the number of "ohms per volt" corresponding to a given current is the reciprocal of the number of amperes composing it. In our example the full-scale current taken by the meter in each case is 0.002 ampere, that is, 0.002 volt per ohm. Taking the reciprocal, therefore, this is equivalent to $1/0.002$, or 500 ohms per volt, no further calculation being required.

QUESTION 64.—The H.F. current at 300 kc. in a certain reaction primary coil is known to contain a 15 per cent. third harmonic. If the fundamental frequency E.M.F. induced in the coupled coil has an amplitude of 12 mV., what will be the induced E.M.F. of the third harmonic?

Answer—5.4 mV.

When two coils are in proximity and an alternating current is made to pass through one, a corresponding alternating E.M.F. is "induced" or set up in the other. This

important fact, which has now been known for just over a century, is the basis of all high-frequency current engineering, and without it such familiar wireless devices as coupled band-pass tuning, magnetic reaction, and transformers of all kinds could not exist. The magnitude of the E.M.F. set up in the secondary coil is proportional to the amplitude of the current in the primary and also to its frequency; this latter fact is important, since it thus appears that if the frequency of the primary current is doubled, not only will the induced E.M.F. be doubled in frequency to correspond, but its amplitude will actually be doubled also! In symbols we may write

$$E = I \times f \times M,$$

where E is the magnitude of the induced E.M.F., I is the amplitude of the primary current, f is the frequency of the current oscillations, and M is a constant depending on the construction and relative positions of the two coils (the mutual inductance).

This dependence of induced voltage amplitude on frequency has some importance in the study of reaction effects, because H.F. currents are not usually oscillating at one single frequency, but may often contain one or more "harmonics" of a fundamental frequency. The frequencies of these harmonic oscillations are all multiples of the fundamental frequency, though in general their amplitudes are very much less. In the example now under consideration the third harmonic of the fundamental frequency current will have a frequency of 3×300 kc., or 900 kc. Its amplitude, however, is much smaller than that of its fundamental, being indeed only 15 per cent. of it.

Turning now to the voltage-inducing effect of this small third harmonic current, we see that it will be relatively three times as large as the similar effect in the case of the fundamental, due to the increased frequency. The induced E.M.F. due to the third harmonic will thus be not 15 per cent., but 3×15 per cent., or 45 per cent. of the induced E.M.F. due to the fundamental. Hence the induced E.M.F. of the third harmonic is 45 per cent. of 12 mV., or 5.4 mV.

It should, however, be noticed that if the coupling coil is associated with a tuned acceptor circuit (usually tuned to the fundamental frequency), the actual "third harmonic" current resulting in the circuit will be very small indeed. Such a circuit will only "accept" currents of the frequency to which it is tuned, and the currents of the harmonic frequencies will be rejected. Such a tuned circuit thus acts as a filter which effectively counteracts the tendency of the ordinary untuned reaction coil to magnify harmonics.

NEXT SERIES OF PROBLEMS

QUESTION 65.—A small power valve has simultaneous values of (v_g, v_a, i_a) as follows: (0, 75, 9), (0, 100, 15), (-5, 100, 7), (-5, 125, 12), (-10, 125, 5), (-10, 150, 10)—the values of v_g and v_a being in volts and of i_a in mA. Sketch the course of the anode volts—anode current characteristics over this range.

QUESTION 66.—This valve is worked into a load of dynamic resistance 5,000 ohms, the mean potential at the anode being 110 volts and grid bias 5 volts. What A.C. power is taken by the load for a signal input of 5 volts (peak) on the grid?

NUTCRACKER.

The Studio Code.

HERE is as pretty a crop of digital studies as ever graced the walls of a thieves' kitchen or the bookie 'tic-tacs' enclosure at Ascot. Old lags will think they recognise the *cave canem* and the "ware, mates; here comes the radio-equipped police car," while the sporting gentlemen will clearly distinguish between the "shortened-odds-on-the-favourite" sign and the simple "op it."

It will set their minds at rest to learn that none of these contingencies is indicated, despite appearances. The most menacing of all



Silence is at a premium in all broadcasting studios and those who control the programmes must resort to signs. Above: "Local station announcement." The upper and lower signs on the right indicate respectively a programme cut and "play more loudly."

signs—the clenched fist—means nothing more terrible than "play more loudly"; and as for the old Army "wash-out" sign, shown in the uppermost picture, this simply indicates that the programme must be brought to a conclusion. These and many other gesticulations go to form a code which has gradually secured acceptance in the broadcasting studios of the world.

The majority have their origin in the American broadcasting studios, where the hot pace and the split-second method of programme projection call for all kinds of ruses and expedients to ensure that the merchant sponsoring the programme can obtain maximum results with a minimum of rehearsal. Nevertheless, most of the signs employed can be used with advantage at all broadcasting stations. Too often in this country and on the Continent there is a tendency to rely on the control engineer to perform the impossible task of correcting errors of balance in the studio, when a little prearranged gesticulation, however undignified it may appear

to the honourable studio audience, would make all the difference between a passable and a bad result at the listener's loud speaker.

Some of the hand signs are self-explanatory; no one could mistake the meaning of the sign shown below in which the hands, drawn slowly together with fingers turned in and thumbs up, make the mute request that the speaker or singer should come nearer to the microphone. There are other signs, however, which might well suggest to the casual

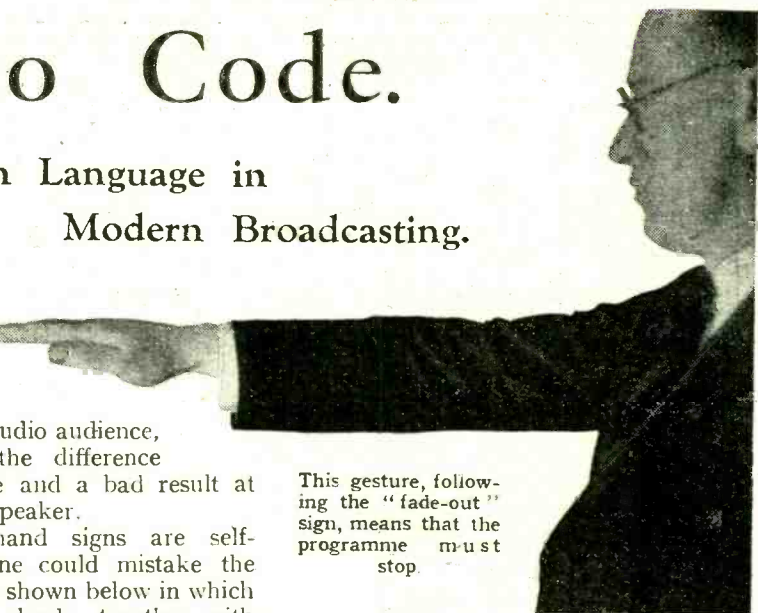

This gesture, following the "fade-out" sign, means that the programme must stop.

visitor that the announcer is either trying to be funny or is practising the old-fashioned mural drama in which the shadows of ducks' heads are miraculously transformed into those of rabbits or sucking pigs. For example, there is the "cut-the-programme" sign, which no novice would ever interpret. Two fingers are worked in a shearing motion. When a programme of the American National Broadcasting Company is running according to schedule the producer plants a finger firmly

against the side of his nose. Then he may call for a "fade-out" by half-closing his hand. Alternatively, he may be blissfully maintaining the pressure on his nose when a "productions" man suddenly begins waving his hand in circles; this is the sign that the programme is lagging and must be speeded up. ("Who's Beethoven, anyway?") And so to more gesticulation.

Perhaps the networks are to be synchronised, whereupon an engineer will assert himself by crossing the fingers of one hand against those of the other. Or a local announcement may be necessary, in which case a hand is extended

with the thumb and first finger at right angles.

On the face of it, it seems an anachronism that broadcasting—the youngest of the arts—should resuscitate one of the earliest forms of human communication. It would seem a more businesslike procedure to install illuminated signs or printed indicators in order to convey silent messages across the studio; yet these methods have been tried, and, strangely enough, have been found unsuccessful.

A possible explanation is that no printed slip or mechanical sign can attract the attention of the performing artiste quite so effectively as the human hand, which is, indeed, so compelling in its effect on the conscious and subconscious mind that a painted image of it is still used in public places to prompt the ordinary man to digress from his course.

For the present, at all events, hand



The left hand sign means "fade out." Above: "Draw closer to microphone."

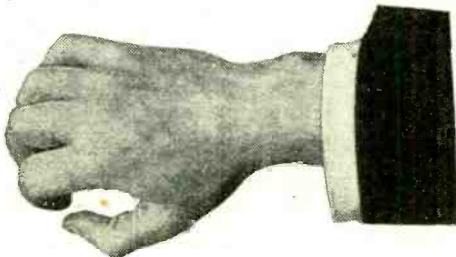

signals must serve, but it is interesting to speculate upon what new system will have to be used on the television stage.

Will the telecasting engineers and producers of future decades pep up the artistes with ultra-short waves?

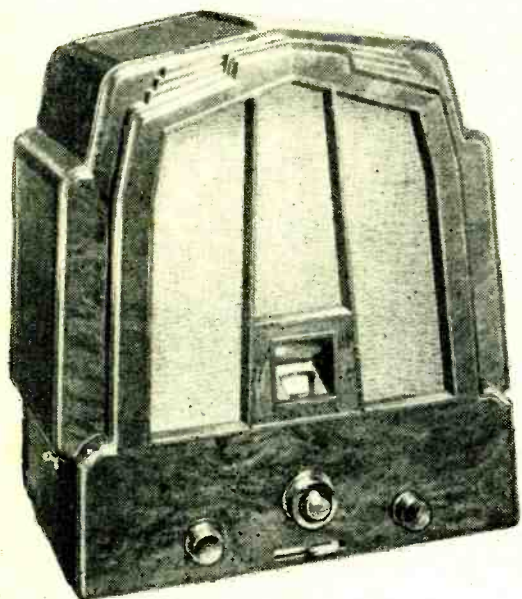

EKCO THREE-VALVE CONSOLETTTE.

Model M.23
for A.C. Mains.

A Self-contained Set with a Good All-round Performance.

IN these days the three-valve all-electric type of receiver is so well represented that very exceptional qualities are required to raise any particular make from the ruck. The Ekco Model M.23 gets off the mark well with a compact and well-proportioned moulded bakelite cabinet which itself encourages further acquaintance with the set. It may be accurately described as a self-contained receiver, for there is a choice of two internal aerials in addition to provision for an outdoor aerial, and the loud speaker—a permanent-magnet moving coil—is fitted inside the cabinet.

The tuning scale is calibrated in wavelengths, and our tests showed that an accuracy within one or two metres of the published wavelengths of stations could be relied upon at all parts of the scale. In no case was there the least difficulty in identifying a station from its wavelength setting. The main tuning control is fitted with a concentric trimmer, by means of which accurate alignment of the tuning circuits may be checked. On the right there is a reaction control, and on the left a combined selectivity and volume control, which regulates the aerial input.

Range and Selectivity.

The set is capable of a most versatile performance. Using the internal aerial (a short length of wire attached to the back panel), and without any special concentration in the adjustment of the controls, seventeen stations were received at full volume on the medium waveband. With so small an aerial an equivalent performance is not to be expected on long waves, but Daventry, Eiffel Tower, and Radio Paris were received at moderate volume.

The capabilities of the set and the full value of the input volume control are not appreciated, however, until the receiver is connected to a good outdoor aerial. The performance under these conditions gives striking proof of the adaptability of the set to local conditions.

With a 50ft. outdoor aerial at a distance of five miles from Brookmans Park, both transmitters could be cut down to a mere whisper and were quite inaudible when

detuned by about 10 metres on either side of their normal setting. By increasing the volume control by about a quarter of its maximum range of movement from minimum, no fewer than six stations could be received at full loud speaker strength between London National and London Regional with both stations working. Trieste (247 metres) and Heilsberg (278 metres) were quite clear of London National, and there was no background from London Regional when receiving Post Parisien (328 metres) and Scottish National (376 metres). These results serve to indicate the high figure of merit for combined range and selectivity which has been achieved.

An equivalent performance is available on long waves, the range being sufficient to give ten reliable programmes, and the selectivity enabling Königswusterhausen to be received at full strength without any interference either from Daventry or Radio Paris.

In spite of the fact that the set was tested within sight of the aerials at Brookmans Park, there was not the slightest trace of "break through" at the lower end of the long-wave scale. Trouble from this source has been successfully eliminated by including a small inductance between the medium- and long-wave aerial coupling coils. This inductance is mounted underneath the base of the set outside the field of the aerial input transformer, and it will be seen from the circuit diagram that it is short-circuited together with the long-wave coupling coil when receiving on medium waves.

The arrangement of the input volume control, which contributes largely to the excellent performance of the set in the matter of its adaptability to local conditions as regards range and selectivity, will also be best understood by examining the circuit diagram. The medium-wave aerial coupling coil is centre-tapped, and the two ends are connected through variable condensers to the aerial terminal. The condenser on the right constitutes the selectivity and volume control on the front panel, while that on the left is a pre-set bakelite dielectric condenser which is adjusted at the works. When the two condensers are adjusted to the same value the current in the two halves of the coil cancels out, and an exceptionally low minimum volume is obtained.

The screen grid H.F. stage is coupled to the leaky grid detector by a tuned H.F. transformer to which reaction is applied by the well-known combined capacity and magnetic coupling. The pick-up terminals are in parallel with the grid leak, so that it is essential that the pick-up leads should

be removed when receiving radio signals. Transformer coupling is again employed between the detector and the pentode power valve.

High-tension current is derived through a half-wave Westinghouse metal rectifier. The smoothing choke is included in the negative lead and tapped to provide grid bias for the last valve. Special care has been taken to ensure that the set complies with the recommendations of the Institute of Electrical Engineers for the installation of wireless sets working from supply mains, and the method of adjusting the primary of the mains transformer to the supply voltage by means of an insulated short-circuiting plug is neat and accessible.

Quality of Reproduction.

The output valve delivers an ample reserve of volume to the permanent-magnet moving-coil loud speaker. The bass response is uniform and shows no trace of resonance, while nothing is lost when reproducing the higher instruments of the orchestra, including the triangle—an exceptionally severe test for reproduction in the upper register. The loud speaker is particularly good when dealing with solo instruments, and speech, when reduced to the normal level of the voice, is life-like.

To sum up, the versatility of the Ekco Model M.23 is the feature which raises it above the average three-valve mains receiver. On the internal aerial no special skill is required to tune in the principal 50-kilowatt European stations, while with an outdoor aerial the set responds to intelligent handling of the input volume and reaction in giving an exceptionally wide choice of stations in circumstances which normally might be expected to give rise to trouble from local station interference. It is a set which can be confidently recommended for use in any part of the country, even in districts adjacent to the high-powered B.B.C. stations.

FEATURES.

General.—A table-model all-electric receiver with built-in moving-coil loud speaker and provision for the attachment of a pick-up and an external loud speaker. Tuning dial calibrated in wavelengths.

Circuit.—Three valves. (1) Screen grid H.F. with input volume control and transformer coupling. (2) Leaky grid detector. (3) Power pentode. Westinghouse half-wave metal rectifier. Small internal aerial, mains aerial and provision for outdoor aerial.

Controls.—(1) Main tuning (with compensator). (2) Selectivity and volume control. (3) Reaction.

Price.—17 Guineas.

Makers.—E. K. Cole, Ltd., Ekco Works, Southend-on-Sea.

A SENSITIVE AND FLEXIBLE THREE-VALVE MAINS RECEIVER.

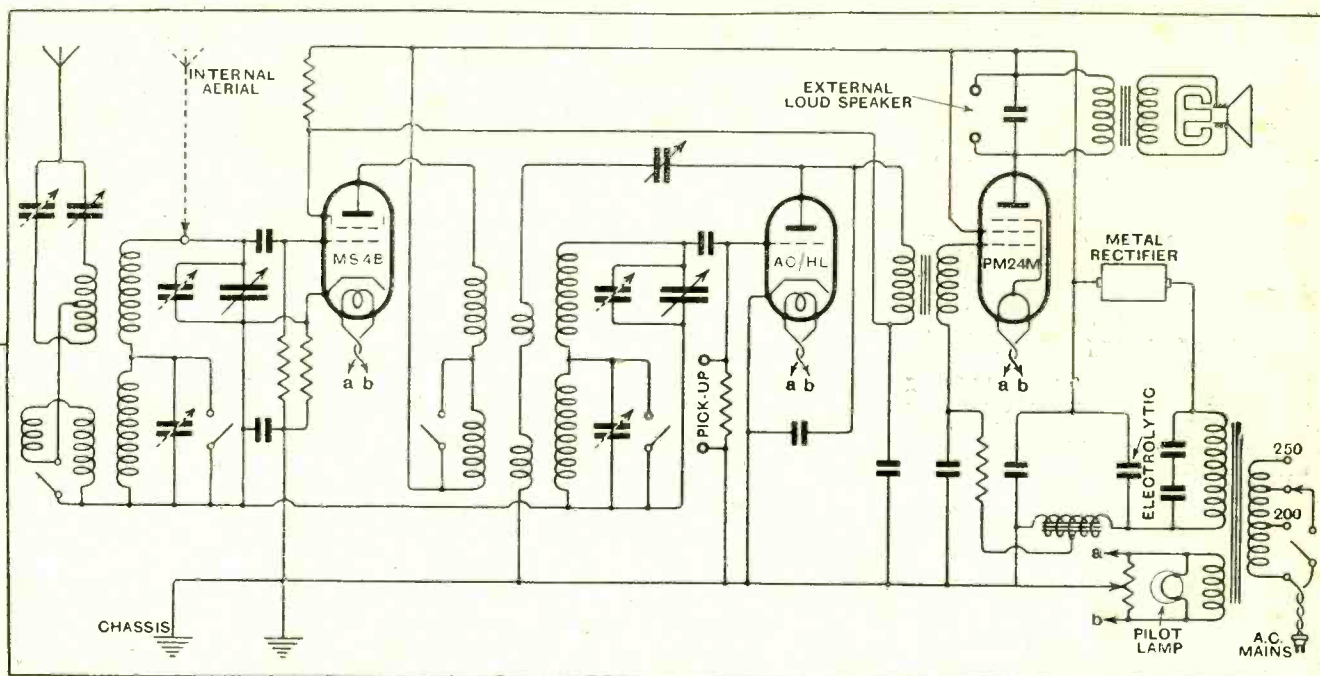

WESTINGHOUSE METAL RECTIFIER
C 13 HALF-WAVE

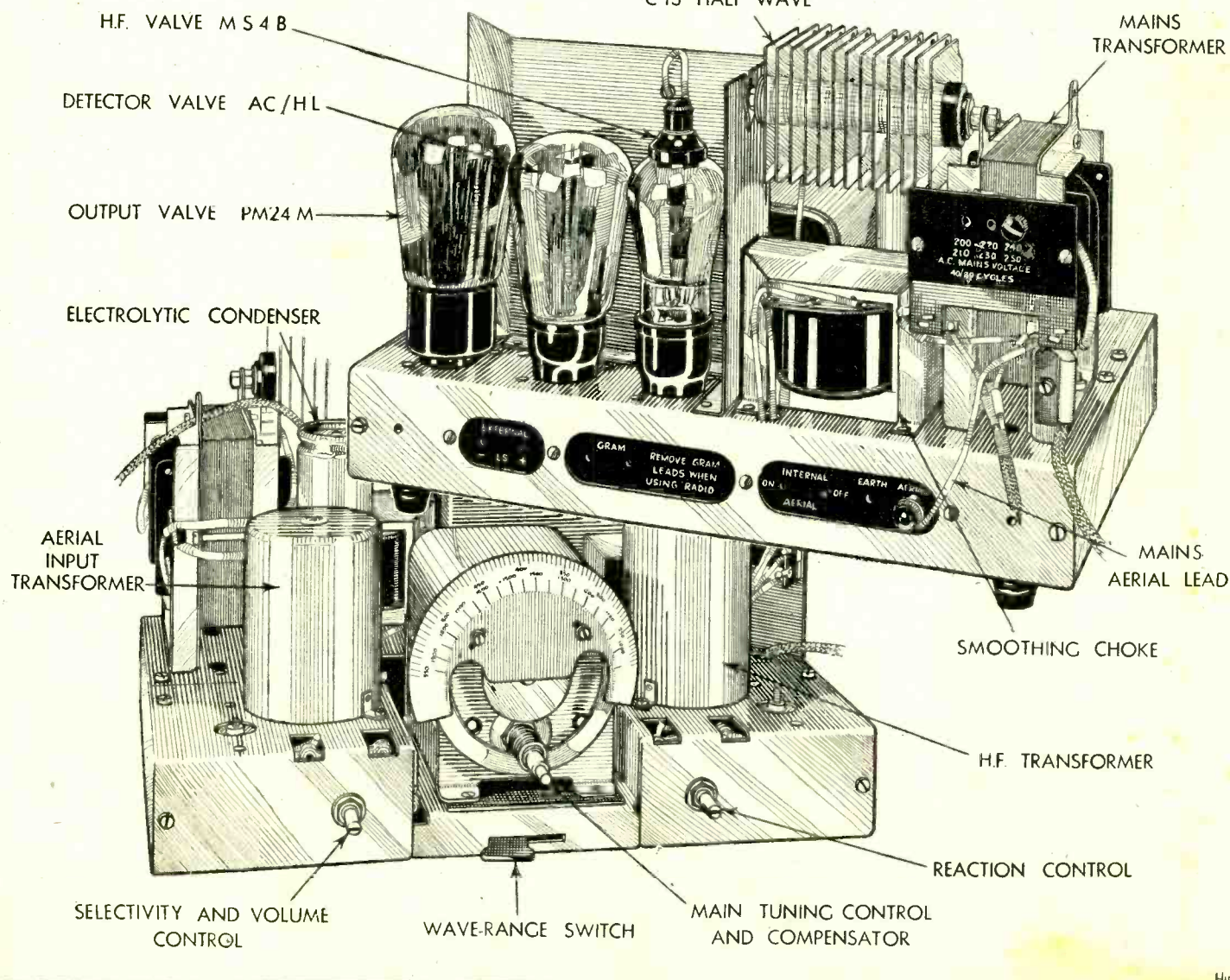

Circuit diagram and two views of the Ekco three-valve chassis incorporated in the model M.23 receiver.

PRACTICAL HINTS AND TIPS



Simplified Aids to Better Reception.

THE question of automatic bias for battery-fed valves is very much in the limelight at present; now that variable-mu H.F. amplifiers for direct heating have been introduced, it will naturally be desired to operate these new valves with-

Automatic Variable Bias.

out a separate bias battery. Fortunately, there is a fairly simple solution, which has already been touched upon in these pages, though not specifically in connection with the new type of H.F. valve. To obtain any bias voltage up to the maximum which has been legislated for in the output stage, it is merely necessary to shunt the main bias resistance with a potentiometer, to the slider of which the low-potential end of the H.F. grid circuit is connected. Provided the potentiometer has a resistance many times greater than that of the bias resistor, the voltage de-

veloped across the latter will not be affected to an appreciable extent. nents, the resistance and condenser associated with the H.F. stage may be of, respectively, 5,000 ohms and 0.1 mfd. Suitable values for use in the grid circuit of the output valve are 50,000 ohms and 1 mfd.

If it is desired to avoid the possibility of operating the H.F. valve with a "zero" grid, a bias-limiting resistance may be inserted at the point marked X.

This note cannot, unfortunately, be closed without referring to a possible "snag" with regard to automatic bias for variable-mu valves. The method suggested provides for a maximum bias voltage equal to that required for the output valve; if this be low it may be impossible to reduce sensitivity to a sufficient extent, at any rate when dealing with local station signals. This difficulty can be overcome, but the most obvious remedy will involve a sacrifice of H.T. voltage that may be too great to be economical.

A maximum of some 50,000 ohms is generally suitable for the resistance; its use will, of course, tend to reduce sensitivity, but this is seldom a drawback, as the average pick-up nowadays has a voltage output in excess of normal needs.

The connection of a shunt condenser has a similar effect, but may tend to introduce an objectionable resonance, and thus to defeat the object for which it is used.

THE present-day tendency to employ high-anode voltages in A.C. sets is increased by the fact that in many cases an extra 100 volts or so has to be provided to overcome the resistance of the loud speaker field coil, which is so often used as a smoothing choke.

Home-made Delay Action Switch.

When such a set is first switched on, an abnormally high voltage may momentarily be developed across the smoothing condensers; this is due to the fact that the rectifier may begin to function long before the cathodes of the receiving valves reach their operating temperature. The ill-effects of this rise of voltage are often countered by using a thermal delay switch, which does not allow the H.T. circuit to be completed until the cathodes of the receiver valves have commenced to emit.

A current of about 1 ampere is normally required to operate the delay switch; where this is not conveniently available, or where, for any other reason, the use of the ordinary type of switch is not desired, it is useful to know that a good measure of protection for the smoothing equipment generally can be obtained by arranging matters so that a loading resistance is placed across the main H.T. leads by the action of an automatic relay when the set is first switched on.

This can most conveniently be carried out by placing a break-circuit relay in series with the anode of the output valve, as shown in Fig. 2. The relay works in conjunction with the resistance R, of which the value may be chosen to pass about one-third of the anode current normally taken by the valves. When the set is switched on, the relay contacts will be

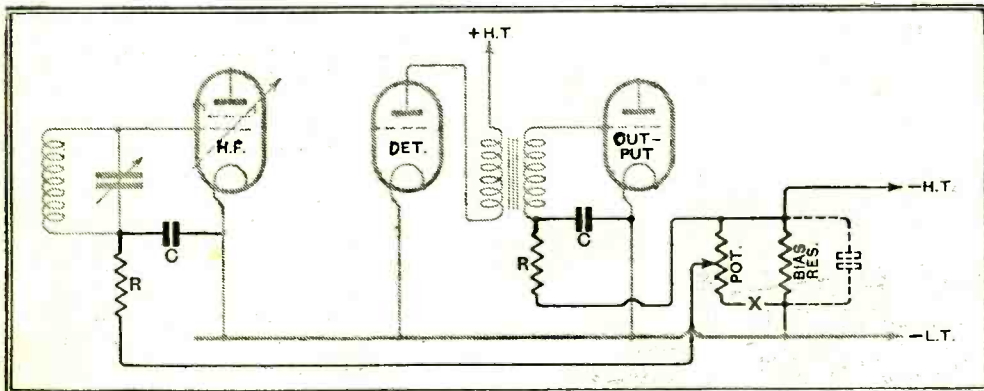

Fig. 1.—Controllable "free" bias for a variable-mu H.F. valve of the battery-operated type.

veloped across the latter will not be affected to an appreciable extent.

The appropriate connections for this system of adjustable bias are shown in Fig. 1, in which the positions of decoupling resistances and condensers, which will generally be necessary, or, at any rate, desirable, are indicated. The bias resistor may be shunted with a high-capacity condenser, of which the connections are shown in dotted lines; this condenser cannot be too large, and here we have an obvious use for one of the new "dry" electrolytic condensers with a high capacity but a low working voltage.

As to the value of decoupling compo-

FAIRLY elaborate filters are sometimes employed to restrict the high-frequency response of gramophone pick-ups, and thus to reduce needle-scratch. Although a good case can be made out for the use of these devices, it

Pick-up Tone Control.

may be borne in mind that the very-much-simpler alternative of a variable resistance, connected in shunt with the pick-up, is often surprisingly effective, and is always worth while trying when the use of a tone-lowering device is indicated.

Practical Hints and Tips.—

closed, and the resistance, being in circuit, will prevent an undue rise of voltage. But, as the output valve warms up to its work, the relay armature will be attracted, and the resistance will be cut out of circuit.

A suitable relay may easily be made from an electric bell mechanism, the only alteration necessary being the rewinding of the bobbins with thinner wire, and the provision of extra terminals; care should be taken to see that the back-contact pillar is well insulated from the frame. Generally speaking, the bobbin should be rewound to absorb between 0.1 and 0.25 watt, which will give quite a strong pull

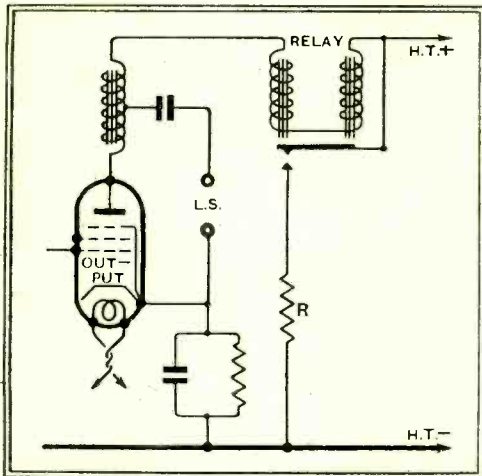

Fig. 2.—A self-acting relay, arranged to impose an artificial load on the H.T. rectifier while the receiver valves are warming up.

on the armature, and thus allow the use of sufficient back-spring to ensure good contact in the "closed" position.

It will be almost needless to add that the relay should be carefully insulated from "earth."

IN a well-designed modern receiver matters are usually so arranged that the undistorted output of the detector valve is just sufficient fully to load the succeeding valve—which, more often than not, is the output valve.

Increasing Detector Output.

may well fail to have the desired results. The reason, of course, is that the detector output remains unchanged, or, alternatively, if an increase can be obtained, it will not be free from distortion. Consequently, advantage cannot be taken of the increased power output of the new valve, as it will be impossible to load it properly.

A simple solution of this problem is occasionally to be found in a reduction in value of the detector feed resistance. By arranging to pass a few extra milliamperes in the anode circuit of this valve power output will be sensibly increased—but at the expense of valve life if matters are carried too far. Another possible objection is that the decoupling resistance will probably become ineffective for its primary purpose if it is reduced to such a

low value that it is not considerably greater than the reactance of the decoupling condenser at low frequencies.

THE ill-effects of parasitic oscillation in an output valve are generally appreciated, but it is not always realised that the occurrence of these oscillations may occasionally be responsible for the virtual destruction of a valve in an extremely short space of time. Further, there is the possibility that a set may be entirely free from parasitic oscillation when it is first put into operation, but the conditions for this trouble may develop later on.

A Safeguard for Output Valves.

low value that it is not considerably greater than the reactance of the decoupling condenser at low frequencies.

Accordingly, it is a good plan to make it a rule always to include anti-parasitic resistances in both grid and anode circuits, and not to wait for an indication that the trouble is actually present. As most readers will be aware, a resistance of 5,000 ohms is usually recommended for the grid circuit, and one of 100 ohms for insertion in series with the anode. Too much stress cannot be laid upon the fact that these resistances should be placed in the closest proximity to the valve-holder terminals; the inclusion of even an inch or so of wire may be enough to nullify their good effect. Finally, it should be pointed out that the tendency towards self-oscillation is greatest when high-power, high-efficiency valves are employed.

EDISWAN H.T. BATTERIES.

THE adoption of a new process in manufacture has enabled the Edison Swan Electric Co., Ltd., 123-125, Queen Victoria Street, London, E.C.4, to effect a considerable reduction in the prices of Ediswan H.T. batteries, and still maintain the high standard that characterises all Ediswan products. They are available in two types, viz., a standard capacity rated to give a maximum output of 10 mA, and a super size whose discharge rate is limited to 20 mA.

A 120-volt specimen of each type was subjected to our usual test, whereby the battery is discharged for periods of four hours each with similar time intervals for recuperation. Although not actually reproducing the conditions obtaining in practice, since the recuperative periods are of such short duration, this method accelerates the discharge of the battery and enables a very fair estimate of its qualities to be obtained within a reasonable period of time.

In each case the discharge was commenced at the maximum rate permissible for the battery, a loading resistance being used to adjust the initial current. The current flowing through the resistance was measured during the middle of the discharge period so that the curves give the mean voltage throughout the life of the battery. For convenience only the actual working hours are shown, the rest periods being omitted.

has fallen to 0.75 volt per cell. On this basis the standard capacity type gives 260 working hours, while the super size exhibits a slightly longer life, amounting to 290 hours.

Little advantage is gained by retaining the batteries in commission beyond the theoretical end-point, for it will be seen from the curves that the voltage falls very rapidly indeed, and the batteries are soon exhausted.

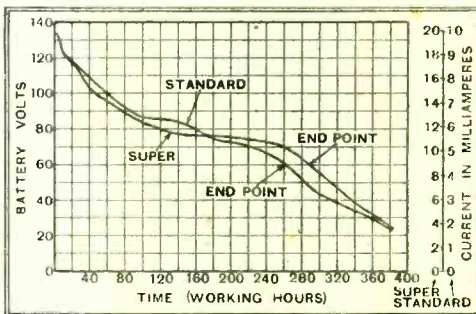

Discharge curves of Ediswan standard-capacity and super-capacity 120-volt dry cell H.T. batteries.

If the capacity of these batteries is calculated on a watt-hour basis the standard type will give 120.8 watt-hours, while the super size affords 252.5 watt-hours. Since each 120-volt unit contains 80 cells the watt-hours per cell are 1.5 and 3.2 respectively.

Under normal working conditions where the batteries are discharged at a rate approximating the maximum in each case at least three months' service may be expected, but at lower discharge rates the useful life of the batteries should be somewhat longer than this.

Ediswan batteries are made in standard capacities ranging from 60 volts to 120 volts with five intermediate sizes, the prices being 6s. 9d. for a 60-volt unit, and 13s. for 120 volts. The super capacity type cost 12s. 6d. for 60 volts, 21s. 9d. for 105 volts, and 25s. for 120 volts.



Standard-capacity size Ediswan H.T. Batteries.

These curves bear testimony to the consistency of manufacture, and exemplify the care given to the choice of suitable sized cells to assure a comparable performance with both types of batteries provided the maximum discharge rate assigned to each is not exceeded.

The end-point of the batteries under review is taken to be where the potential

Next Week's Set Review:—

TRIX 50-WATT POWER AMPLIFIER

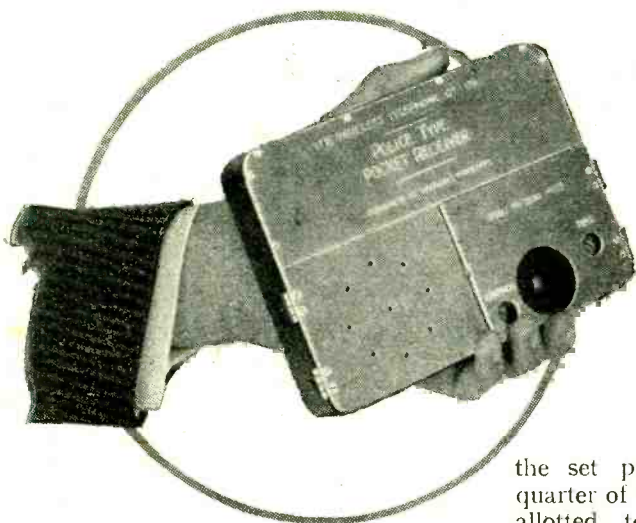

POLICE WIRELESS.

First Description of a Pocket Receiver with a Calling Device.

A GOOD deal of space was recently devoted by the daily Press to descriptions of tests made by the Brighton Police of a new pocket receiver intended to be carried by a policeman on his beat. According to our personal experience, the subject is far too important to be dismissed as being merely another variant of the "smallest wireless set in the world" story, which of recent years has tended to displace the sea serpent as a topic during the silly season.

Early last winter a member of *The Wireless World* technical staff was given a very convincing private demonstration of the apparatus; the time was not then considered opportune for publication of details, but now, thanks to those responsible for its development, we are able to describe and illustrate the complete receiver, which differs little in essentials from the form in which it will finally be standardised.

The real innovation is a calling device; compact pocket sets, with a more or less satisfactory performance, are hardly novelties, although a receiver in which sensitivity, compactness, and lightness are so successfully combined would be hard to find. During the private demonstration already mentioned, the call-bell functioned without a single failure at various distances up to five miles from an experimental transmitter of low power. Much longer ranges are to be anticipated with a station of higher power.

It is not yet possible to disclose full details of the circuit arrangement, but it may be stated that a single valve only is employed. It is connected in a special feed-back circuit, which is the subject of a patent application. Without any exaggeration the set may be described as easily carried in a jacket or tunic pocket. It measures about 6½ in. long, 4¾ in. wide, and 1½ in. thick, and weighs about 1 lb. 14 oz. complete. Actually,

the set proper occupies only about a quarter of this space, the remainder being allotted to the batteries. At present a "Weco" peanut valve is employed; the L.T. current consumption is about ¼ amp., and this current is supplied by a tiny Exide accumulator cell of special construction. A 30-volt Drydex H.T. battery, made up with the smallest standard cells, is called upon to provide an anode current of only about ¼ milliamp., and so it should have a long life.

Robust but Sensitive Relay.

The latest form of collector is a diminutive frame aerial wound around the box, but for our test a flexible frame, built up on a fabric lining, which was pinned inside the back of the coat, was employed.

The relay, probably the most important part of the set, is extraordinarily sensitive, as the change in anode current, due to the carrier wave which operates it, amounts to no more than about ⅓th milliamp. This relay is balanced, and, in spite of its sensitivity, there is a large relative movement of the contacts; it appears to be quite unaffected by vibration or shocks. The earlier type of relay was of the cumulative action type, being operated by a series of timed impulses.

In combination with a single telephone

width. It is intended that this unit shall be carried in one breast pocket and the receiver in the other. The relay is wired in series with the phones, and, of course, is cut out by a switch when listening.

Tuning is done by means of a screw-driver adjustment, and this operation is normally carried out at the police station.

A calling unit, comprising a relay and buzzer. In the latest pattern this apparatus is combined with a telephone receiver in a bakelite case.



The officer on his beat will have no adjustments to worry about.

It needs little imagination to appreciate the possibilities of this set, if only as a weapon to combat the criminal activities of car bandits and "smash-and-grab" raiders.

The apparatus has been designed by Mr. C. L. P. Dean; it is being developed by the Wireless Telephone Co., Ltd., of Cromwell House, Surrey Street, London, W.C.2, of which firm Mr. Dean is a member.

Although the tests to which we have referred were carried out on wavelengths of about 150 metres, it is a matter of some interest that the principle employed in the set may be applied quite successfully on the broadcast band. Indeed, we have had an opportunity of testing a set designed for this purpose, and found it to be surprisingly sensitive.

The experimental broadcast model, also with a single valve and a built-in frame, is of about the same size as the police set, and we hear that it may eventually be produced commercially.

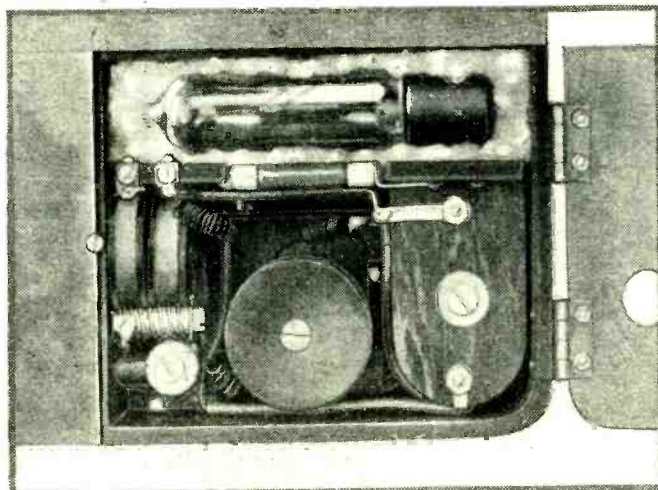

The lower right-hand section of the case, with cover open; this is the complete receiver unit. Referring to the title illustration, the H.T. battery is housed in the top and the L.T. cell in the lower left-hand compartment.

earpiece, the latest type of relay is now built into an annunciator unit, measuring about 6 in. long by 2½ in. in maximum

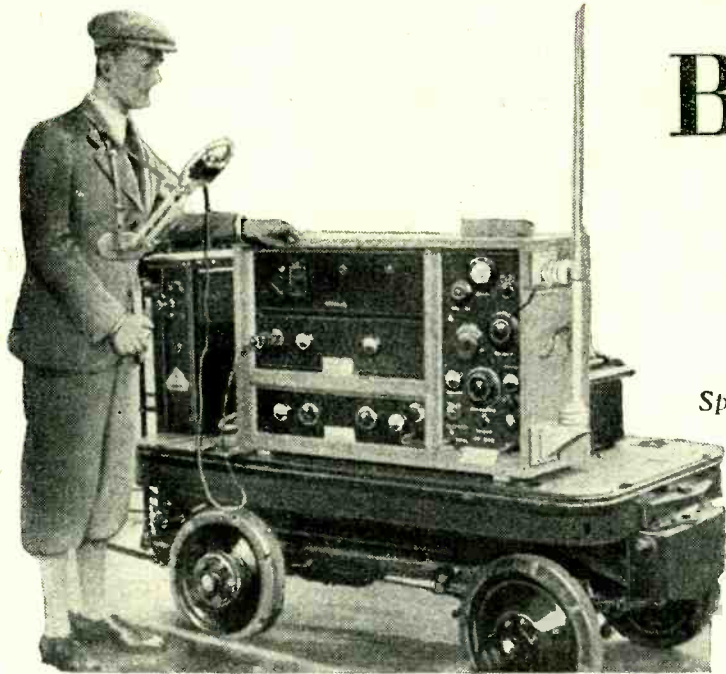

Broadcast Brevities.

By Our
Special Correspondent.

A portable transmitter for outside broadcasts in Germany which attracted considerable attention at the Berlin Show.

Scottish National.

THE preliminary transmissions from Falkirk on 288.3 metres, have proved eminently satisfactory, and the Scottish National station will be working on full service by the end of this month.

Forthcoming Talks.

THE News Bulletins are shortly to be enlivened by regular eye-witness accounts of any special events of the day, and it is also intended to give a vivid presentation of foreign news from abroad by Mr. Vernon Bartlett, who will tour Europe and assume the function of a "wandering microphone." His fortnightly talks will be transmitted direct from various foreign capitals.

An Aid to Agriculture.

IT is easy to make jests about "Fat stock prices" at talks on "Pig Breeding," but the B.B.C. is seriously determined to offer all assistance possible in promoting the interests of farmers, who are undoubtedly feeling the present pinch as much or more than any other class of the community. With this object in view, they have circulated to members of the National Farmers' Union and to the County Agents of the Ministry of Agriculture a number of questions, the answers to which will guide them in arranging further activities on behalf of the industry.

Newcastle's New Wavelength.

FEWER complaints than were expected have been received by the B.B.C. concerning the change of wavelength at the Newcastle Station from 288.5 to 211.3 metres. Novocastrians admit that transmissions on the new wavelength are better than anticipated, and good reception is obtainable on a simple one-valve receiver up to a radius of twelve miles and on a crystal receiver up to at least five miles. There is also a notable improvement in the quality as the B.B.C. took the opportunity to modernise the transmitter when the change was made. Perhaps, also, the fact that over 8,000 copies of their advisory pamphlet were distributed in the neighbourhood incited Northern listeners to overhaul such receivers as had become obsolescent.

Yorkshire's Improved Studio.

WORK on the studio in Leeds is proceeding rapidly, and by the end of October it is expected that everything will be complete, and listeners east of the Pennines will hear more of their own Yorkshire artistes and enjoy better local programmes than at present, when native talent has to journey to Manchester to find adequate accommodation.

Unfinished Debates.

AN interesting feature of the coming season will be the discussions that will form part of the Law Series of Talks. Among the subjects set down for discussion are: "Is Divorce Too Easy?" and "Is the present system of punishment too severe?" The promised political discussions will include such problems as "The Means Test," "Tariff Issues," and "Disarmament."

A Busman's Holiday?

AFTER an unusually strenuous season Mr. Henry Hall and the B.B.C. Dance Orchestra are enjoying a well-earned holiday, and listeners will for a time be regaled with the strains of Ambrose's and other favourite bands. Mr. Hall, however, will not be entirely free from musical cares as, in common with other conductors of dance music, he will be busily engaged in "picking the winners" for the coming season. I am told that the choosing of suitable music from that already published and from a mass of material submitted by composers known and unknown is a grave and serious matter, and this entirely destroys my ignorant illusion that modern dance music is composed and written by the furlong, and then cut off into suitable lengths as required.

The Symphony Concerts.

PROGRAMMES for the coming season of symphony concerts are now complete, and it is evident that the reputation already gained by the B.B.C. Symphony Orchestra is likely to be fully maintained. The principal conductors are, of course, Sir Henry Wood and Dr. Adrian Boult, while Mr. Ernest Ansermet will conduct some of the works of Weber, Mahler, Debussy, Mozart, and Stravinsky on November 16th, and Mr. Arnold Schönberg will take charge of the first concert performance in England of his Variations for Orchestra (Opus 31) which is fixed for February 8th. The three concerts on November 30th and December 7th and 14th are to form an Elgar Celebration and are devoted to his works. The first of these will be conducted by Sir Landon Ronald, and in the second the composer himself will conduct his Symphony No. 2 in E flat.

British Soloists to the Fore.

THE symphony concerts are naturally regarded as the high spots in the year's musical programmes, and the B.B.C. seek to obtain the services of the best artistes irrespective of nationality. It is therefore gratifying to note that among the solo performers more than half are British.

Big Ben in Portland Place.

DWELLERS in the Portland Place district will regret for some reasons the B.B.C.'s decision to relay the chimes of Big Ben from the roof of Broadcasting House. The effect is, of course, striking (no pun intended) but it means the almost complete swamping of the modest little tinkle from the tower of All Souls', Langham Place.

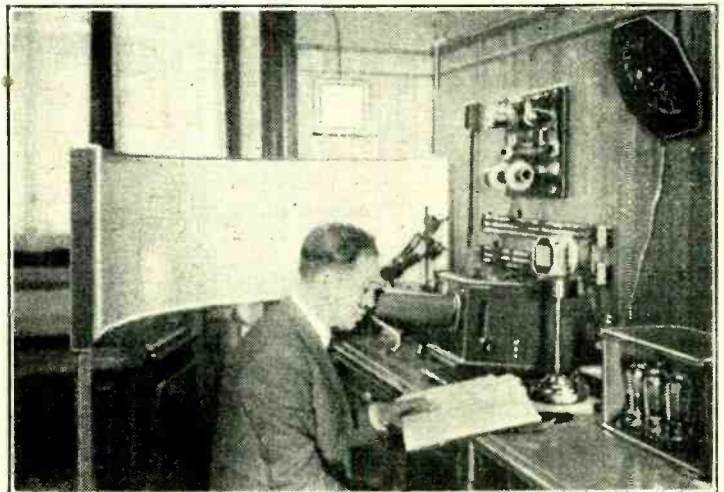

In the Vatican studio. The chief engineer testing the transmitter used for the daily announcements.

The church clock, if it is to make itself heard, must now be wrong. Likewise, the other speaking clocks in the neighbourhood, because Big Ben and the B.B.C. never err.



Remember Screen Current.

WHEN estimating the value of a self-bias resistance for a pentode valve, it must be remembered that the screen current, in addition to that normally passed in the anode circuit, will flow through the bias resistor. By ignoring this, the value of bias resistor arrived at by calculation is greater than it should be, and we think that a querist, who asks us to check the circuit diagram of proposed alterations to his output stage, has forgotten to add screen current to anode current.

The screen current of the average pentode valve amounts to very roughly one-fifth of its anode current.

Power Transformer Consideration.

FOR most practical purposes, it can be considered that the R.M.S. current flowing in each section of a centre-tapped H.T. transformer secondary is equal to one-half of the D.C. output current. This relates to power transformers supplying current to full-wave rectifying valves: a correspondent, who has one of these components, rated by its maker for currents in the H.T. winding up to 100 milliamps., can rest assured that it should be suitable for use with a full-wave rectifying valve rated to give a D.C. output of 120 milliamps.

Output 2½ Times Greater.

THERE is still uncertainty as to the increase in undistorted output that is brought about by the use of a push-pull output stage; one reader, who is proposing to fit push-pull valves of the same type as at present used in his single-valve output stage, apparently thinks that undistorted volume will be increased to quite a small extent, but that gains in other directions will compensate him for the extra expense.

Actually, it is generally agreed that as a result of making this change, the output will be increased to about 2½ times that obtainable from a single valve of the same type. An even greater increase of output than this has been claimed, but to obtain it, an exceptionally accurate balance would be required.

In making this statement, it is assumed, of course, that the same voltages will be applied in each case. If, as a result of adding a valve to our reader's set, the output of his eliminator is reduced excessively, the gain in undistorted volume will be nothing like that suggested.

Roundabout Measurements.

IT is asked whether there is a reasonably accurate method of measuring the A.C. voltage existing across a valve heater without the use of a proper A.C. meter. Our reader goes on to say that he seems to remember having seen some information on this subject in a back number of *The Wireless World*.

With the help of an ordinary D.C. voltmeter, a milliammeter, an L.T. accumulator (preferably of 6 volts, but two fully charged cells will do), and a rheostat, it is possible, with care, to make an accurate measurement by indirect means.

The procedure is first to take a reading of the anode current of the valve concerned under normal operating conditions with A.C. heating. Next, disconnect the L.T. transformer second-

ary from the heater terminals, and then shunt across these terminals the D.C. voltmeter and also the L.T. accumulator, in series with a rheostat of 3 or 4 ohms.

A measurement is effected by varying the rheostat setting until anode current is restored to its original value with unchanged operating conditions, except for those specified in the heater circuit. When this state of affairs has been attained, the D.C. voltage shown by the heater voltmeter will correspond exactly to the R.M.S. voltage originally derived from the power transformer.

Although this may seem rather involved, we do not think there is any simpler way, in the absence of an A.C. meter, of checking the low-tension A.C. voltage applied to the heater terminals of a valve.

Obsolete Practice.

WITH a request for criticism, a reader sends us the circuit diagram of a proposed det.-L.F. set for D.C. mains feed. The heater and cathode circuits are to be arranged as in Fig. 1 (a).

Although arrangements on comparable lines were at one time popular, the method of obtaining bias which is shown by our reader can no longer be considered as representing good practice. Referring to his circuit, it is intended that negative voltage for the output valve grid shall be derived from the combined drop in voltage across the detector valve heater and the resistance "R." By making a suitable choice of resistance, it is certain that the

THESE columns are reserved for the publication of matter of general interest arising out of problems submitted by our readers.

Readers requiring an individual reply to their technical questions by post are referred to "The Wireless World" Information Bureau, of which full particulars, with the fee charged, are to be found on page 261.

lead of the valve concerned. This point is illustrated diagrammatically in Fig. 1 (b), which represents the arrangement that is generally advocated nowadays.

Extending Wave Range.

A CORRESPONDENT has a two-year-old commercial receiver with a ganged tuning system, which, he states, cannot be tuned to a lower wavelength than about 220 metres. It is desired to extend the wave range in a downward direction to the extent of 10 metres or so, preferably without having to go to the trouble of removing turns from the tuning coils.

It sometimes happens that, when making initial "ganging" adjustments, all the trimmers in a receiver are set at an unnecessarily high value, with the result that the minimum wavelength receivable is unduly high. Accordingly, an attempt should be made in this case to see whether it is not possible to retrim with lower capacity settings all round.

Again, there is the possibility that the aerial is connected in such a way to the input coil that an unduly high proportion of its capacity

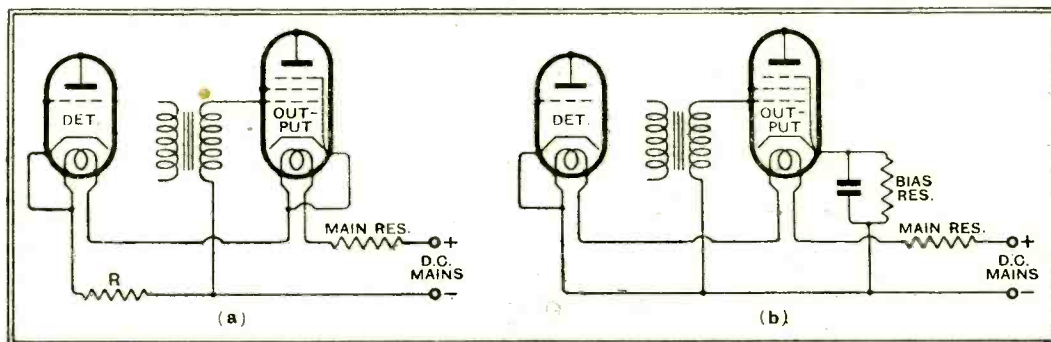

Fig. 1.—In D.C. mains receivers, grid bias voltage can be derived either from heater current or anode current. The second method (diagram b) is generally preferable.

desired voltage could be obtained, but it will be derived from the mains supply, and so is likely to have a superimposed "ripple," which will give rise to hum unless precautions are taken.

When modern indirectly heated D.C. valves are employed, it is not usual to smooth the heater supply, but, of course, the anode current must invariably be smoothed, whatever system of bias be employed. Therefore, it is clearly much better to derive bias voltage from this smoothed supply, and one usually does so by inserting a suitable resistance in the cathode

is transferred to the tuned input circuit. The desired results might just possibly be achieved by inserting a small condenser between the aerial and its terminal, and again retrimming.

But this expedient will be successful only if it happens that the trimming capacities of the various circuits are determined by the incidental capacity across the input. If—and it is more probable—one of the other circuits happens to have the higher stray capacity, it is unlikely that it will be practicable to bring about a considerable improvement, and we fear that our querist may find it essential to remove turns.

The Wireless World

A
PRACTICAL RADIO
JOURNAL
22nd Year of Publication

No. 681.

FRIDAY, SEPTEMBER 16TH, 1932.

VOL. XXXI. No. 11.

Editor:

HUGH S. POCKOCK.

Proprietors: ILIFFE & SONS LTD.

Editorial Offices:

116-117, FLEET STREET, LONDON, E.C.4.

Editorial Telephone: City 9472 (5 lines).

Advertising and Publishing Offices:

DORSET HOUSE, TUDOR STREET,

LONDON, E.C.4.

Telephone: City 2846 (15 lines).

Telegrams: "Ethaworld, Fleet, London."

COVENTRY: Hertford Street.

Telegrams: "Cyclist, Coventry." Telephone: 5210 Coventry.

BIRMINGHAM:

Guildhall Buildings, Navigation Street, 2.

Telegrams: "Autopress, Birmingham." Telephone: 2970 Midland (3 lines).

MANCHESTER: 260, Deansgate.

Telegrams: "Iliffe, Manchester." Telephone: Blackfriars 4412 (4 lines).

GLASGOW: 26B, Renfield Street, C.2.

Telegrams: "Iliffe, Glasgow." Telephone: Central 4857.

PUBLISHED WEEKLY. ENTERED AS SECOND CLASS MATTER AT NEW YORK, N.Y.

Subscription Rates:

Home, £1 1s. 8d.; Canada, £1 1s. 8d.; other countries abroad, £1 3s. 10d. per annum.

As many of the circuits and apparatus described in these pages are covered by patents, readers are advised, before making use of them, to satisfy themselves that they would not be infringing patents.

CONTENTS.

Editorial Comment	271
New Development in Tuning Coils	272
A Balanced Wave Trap	274
Practical Hints and Tips	275
A New Patents Act	276
News of the Week	277
Unbiased	278
PROGRAMMES FROM ABROAD, pp. 1-XX1	
Broadcast Brevities	279
Berlin Radio Show	280
Correspondence	284
Trix 50-watt Power Amplifier ..	285
Laboratory Tests	287
Readers' Problems	288

EDITORIAL COMMENT.

Static Interference.

Is Legislation the Remedy?

AN American visitor to Europe, who came to study the Broadcasting position, returned home recently with a very poor impression of conditions in this continent. Chief amongst the unfavourable impressions he gathered was the lack of any concerted action to overcome those types of interference with reception which are caused by various forms of electrical apparatus.

In this country we are proverbially slow to take effective measures to remedy abuses or practices which lead to public inconvenience until they have reached such a stage that they can no longer be tolerated. In the case of road traffic, despite the destruction of the highways, the vibration caused to buildings and general discomfort to the public, it is only quite recently that even a half-hearted attempt has been made to reduce the percentage of unsuitably "shod" heavy vehicles making general use of the public highways.

The ether to-day should be regarded as, in every sense, a public highway, and those who use it should only be permitted to do so provided that they give adequate consideration to the comfort and convenience of others.

Legislation, it would seem, is the only effective remedy, since efforts at control by other means can only be expected to have a very limited effect. It would, perhaps, be unreasonable to expect an immediate remedy to be found for every existing type of electrical interference, but it would surely be fair to introduce legislation which would remedy the trouble gradually.

It should be made illegal to sell or install apparatus causing interference, after a certain date to be decided upon,

and a second date could be arrived at on a reasonable basis after which all existing electrical apparatus had to be made free from interference or be dismantled.

Sooner or later we shall be obliged to take some such action—why not now, at a time when so much new electrical apparatus is being installed which could be made free from interference at little cost?

The New Tuning Coils.

Results of Preliminary Tests.

TO the eye accustomed to the proportions of normal air-cored inductances, the claims made for the coils illustrated in the article on page 272 of this issue must indeed appear fantastic. Yet there can be no doubt of the validity of these claims. Tests made in *The Wireless World* laboratory on advance specimens show a decrease of H.F. resistance of the order of 15 per cent. by comparison with an air-cored and space-wound laboratory coil 3 ins. in diameter.

The secret of the efficiency of the new coils is to be found in the small number of turns required for a given inductance. Thus although the ratio of H.F. to D.C. resistance is greater, the total copper losses are much less than in an air-cored coil of equivalent inductance. The self-capacity of the new coils would appear to be somewhat on the high side and is of the order of 25 micro-mfd. in a 150 microhenry coil. Any difficulties which may arise on this score, however, are not insuperable, and if accurate matching of inductance can be achieved in production by adjusting the thickness of the core we predict that the new coils will exercise an important influence on receiver design in the future.

NEW DEVELOPMENT IN TUNING COILS.

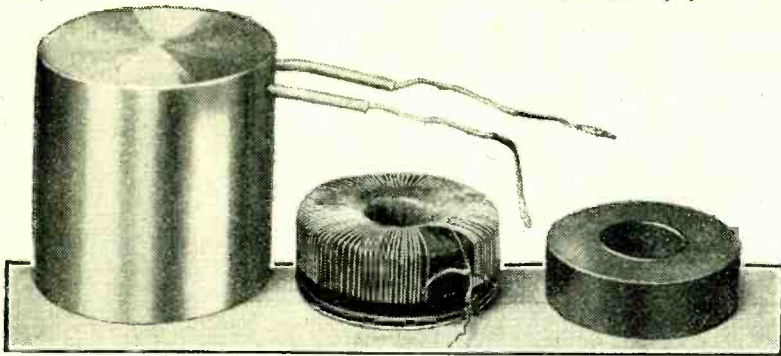

Ferrocart coils, the larger of which measures only 2ins. x 2ins.

By HANS VOGT.

Inductances of Remarkably High Efficiency Using "Ferrocart" Cores.

UNTIL recently the demand for higher selectivity has been met chiefly by increasing the number of tuned circuits in the receiver, a process which almost inevitably tends to reduce the efficiency. It is well known, however, that greater selectivity may be obtained with increased efficiency merely by reducing the resistance of the tuned circuits. Hitherto it has proved impracticable to reduce the resistance below the present average figure whilst adhering to moderate overall dimensions; therefore,

are considerable leakage fields which may cause undesirable couplings, unless close screening, which vitiates the "goodness" of the coil, is employed.

CONSIDERABLE interest attaches to the first description in this country of a new type of tuning inductance representing a radical departure from orthodox practice. By the use of a solid core containing finely divided high-permeability metal, it has been found possible to construct miniature coils rivalling in efficiency those of the air-core type on zin. formers. Further reference will be found elsewhere in this issue to these coils, which it is anticipated will soon be obtainable from various sources in this country.

small coils having an extraordinarily low high-frequency loss. The material is used as a solid core around which the coils are wound toroidally. It should thus be possible in future to construct wireless receivers having smaller dimensions and yet increased selectivity.

The new metal, Ferrocart, consists of minute particles of a high-grade magnetic material so separated by means of a special insulation process that eddy current losses are reduced to a minimum. In fact, at high frequencies in the order of 1,000 kilo-

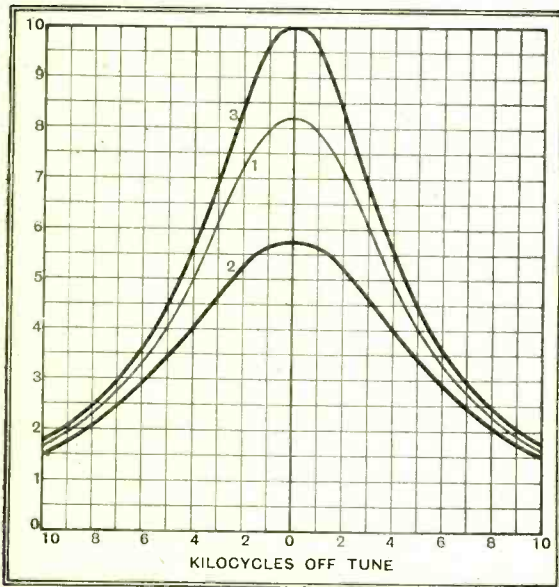

Fig. 1.—Resonance curves at 300 metres of the coils shown in Fig. 2. It will be seen that curve 3 for the Ferrocart coil (screened or unscreened) is considerably steeper than the others.

The designer has had perforce to seek a compromise and use the largest screened coil possible within the space limitations of his receiver. It is believed that such a compromise need no longer exist in future, for the author has succeeded in producing in his laboratory a new material called "Ferrocart," which renders possible the construction of extremely

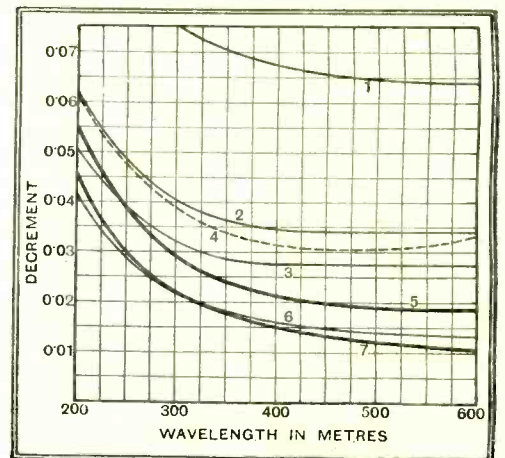

Fig. 3.—The damping decrements of the coils of Fig. 4. The inductance in each case is 200 microhenrys.

considerable importance attaches to the development of a new type of coil having diminutive proportions and exceedingly low losses.

When a tuning circuit of exceptionally low high-frequency resistance is required, a stranded conductor wound on a comparatively large cylindrical former is usually pressed into service. Unfortunately, such a coil is expensive, and when it comes to the use of a number in a multi-valve receiver the cost is prohibitive. Furthermore, owing to the size of the coils, there

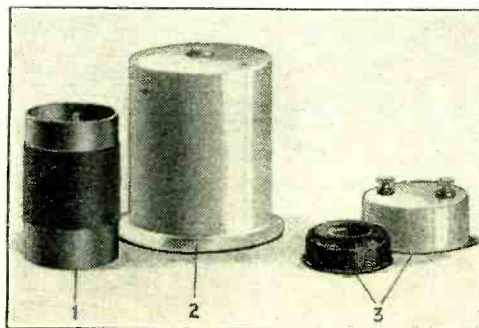

Fig. 2.—Ferrocart coils, screened and un-screened (on the right), compared in size with ordinary screened and un-screened air-cored solenoids (on the left). All the coils shown in this illustration are of 200 microhenrys inductance.

cycles, the magnetic losses are less than the high-frequency losses occurring in copper. The new material possesses a greater magnetic conductivity than air, and so, when compared with an air-cored coil, the copper employed can be decreased, and therefore the copper loss considerably reduced. The coils are so shaped that leakage fields are reduced to a minimum.

Ferrocart is made in different shapes, and is quite easy to work, for it can be stamped out or sawn, and individual parts can be pressed together by the application of heat.

In Fig. 2 the new coils are shown alongside an ordinary air-cored cylindrical inductance. It will be seen that the Ferrocart coil is considerably smaller than the

New Development in Tuning Coils.—

cylindrical type, although the inductance in each case is 200 microhenrys. Another advantage of the new coils is that the screen can be arranged extremely close to the winding without changing the constants.

The resonance curves at 200 metres for these coils are given in Fig. 1. Curve 1 is for the cylindrical coil, while curve 2 is for the same coil screened. The effect of the screen in flattening the curve is immediately seen; this, of course, means that the selectivity is decreased. The damping decrement¹ increases from 0.032 to 0.038. Curve 3, which corresponds to the small Ferrocart coil, is steeper than that of the cylindrical coil, and the decrement is smaller.

Perhaps the most significant fact is that the close screening of the Ferrocart coil does not sensibly alter the damping, although the distance between the coil and the screen is only a few millimetres.

In Fig. 4 a large number of coils of different shapes are illustrated, all having the same inductance, namely, 200 microhenrys. The damping decrement of these coils is given in Fig. 3, from which the superiority of coil No. 7 is evident. It is interesting to note that coil No. 6 is an ambitious air-core Litz inductance with 68 turns, which it is almost impossible to screen unless enormous metal containers are used. When the Ferrocart coil No. 7 is compared with this coil, it is seen to occupy only about one-third of the space,

¹ Decrement $\delta = \frac{R}{2fL}$ where R is the high-frequency resistance, f the frequency and L the inductance.

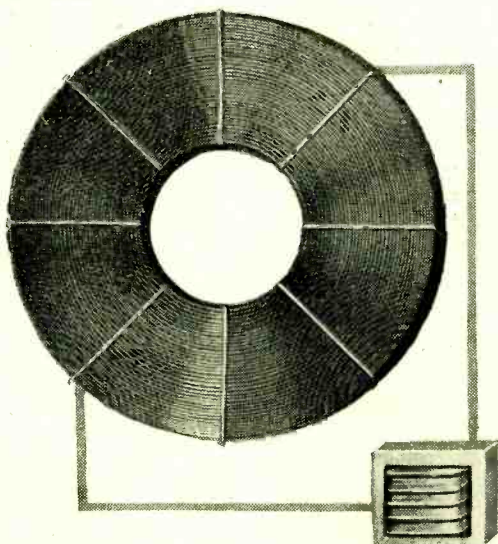

Fig. 5.—To obtain two coils of 7.7 millihenrys inductance and of equal decrement using air and Ferrocart cores respectively, they must be constructed to the above relative sizes.

and has rather a smaller decrement.

Nearly all coils which are to-day employed in wireless sets lie between curves 1 and 4. The smallest Ferrocart coil, very closely screened, has a decrement (see

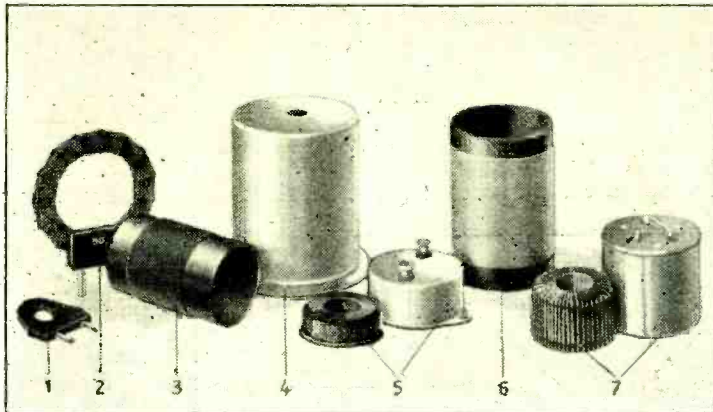

Fig. 4.—A further comparison between air-cored and the new solid-cored coils. Coils 5 and 7 are toroidally wound Ferrocart coils shown screened and unscreened.

curve 5) of two-thirds that of the others over most of the wave range.

The new coils are toroidally wound, and are only influenced to a very small degree by external magnetic fields, but, in order to avoid electrostatic coupling, it is advisable always to employ a screen.

The use of Ferrocart coils is not confined to single tuned circuits, for it is possible to design high-frequency transformers, band-pass filters, choke coils, etc., in which can be combined the properties of compactness and efficiency.

THE WIRELESS ECLIPSE.

**Corpuscular Ionisation
"Not Proven"?**

SO far as radio is concerned, the eclipse of August 31st has only proved a partial success. It has certainly established what was not really in doubt—that the cutting-off of the sun's emanations had an effect on the propagation of wireless signals. But apparently it has not been as fruitful as it might have been in providing data to permit the determination of the nature of the solar agencies which are responsible for the two recognised ionised regions.

Our issue of August 19th outlined the theory that, while the upper or Appleton layer—the F layer—was agreed to be due to the actinic effect of the sun's rays, the lower or Heaviside layer—the E layer—might be due to corpuscles or particles shot off from the sun. It was also shown that if these particles actually had the estimated limiting velocity of 1,000 miles per second the eclipsing effect on the corpuscular supply would be experienced earlier in time and eastwards on the earth to the region of optical totality.

Naturally, it is yet rather early to draw definite conclusions, but preliminary results which are available apparently place the corpuscular theory in the category best summed up by the Scottish verdict of "not proven."

This is not, of course, wholly surpris-

ing, as the main part of the calculated corpuscular eclipse lay over the Atlantic Ocean. England lay rather close on the edge, and the remainder of Western Europe was too near sunset and the unsettled conditions which are known to characterise that period.

In England, observations were made at London, Cambridge, and Slough on special local transmissions of the short-pulse type. In this method a very short signal impulse is sent out, and the ground-ray signal is received and recorded before any of its subsequent "echoes" arrive. The time-interval between the ground-ray and any echo then permits determination of the height from which that echo has been returned, along with other details of its path from transmitter to receiver. Additionally, observations were made on transatlantic transmissions both on short and long waves. Check observations were also made before and after.

Inconclusive Observations.

In the case of the London observations there was a slight suggestion of a "particle-eclipse" effect, but apparently by particles of slower velocity than had been calculated. The same effect, however, was observed during the succeeding evening, and is thus rather against a corpuscular effect on the night of the eclipse. These combined observations of these British stations show that there was certainly a low density of ionisation at the time appropriate to the corpuscular eclipse, followed by a definite increase. Even this, however, is not very conclusive. Although the drop at 18.30 G.M.T.—the time of calculated maximum for the corpuscular eclipse—was not reproduced on check days, the increase of ionisation between 18.30 and 19.00 was also met on the day prior to the eclipse.

The evidence from these experiments is thus very inconclusive as to the manifestation of any effect that could definitely be correlated with the corpuscular eclipse, particularly in its effect on the E layer.

In the case of the short-wave observations on transatlantic transmissions, the general behaviour of the channels was such as to permit no valid interpretation of eclipse effects. The long-wave channel showed a very marked drop of signal strength between 20.15 and 20.18 on the 31st. This time was fairly close to that of optical eclipse at the American end of the channel. The dip was peculiar to the eclipse day and time, and was not recorded on check days. It is very significant that, at this frequency, the E layer is the important factor, and that therefore this layer was strongly influenced by the optical eclipse. This would, therefore, appear to rule out corpuscular action as, at least, the main ionising agent of the lower region.

The existing evidence, although negative in its bearing on any corpuscular ionisation in the Heaviside layer, is quite definite in showing that this layer, as well as the Appleton layer, is strongly influenced by ultra-violet radiation.

A BALANCED WAVE TRAP.

Eliminating Local Station Interference by a New Method.

By W. S. PERCIVAL, B.Sc., A.M.I.E.E.
(Research Department, Kolster-Brandes.)

THE use of a rejector circuit in the aerial lead of a receiver as shown in Fig. 1 is well known as a means of eliminating an undesired signal of the frequency to which the rejector circuit is tuned. The effectiveness of such a wave trap depends on both the inductance and magnification of the coil. The larger the inductance and the higher the magnification of the coil the greater is the reduction in the amplitude of the undesired signal.

However, it is not sufficient simply to eliminate the undesired transmission; it is also necessary to receive a neighbouring transmission with as little reduction in signal strength as possible. In other words, the criterion for a wave trap is its ability to discriminate between the desired and the undesired signals. It can be shown that for the greatest discrimination between two given transmissions the magnification of the coil should be a maximum, and its inductance should have a certain optimum value.

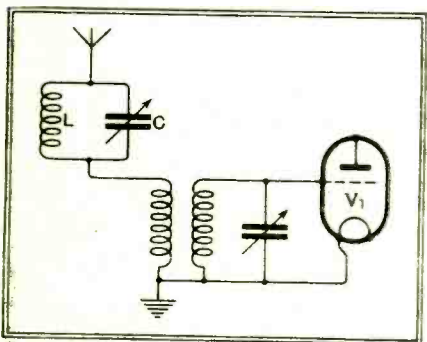

Fig. 1.—A simple wave trap of this type, in addition to eliminating the local station, generally reduces the strength of adjacent transmissions.

In some experiments with a simple wave trap the writer found it impossible to obtain a sufficiently high degree of discrimination with practicable coil magnifications, however carefully the inductance was chosen. If the required station was to be received at the necessary strength the interfering transmission came in as well. An attempt was therefore made to balance out the signal which it was desired to eliminate.

Simplest Circuit the Best.

A large number of bridge circuits were tried out and many complications introduced. Ultimately the simplest circuit was found to be the best, and this is shown in Fig. 2. It will be seen that the current from the aerial to the earth splits into two parts, one passing through the rejector circuit LC and the upper half of the aerial transformer primary, and the other through the variable resistance R and the lower half of the same primary.

Now it is well known that at resonance the circuit LC behaves as a pure resistance. Thus, if R is adjusted to the same value as this resistance, equal and opposite currents will flow in the two portions of the transformer primary. If the two portions are

equal, then no voltage will be induced in the secondary. In other words, the undesired signal will be completely balanced out.

For practical purposes a slight modifica-

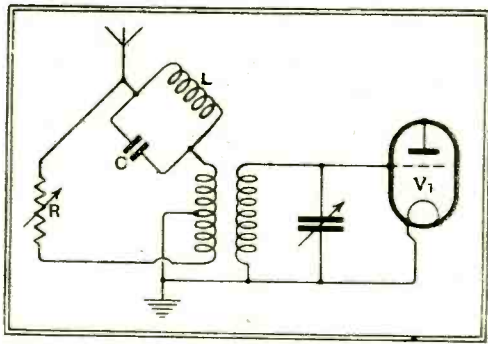

Fig. 2.—The balanced wave trap in its simplest form. The value of R is adjusted to equal the impedance of L.C. at resonance.

tion was introduced by connecting the aerial to a tap on the coil as shown in Fig. 3. In this way the effective inductance of the coil in the aerial lead could be adjusted by simply changing the aerial tapping point. The resistance employed was a 100,000-ohm track type with an approximately logarithmic law. With this form of wave trap it was found possible to reduce the signal strength of the local station 15 miles away to a whisper. The receiver was of the superheterodyne type and was tuned to the same station.

A curious feature was the intolerable distortion on the weak signal remaining. Frequency distortion might have been expected, but this was clearly amplitude distortion as well and resembled that due to serious overloading of the low-frequency amplifier. It was presumably a result of over-modulation caused by the suppression of the carrier to a greater extent than the side bands.

In the first experiment a direct drive was employed for the condenser C. It was soon discovered, however, that not only was a vernier drive essential, but that an extension handle had also to be fitted to eliminate hand capacity if an accurate balance was to be

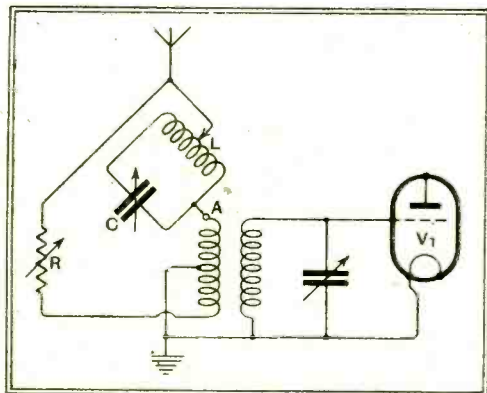

Fig. 3.—The effective inductance in the aerial lead may be adjusted by introducing a series of tappings on the inductance L.

obtained. In fact, the more accurately R was adjusted the sharper became the tuning of C. Finally, a change in capacity of one part in a thousand was sufficient to bring the local station up from a whisper to full strength.

A somewhat unexpected virtue of the wave trap described is its ability to balance out direct pick-up on the coils as well as that due to the aerial-earth system. This was first discovered by removing the aerial, when the signal strength increased several times. A short additional aerial was therefore connected directly to the aerial terminal A of the set to simulate coil pick-up, and the bridge readjusted until the station was again eliminated. In this condition the bridge is not, of course, balanced, but serves to provide an e.m.f. equal in magnitude, but opposite in phase, to that derived from the extra aerial.

Low Primary Inductance.

It is easy to see that the balanced wave trap not only serves to eliminate an undesired signal completely, but also provides a greater degree of discrimination between the desired and the undesired station. Thus in the ordinary rejector circuit the coil L must not be reduced below a certain inductance, or the undesired station will come through. In the modified form, however, L can be reduced to a much lower value while still

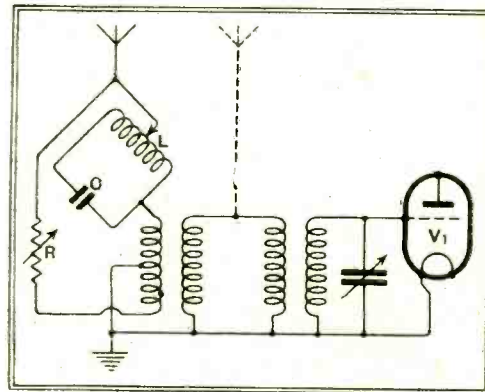

Fig. 4.—Where it is inconvenient to make modifications to the existing aerial circuit, an external input transformer may be used to couple the wave trap to the aerial and earth terminals.

eliminating the undesired station. The impedance presented to the signal required is consequently much less. A limit is, however, reached when the resistance R is low enough seriously to damp the aerial circuit. For this reason the primary aerial inductance should be kept as low as possible.

A disadvantage of the circuit not dealt with so far is the impossibility of adding it to an existing set without modifying the aerial transformer. This drawback can be obviated, at the expense of a certain amount of signal strength, by the use of an additional transformer as shown in Fig. 4

Practical HINTS AND TIPS.

AIDS TO BETTER RECEPTION.

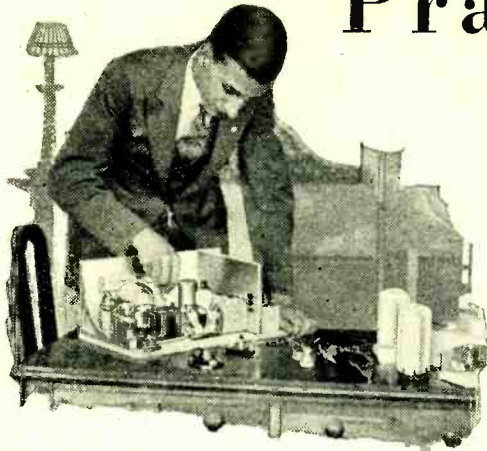

THE suggestion is often made in the pages of this journal that some form of measuring instrument—even if it be nothing more elaborate than a detector anode milliammeter—should be employed when making initial adjustments to a new receiver, and particularly when carrying out the operation of setting the trimming condensers which are included in all receivers with ganged tuning.

Aural and Visual Indications.

It would be foolish to attempt to belittle the soundness of this advice, for it is a demonstrable fact that, however carefully adjustments may be made with the ear as a guide, results can nearly always be improved upon with the help of a more certain and definite indication. But it is also a fact that too great a reliance upon the meter can be dangerous, as all sorts of puzzling effects may arise if the old-fashioned "listening test" be ignored entirely.

For instance, meter deflections may actually be due to self-oscillation of one or more valves of the receiver, or perhaps to a carrier wave instead of a local oscillator, to the emanations of which it is imagined that the receiver is being tuned.

Unless one has a great deal of experience of instrument work, it is perhaps best to make rough initial adjustments by aural means, and then, with the meter as a guide, to give the final touches which make all the difference to the ultimate success of a modern set.

IT would seem that those who have low-voltage house-lighting systems do not make as much use as they might of the new indirectly heated D.C. valves. It should be remembered that these valves are much more efficient than the battery

Low-voltage D.C. Supplies.

types which are the only other practical alternative; although a pressure of 50 volts, which is a common voltage for domestic use, is clearly inadequate for H.T. supply, it is sufficient for the heater circuits of, say, a three-valve set, while for the anode circuits the supply voltage may be supplemented by H.T. accumulators. These cells, if suitably arranged in groups, may be charged

from the lighting system, each group being given attention in turn.

A skeleton diagram, showing the essentials of an arrangement that has proved itself to be practicable, is given in Fig. 1. Three 16-volt valves are connected in series, and so a very low value of absorbing resistance is needed; actually, the limiting resistance of 8 ohms shown in the diagram might be omitted.

A part of the high-tension voltage needed to operate the set is derived from the mains, but as a pressure of 50 volts is, of course, totally inadequate, this is supplemented by four 30-volt groups (marked A, B, C, D) of H.T. accumulators. Connections from each group are led to a distribution board, which is fitted with sockets, both in order that the groups may be isolated for charging purposes, and that a charging plug, connected in series with the limiting resistance R across the mains, may be joined to any one of the groups at will.

The arrangement described provides for a total H.T. pressure of about 170 volts—120 volts from the H.T. accumulators, and 50 volts from the lighting system. This is rather on the low side, but at any rate provides better results than could be expected from battery valves, and there is, of course, no reason why voltage should not be increased up to the maximum at

inserted at the point X, with, of course, the usual reservoir condenser.

MULTIPLE-UNIT ganged condensers may fairly be called instruments of precision nowadays; if they were not, the good results so widely attained with sets having single-knob tuning would be quite out of the question. But, although the

Checking Ganged Condensers.

rigidity of these components has been greatly improved of late, a warning as to the need for taking reasonable care in handling them will not be out of place. Indeed, one can justly say that no part of a set—not excepting the valves—should be handled with more respect. The matching of individual units of even the best of condensers is likely to be impaired if they are dropped on the floor, and much less harsh treatment may well have a prejudicial effect on the accuracy of the average specimen.

Apart from the question of accidents, there is a possibility that the whole frame may be distorted when the condenser is mounted in position if unequal pressure be

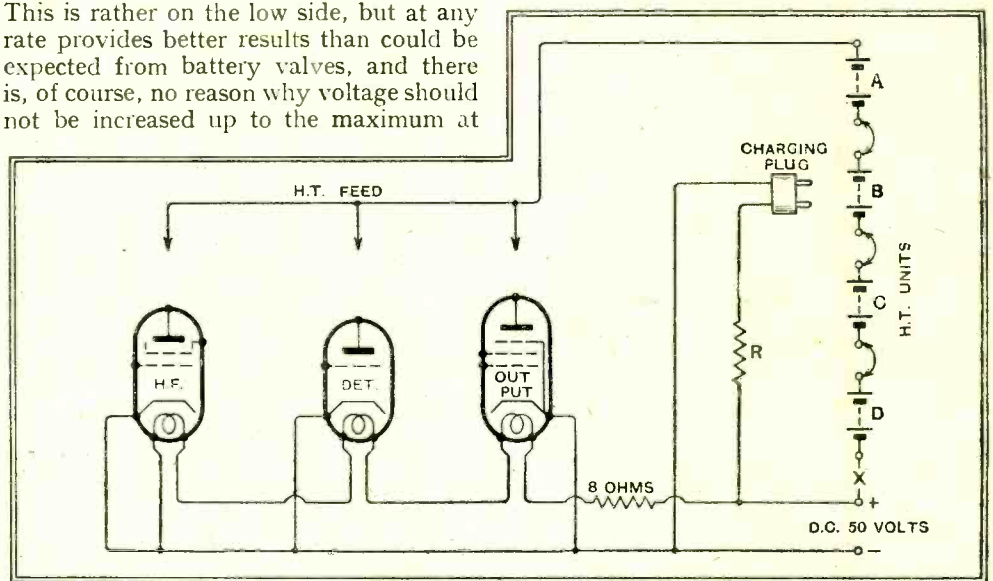

Fig. 1.—A suggestion for feeding modern indirectly heated D.C. valves from a low-voltage house-lighting system.

which the valves are rated by fitting an extra H.T. battery group, or by adding slightly to the number of cells in each group. It should be realised, however, that the voltage of each group must be considerably under that of the supply, or else it will be impossible to charge the cells properly.

More often than not, smoothing is quite unnecessary, but if it is desired to operate the set while the house-lighting cells are being charged, a smoothing choke may be

exerted by the holding-down screws. Consequently, great care should be taken to see that the condenser is mounted on a flat surface, or else strains may be avoided by the use of packing washers of suitable thickness. An alternative, and perhaps better, plan is to avoid rigid mounting altogether by interposing bushes of resilient material; this practice is exemplified in some of the latest superheterodynes, although flexible mounting is here adopted mainly for another reason.

An unmatched condenser will seldom give any visible indication that anything is wrong, and in order to determine whether poor results are really due to defects in this component—and not to the coils—it is usually quickest in the long run to remove the condenser from the set and to apply an electrical test. Unfortunately, a certain amount of apparatus will be needed, but this is of the type which is usually available, or, at any rate, which can be improvised, with existing components. The absorption method, which has so many applications, and which, incidentally, is a veritable godsend to the amateur, again comes to our help, and it is suggested that the method of testing illustrated diagrammatically in Fig. 2 will generally prove to be the simplest.

Referring to this circuit diagram, the valve oscillator that is necessary for testing may consist of the circuits of any reacting detector valve, with a milliammeter added in series with the anode. In place of the normal tuning condenser, the ganged condenser under suspicion is shunted across the tuning coil, arrangements being made by means of a plug-

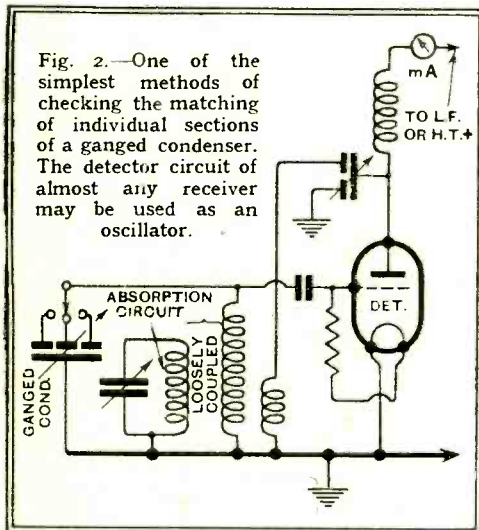

Fig. 2.—One of the simplest methods of checking the matching of individual sections of a ganged condenser. The detector circuit of almost any receiver may be used as an oscillator.

and-socket connection or a spring clip to join any section of this condenser in circuit. Initial adjustments are made by setting the moving vanes to minimum capacity, and then adjusting individual trimmers so that the grid circuit resonates to precisely the same wavelength when tuned by any one unit. Resonance is most easily determined by the use of an absorption circuit (as shown), of which the coupling to the grid coil should be just close enough to give a slight deflection of the milliammeter needle as the indicating circuit is tuned through resonance.

Having set the trimming condensers, check readings should be taken at as many points as possible of the ganged condenser; for each setting, the reading of the absorption circuit condenser corresponding to resonance should be exactly the same, whichever unit of the ganged condenser may be in circuit.

If considerable discrepancies should be found, there is usually no course open to the amateur but to arrange with the manufacturers to realign the condenser; this is distinctly a job for specialists.

A New Patents Act.

Inventors and the Public.

By OUR LEGAL CORRESPONDENT.

ONE cannot go very far on the technical side of wireless without coming into contact with patent rights, for they permeate the whole industry. Whether this is for good or ill is perhaps debatable. But it is certain that we must either invent or stagnate, and the system of granting Letters Patent—though not perfect—is at least a conscientious attempt to encourage and protect the inventor.

Even at the present time wireless offers more promising opportunities to a worker gifted with inventive faculty than is probably to be found in any other field of applied science, so that there are good grounds for calling the attention of our readers to certain important alterations in patent law and procedure introduced by the new Act of Parliament which comes into force on November 1st next.

Perhaps the most far-reaching change is that which relates to the search made by the Patent Office into the novelty of every application as it is filed.

It will, of course, be appreciated that novelty is the essential ingredient of any invention. In law no valid patent can be granted to an inventor unless his application does, in fact, disclose something which has not previously been used or described elsewhere. Up to the present, the official test has been limited to a comparison of the application as filed with all previous British patents over a period of fifty years.

Such a search does not, of course, cover the whole of the area in which a previous publication may have been made. It may therefore happen that an inventor secures his grant from the Patent Office, and then goes into court to sue for infringement. Here he finds himself open to attack from all directions, and is possibly confronted with an "anticipation" in an earlier American patent or in some technical paper or periodical of which he was previously unaware. In this case the inventor is unlucky, for the Court will hold his patent worthless.

World-wide Investigation.

The new Act seeks to reduce this danger by extending the area of the official search so as to cover Foreign, as well as British Patent Specifications, together with all relevant scientific text books and technical publications. In other words, it is designed to make the British investigation world-wide or universal, as is at present the case in Germany and the U.S.A.

The task is, of course, so enormous that it can only be brought into full operation by degrees. Arrangements are already being made to collect and arrange new search material in order to make a start in November next. As time goes on fresh material will be added, until the grant of a British patent should become generally recognised as a hall-mark of novelty.

To meet the extra cost involved the Act increases the stamp fee payable on filing a Complete Specification from £3 to £4. The cost of filing a Provisional remains at £1, whilst the £1 fee payable on sealing is also left unaltered. The net effect, therefore, is to raise the total stamp fees from £5 to £6.

Since the extended search will naturally make greater demands on the time of the

official staff, the new Act increases the normal period allowed between filing an application and the grant of formal Letters Patent. For instance, a Complete Specification may now be lodged twelve months after filing the Provisional, instead of nine months; the time for acceptance is increased to eighteen as compared with fifteen months; whilst the Sealed Patent may be issued at any time up to twenty-one months after making the initial application. Certain extensions, limited at most to three months, may, however, be secured over and above these dates by paying prescribed fees.

The provisions set out above chiefly concern the individual inventor when applying for the grant of a patent. The new Act, however, also introduces certain features which govern the relation of the patentee to the public in general.

Revoking a Patent.

For instance, an existing patent may be revoked on various grounds, amongst which the following are specially mentioned:—

That the invention is not useful.

That the Complete Specification does not sufficiently and clearly ascertain the scope of the monopoly claimed.

That the Complete Specification does not disclose the best method of carrying out the invention known to the inventor at the time when he filed his application at the Patent Office.

That the invention is obvious, and does not involve any inventive step, having regard to what was known or used prior to the date of the patent.

In addition, specific power is given to the Comptroller of the Patent Office to refuse to grant a patent where the invention—

(a) has been wholly described in a prior publication, or

(b) is so obviously contrary to well-established natural laws as to be frivolous.

Other important provisions:—

(a) allow an applicant to convert a Complete into a Provisional Specification,

(b) allow an application to be voluntarily post-dated (before acceptance) by any period up to six months.

A common abuse—indulged in by some patentees—is to issue groundless threats of legal proceedings to alleged infringers. In this connection the new Act lays down that if any person threatens to bring an infringement action against another, then whether the person who makes the threat is or is not entitled to the patent-rights in question, the person threatened may apply to the Court to obtain a declaration that such threats are unjustifiable, and may secure damages unless the person making the threats proves that the acts of which he complained were or would be an infringement of a valid patent held by him.

Finally, the Act sets up a special Appeal Tribunal for the purpose of hearing appeals from decisions of the Comptroller in matters relating to the granting of patents. The Tribunal will consist of a Judge of the High Court, to be nominated by the Lord Chancellor, and is given power to examine witnesses on oath, to make rules regulating practice and proceedings therein, and to award costs.

NEWS of the WEEK.

Current Events in Brief Review.

Bristol Radio Week.

THE sixth annual Radio Exhibition in Bristol will be held in the Colston Hall from September 18th to 24th. The Radio Week opens with a service broadcast from the cathedral, when the Dean will give an address. A special studio is being erected in the hall, from which a number of broadcasts will be given by Bristol vocalists and instrumentalists.

The Manchester Exhibition.

AFTER Olympia the most important event to British manufacturers and radio enthusiasts is the Manchester exhibition, which is to be opened on Wednesday, September 28th, in the City Hall by the Right Hon. J. H. Whitley, chairman of the Governors of the B.B.C.

Radio Normandie's Progress.

THE enterprising directors of the well-known station at Fécamp are busy on the improvement of the service and are maturing their plans for the coming season. A new control panel is being installed, together with gramophone pick-ups and "effects" discs. At a banquet held on August 28th, with M. Leon Meyer—a Cabinet Minister and Deputy Mayor of Havre—in the chair, M. Fernand Le Grand, the president of its directors, after pointing out the service rendered to North Brittany and Normandy by this station, "created, worked and financed by themselves," announced their intention of starting a "vast competition" in which the prizes will include free trips and hotel accommodation at various resorts on the coast of Normandy.

Broadcasting in New Zealand.

THE Technical Committee appointed by the State Broadcasting Board to enquire into the best means of improving

the service of the four stations at Wellington, Auckland, Christchurch, and Dunedin, has recommended that these stations should be re-equipped and their power doubled—bringing Wellington 2YA up to 10 kW.—and that the other three should act as 1 kW. relay stations. Further relay stations may be provided by taking over some of the privately owned "B" stations. The problem of satisfactory broadcasting in the islands is somewhat difficult owing to the scattered nature of the population over the 1,000 miles from north to south. It is reported that there are now 75,000 receiving licences issued.

Television Tests.

A SYSTEM of television developed by the Marconi Company was demonstrated during the recent meeting of the British Association at York when televised messages were sent from the Marconi works at Chelmsford to St. Peter's School, York, a distance of 180 miles. The demonstration took the form of sending messages from characters printed on a moving tape passed through the transmitter at Chelmsford at speeds corresponding to sixty words per minute, the words appearing like a moving sign on a ground glass screen in the receiver at York.

Long-range Work.

SIMILAR tests have been in progress for some time between the Marconi Company's experimental beam station G2BS at Chelmsford (not G5SW, the B.B.C. short-wave station, as has been erroneously stated in some daily papers) and the Sydney station of Amalgamated Wireless (Australia), Ltd.

A Generous Gift.

THE new General Hospital at Southend-on-Sea is provided with a very complete radio installation, the gift of the Southend

BERLIN'S SHORT-WAVE AERIAL. A view of the aerial for 7-metre transmission on the summit of the famous Funkturm near Berlin.

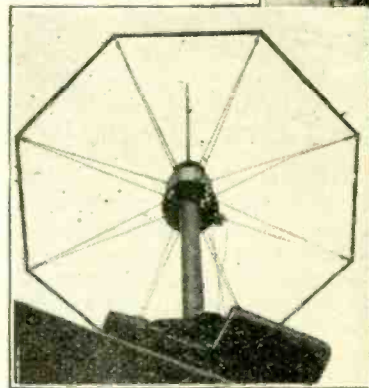

The quarter-wavelength aerial is seen through the ring-shaped counterpoise.

and District Radio Society, which was formally handed over to the authorities on September 6th. The installation includes 175 pairs of headphones, seventeen loud speakers, and it is proposed to supply forty "pillowphones" for the benefit of patients who require them. The society has already equipped and undertakes to maintain the installation at the old Victoria Hospital, but the maintenance of this far more extensive equipment was considered too great a responsibility to be undertaken by a society of only one hundred members, though two members have volunteered to visit the hospital once a week to deal with the repairs and adjustments of headphones and loud speakers.

Radio Research Board's Request.

DURING the evenings of September 1st and 2nd, observers at the Radio Research Station, Slough, picked up a station which was operating on a radio frequency of about 3.56 megacycles and sending out short-duration pulses at the rate of fifty per second. The signals were well received and photographically recorded at Slough, giving "echo" effects which make it of value and interest for the observers to know the location of the transmitter. Unfortunately no identifying call-sign was observed during the course of the transmissions, and the superintendent of the Radio Research Station, Slough, would be glad to have any information concerning the transmitter to assist in making an analysis of the observations.

An Enterprising Trade Publication.

THE Telsen Electric Co., Ltd., of Aston, Birmingham, has sent us a copy of the "Telsen Radiomag," which can now be obtained from any radio dealer or news-agent. Though, of course, chiefly devoted to apparatus of their own manufacture, the magazine contains many useful general articles on testing, the reading of response curves, and a "Hints and Tips" section.

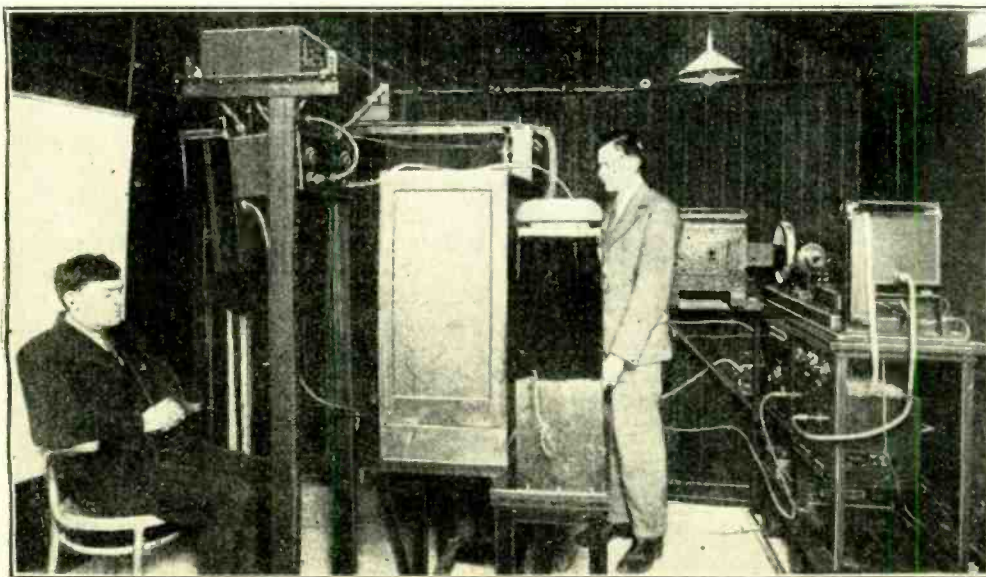

NEW TELEVISION TRANSMITTERS. The Marconi transmitters at Chelmsford used in their recent demonstration to the members of the British Association during their meeting at York. The apparatus on the left is for transmitting moving figures, that on the right for news messages.



BERLIN RADIO SHOW

A Review of the More Important Exhibits.

THE acute difficulties through which Germany is passing at the present time is given as the reason for the Ninth Wireless Exhibition, which has just been held in Berlin, not being supported, as in previous years, by the gramophone section of the industry. Although this has meant the omission of a number of important firms from the Show, the actual number of exhibitors was no less than last year. The gramophone industry had also given as a reason for keeping out of the Exhibition this year that it did not derive sufficient benefit because it was not permitted to demonstrate gramophones adequately.

It is stated that the German radio industry in the last half-year has suffered a decrease in exports to the extent of 50 per cent. by comparison with the first half-year of 1931, but the hope that the German home market would be sufficient to absorb the new sets appears to have been fulfilled, since orders taken at the Show have come well up to the expectations of the exhibitors.

The design of German broadcast receivers this year has naturally been influenced by the changing conditions in

has received very careful attention, and refinements have been introduced to minimise the picking up of local interference, as, for example, by the inclusion of choke coils in the supply leads from the mains. In spite of the exacting requirements of the modern receiver, Germany has succeeded in maintaining

a number of the sets, and in Telefunken, Siemens, and A.E.G. three-circuit receivers the volume control was included in the L.F. amplifier, which is a departure from the practice of most German designers.

As in this country, the superheterodyne asserted itself prominently at this year's Berlin Show, practically every manufacturer of repute having at least one model. These superheterodynes have one-knob control, and most of them have a high-frequency valve preceding the first detector, and, in some cases, this H.F. stage is preceded by a band-pass filter.

Automatic Volume Control.

In the Telefunken, Siemens, and A.E.G. circuits some form of automatic volume control has been introduced. Provision for short-wave reception was made in a number of German receivers, as short-wave reception is gaining in popularity in Germany. All-mains sets largely predominated, but there were a few very modern battery sets introduced for the first time.

The first German motor car set ("Ideal") attracted special attention. It



Te Ka De ultra-short-wave and television receiver.

(Inset) The mirror screw on which the image can be seen.

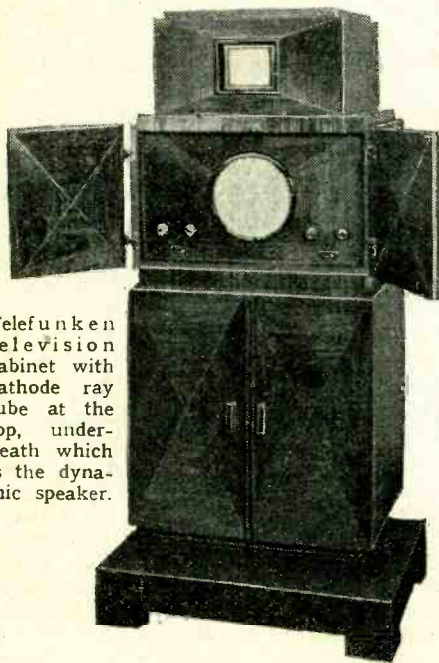
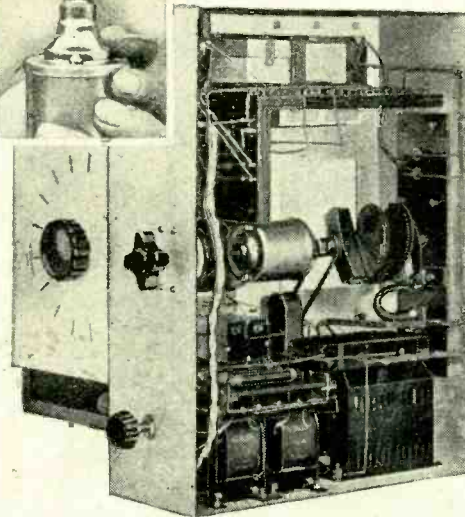

Telefunken television cabinet with cathode ray tube at the top, underneath which is the dynamic speaker.

reception, so that the outstanding improvements in receivers have been in the direction of increasing selectivity. The quality of components has been improved, and special arrangements have been made, as in this country, to ensure proper ganging in multi-valve sets. Screening, too,

mass-production methods, and prices were, if anything, lower than formerly. The fashion in small receivers has been to employ two valves, often with a screen-grid valve acting as detector and either a pentode or a good power valve as the output stage, and selectivity has been improved to meet the present requirements.

The next in order are the three-valve sets, but these did not seem to be so numerous as formerly, and most manufacturers appeared to have concentrated on two-valve sets and larger sets with variable- μ valves and two tuned circuits, power-grid detection, and a pentode as output. There were a number of examples of single-knob tuning.

Volume control in nearly every case was by variation of grid potential of the variable- μ valve. There were a number of three-circuit receivers to be seen, employing two variable- μ H.F. stages, and in a few cases four tuned circuits were included. Tone control was employed on

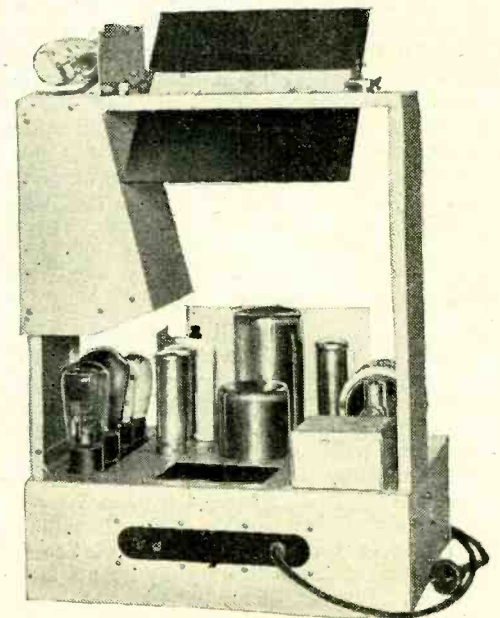

Rear view of Te Ka De television receiver. At the top left-hand corner can be seen the glow discharge tube.

is a five-valve superhet. with moving-coil loud speaker. The apparatus is mounted below the instrument board of the car, and it is stated that interference from the ignition is completely eliminated. The

Berlin Radio Show.

current for operation is taken from the starter battery, anode current being supplied from a small dynamo driven by the starter battery. The aerial is normally mounted below the frame, but in cars of closed type the aerial is included in the roof.

Gramophones and Home Recorders.

The firm Dr. Dietz and Ritter has brought out a portable equipment for microphone, broadcast, and gramophone-record reproduction. Germany appears

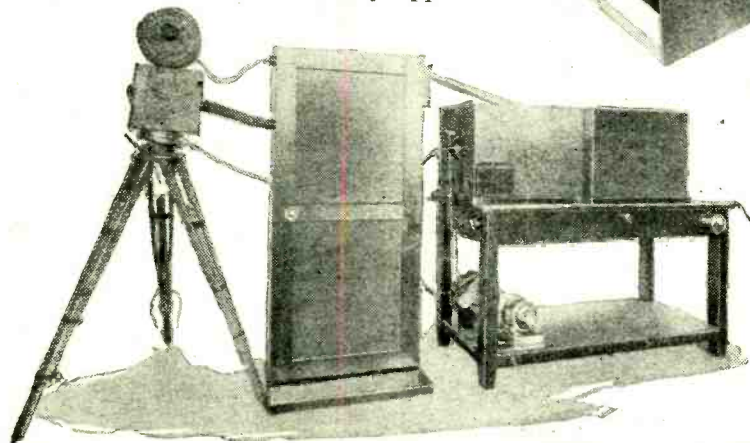

Laboratory assembly of television transmitter shown by the Fernseh Company. (Left) Film camera. (Middle) Cabinet for development of film. (Right) Television scanner.

to have excelled this year in the provision of gramophone mechanisms of high quality at very low prices. A flat induction motor by Bosch attracted particular attention. There were some interesting new models of gramophone pick-ups. In the Philips pick-up the needle is held by magnetic attraction in a wedge-shaped groove in the needle carrier, instead of being secured by a screw. Home-recording outfits were in evidence, and amongst novelties there was a recorder where the permanent magnet is replaced by an electro-magnet, energising current for which is taken from the anode current of the output valve.

A.E.G. was responsible for a very neat

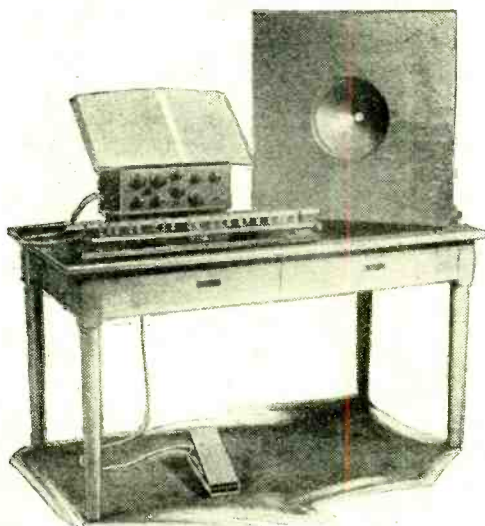

The new Telefunken "Trautonium" with pedal volume control.

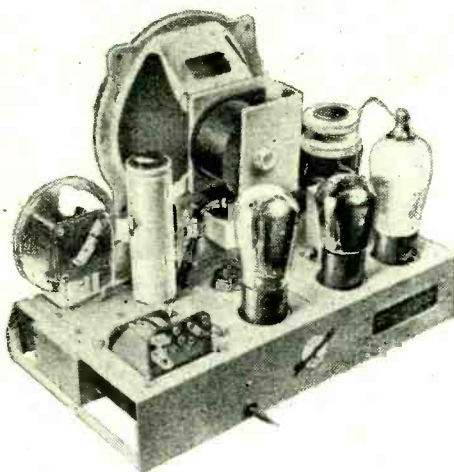

(Above) Chassis of the "Ideal" two-valve receiver with S.G. valve and pentode.

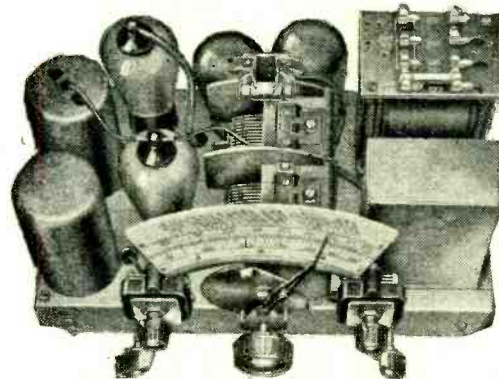

(Below) Telefunken two-valve receiver with screen-grid valve and pentode.

Saba three-valve two-circuit receiver.

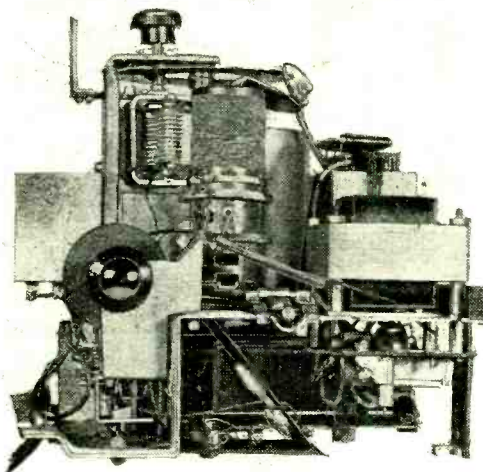

recording equipment, where everything was housed in a small box.

Loud Speakers.

Generally speaking, loud speakers did not exhibit any particularly new tendencies, although there were some examples which were outstandingly low in price. Amongst novelties there was a crystal loud speaker by Neufeldt and Kuhnke, employing two Rochelle-salt crystals. The same firm was exhibiting a pick-up designed on this principle. These exhibits created quite a lot of interest. The pick-up has an output stated to be as high as 5 volts.

A new electro-dynamic loud speaker was exhibited by Elektroton, having a flat grooved or serrated membrane, the quality from which was particularly good. Several of the German loud speakers this year employed diaphragms made in one piece and provided with stiffening ribs, the purpose being to avoid undesirable resonances. Electrostatic loud speakers

of a modified form were shown by Görler, and for public address and similar purposes Telefunken has produced a loud speaker combination which consists of two moving-coil loud speakers responding to high frequencies and working through short trumpets, whilst the lower frequencies are radiated by a special loud speaker having a large-area diaphragm.

Components.

The need for greater selectivity in Germany was brought home to the

visitor to the Exhibition by the large number of units exhibited at the Show which were intended to be used for increasing the selectivity of existing sets. Most of these attachments took the form of band-pass filter circuits.

A great deal of interest was shown in a new type of coil developed by Hans Vogt. These coils have a high self-inductance for a small number of turns, and are consequently much smaller in dimension than coils of the ordinary types. Although the secret of the new coils is the fact that they are wound on a particular form of core, they are stated to be ideal for use in H.F. circuits, having a lower H.F. resistance than very much larger coils of the same inductance wound in the ordinary way. In addition, it is claimed that these new coils can be screened without the screening having any effect of increasing damping or changing the inductance.

Other components of interest were new large tuning scales, and ganged condensers with particularly neat trimming devices;

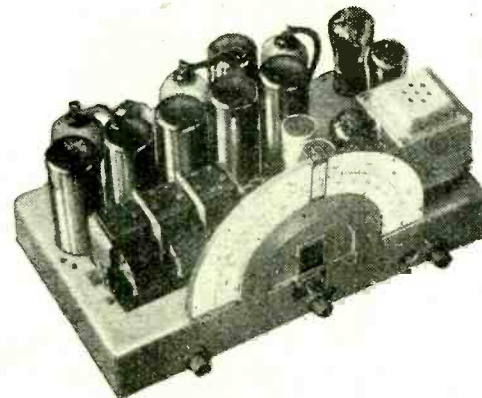

Chassis of the Sachsenwerks superheterodyne.

there were also new photo-cells, cathode-ray tubes, and glow discharge lamps, all by Pressler. Valves have improved

Berlin Radio Show.—
greatly since last year, but have, for the most part, followed the lines of development here and in other parts of Europe.

General Sections.

As in former years, the German Post Office took an active part in the Exhibition, and the Heinrich-Hertz Institute and the State Broadcasting Company were also adequately represented. In the Post Office section the centre of attraction was

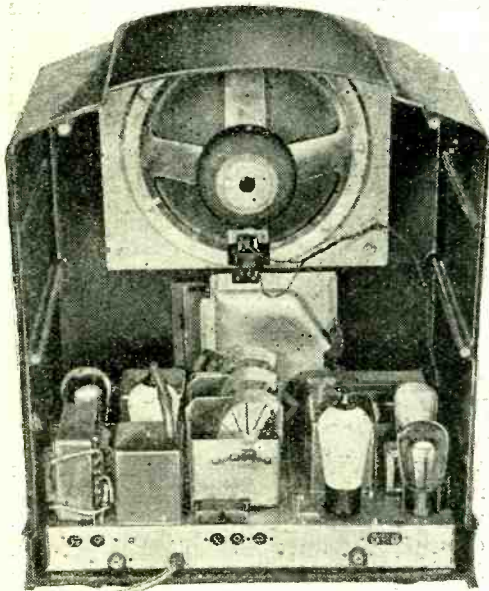

Chassis of the Telefunken four-valve three-circuit receiver with moving-coil loud speaker.

the recently constructed high-power ultra-short-wave transmitter, which was in actual operation, transmitting both television and sound programmes. The aerial was erected on a 150-metre tower, and consisted of a vertical dipole connected to the transmitter by a special high-frequency cable. The way in which modulation of the ultra-short-wave transmitter is observed is interesting. Part of the oscillating current is sent through a coil, at the end of which is a carbon point; as the oscillations build up in the coil this carbon point grows so hot that eventually

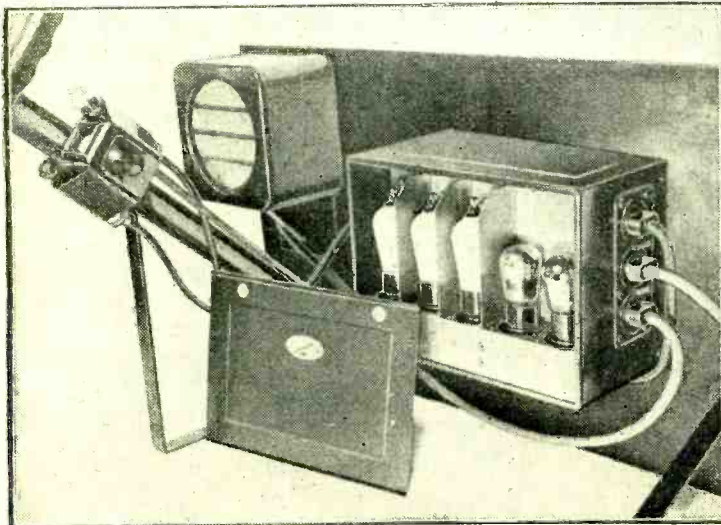

The "Ideal" motor car receiver showing the contrl box.



Amplifying equipment for microphone and gramophone (Dr. Dietz and Ritter).

a pointed flame emerges from it and gives a single note under the influence of modulation. The longer the flame the greater the depth of modulation. The output from the transmitter is measured by passing the oscillations through a liquid re-

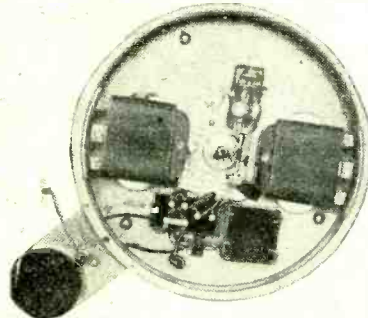

Two views of the Bosch gramophone pick-up and motor.

sistance and measuring the rise in temperature.

The television transmissions were undertaken by the Post Office on the ultra-short-wave station. The Fernseh Company provided the actual television apparatus for the purpose. Participants in television apparatus were the Post Office, the Telefunken Company, Te Ka De, Fernseh Company, and Loewe-von Ardenne. Definition has been undoubtedly improved by increasing the number of lines,

Interest is directed to ultra-short-wave transmission, and important developments have taken place with what is referred to as "intermediate-film-television" transmission. Telefunken was demonstrating a cathode-ray receiver for the first time. This gave a picture image about 15 centimetres wide. The apparatus was in cabinet form, and included a loud speaker. In addition to the cathode-ray receiver, Telefunken was also showing a big receiver with the Wieller mirror wheel giving reasonably bright and fair images 50x60 centimetres in size.

The Te Ka De receiver was of special interest, and included a "mirror screw" combined with an ultra-short-wave receiver. The firm Loewe-von Ardenne showed a cathode-ray transmitter using a new cathode-ray tube by von Ardenne and made by Loewe.

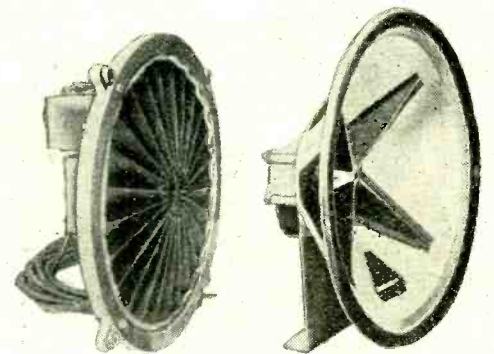

(Left) Elektrotron loud speaker with stiffened flat diaphragm. (Right) The Kriebelphon inductor-dynamic speaker with stiffened diaphragm.

Perhaps the most interesting exhibit of all in the television section was the new apparatus for the "intermediate-film" process referred to above. It is well known that televising living objects and natural landscape by direct scanning is extremely difficult, since with the number

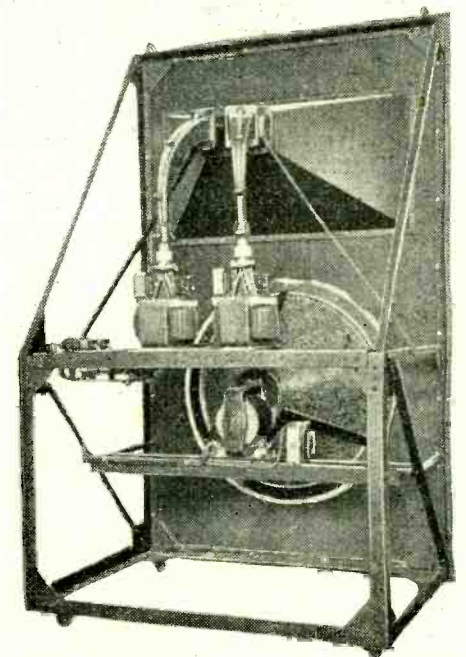

Klangfilm-Telefunken loud speaker used at the Berlin Radio Show.

of elements demanded the subjects are not sufficiently bright in illumination. The

Berlin Radio Show.—

Fernseh Company has, therefore, developed the arrangement whereby the picture is first filmed and then the film projected by television. The idea is not new, but what is, we believe, original in the arrangement is that in the Fernseh Company's process the developing and fixing of the film can be accomplished in twenty seconds, so that the apparatus for taking the film and for its scanning can be built

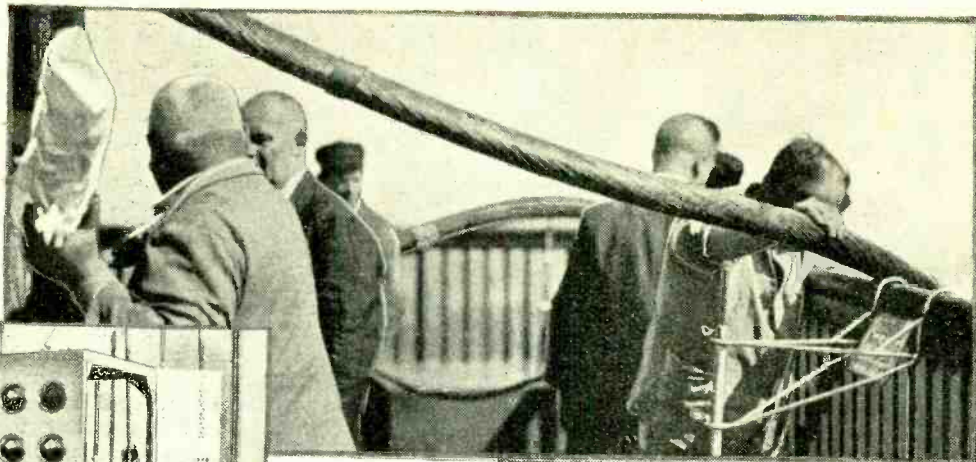

Laying the radio frequency feeding cable from the ultra-short-wave transmitter to the dipole aerial on the tower.

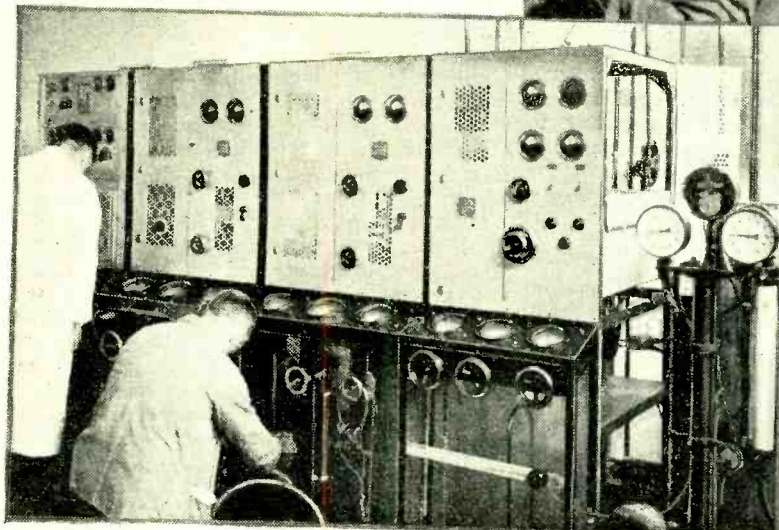

The ultra-short-wave transmitter in the old Radio Hall.

as one whole. This result has been made possible by the Zeiss-Ikon Company, which has evolved a special film of high sensitivity and requiring a very short

A number of interesting musical instruments were shown. The Heinrich-Hertz Institute has in previous years specialised in accommodating exhibits of musical instruments associated with electrical circuits, and last year sponsored the "Trautonjum," which is now built by Telefunken. This is being shown again this year. It

comprises an oscillation generator, the plain manual (keyboard), and a pedal as volume regulator. It can be attached to

any amplifier. The Institute also showed a small attachment for the production of Theremin "ether vibrations" for connecting to the pick-up terminals of any broadcast receiver. The cost is only 100 marks.

Another instrument shown was the Vierling piano, resembling the Siemens-Bechstein-Nernst grand piano, but giving some new effects.

A special display was given in another section of the Exhibition to devices for eliminating interference from electrical machinery, and demonstrations were given of the application of new low-capacity screened cable for screening aerial down leads. Reference has already been made in *The Wireless World* to this cable. The arrangement is being extensively adopted in Germany

for screening the down leads of outdoor aerials used for ordinary broadcast receivers.



The singing flame which shows the modulation of the ultra-short-wave transmitter.

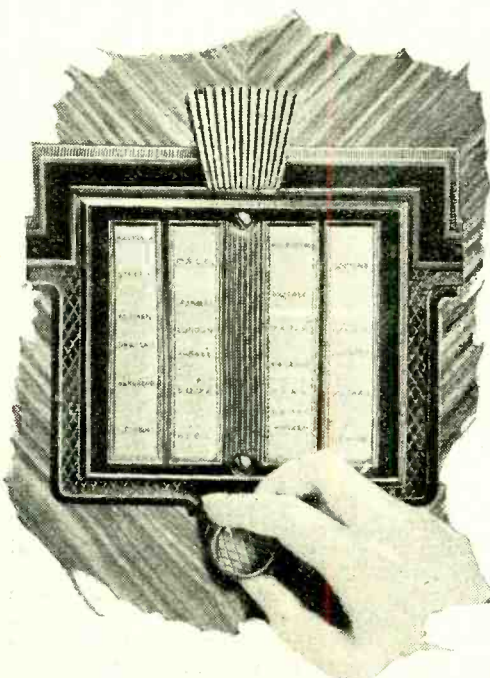

Optical station finder. A wandering beam of light facilitates tuning.

time for development, and also by making it possible for the film to be scanned whilst still wet. At first, moisture remaining on the film tended to blur the image, but this has now been overcome in an ingenious way by the employment of a special automatic wiper which effectively permits the definition to be retained, while having considerable time.

SHORT-WAVE H.F. AMPLIFIERS.

INTEREST in short-wave reception continues to grow apace both in this country and on the Continent, and several types of short-wave receiver are now available. These consist for the most part of simple regenerative receivers and special adaptors for converting broadcast receivers into short-wave superheterodynes. Quite a number of three-valve short-wave sets have appeared, however, in which an H.F. stage, using, of course, a screen-grid valve, is employed. The actual amplification given by the H.F. stage is exceedingly small, and many people are inclined to wonder whether its employment is justified. The answer is that if it were to be judged solely on its merits as a pure H.F.

amplifier very little could be said in favour of it.

The End Justifies the Means.

In actual practice, however, it is responsible for producing a fineness of reaction control quite unobtainable with the orthodox regenerative circuit, and since reaction can provide an enormous amplification when capable of critical adjustment the end more than justifies the means. In the case of at least one highly efficient receiver the S.G. valve is resistance coupled to the detector and, of course, the degree of amplification due to the H.F. stage itself is practically nil.

Correspondence.

The Editor does not hold himself responsible for the opinions of his correspondents. Correspondence should be addressed to the Editor, "The Wireless World," Dorset House, Tudor Street, E.C.4, and must be accompanied by the writer's name and address.

Micromesh Valves.

IN your issue of August 5th you were good enough to publish an article on our new Micromesh valves, and while we greatly appreciate this, we would ask you the favour of granting us space in your columns to modify one or two of the statements that appeared in the article.

Considerable progress has been made recently in the design and manufacture of Micromesh valves, with the result that certain of the data upon which your article was founded are now obsolete.

The method of assembly now comprises the use of a unitary type of structure. In this structure all of the elements are assembled and secured together before they are mounted on the stem. In adapting this unitary type of construction, which greatly facilitates manufacture, we have been enabled to use an inclined type structure, and at the same time to reduce the number of wires in the press from seven to five. We have also been enabled to eliminate the lower cathode support. The guiding of the cathode by a separate member has been abandoned and is now being accomplished by the top mica. Twin bore quartz tubing for housing the heater wire was used only in the earlier models. We now use a refractory coating on our pure tungsten heater wire for insulation.

With regard to the heating of the valve, we can definitely state that the temperature of the glass bulb under present methods of manufacture does not become any higher than is usual for other valves of this type, and it is not therefore necessary to provide special ventilation in the cabinet.

Finally, it should be stated that only 25 seconds, not 50 seconds as stated in your article, are now necessary for the valve to attain its full emission state.

London, W.C.1. F. A. COBB,
Standard Telephones and Cables, Ltd.

The Question of Quality.

WILL you kindly allow me a word on the "Quality" question?

Amongst the array of receivers on the market last season, one in particular gave really fine reproduction, another was very good, and the remainder moderate, this latter class representing the majority of the commercial receivers.

However, the first-mentioned set was useless as a commercial proposition on account of its astounding lack of selectivity; whilst the second set remarked upon had poor inherent selectivity (note the qualifying word).

Now here is the point I wish to make (apart from the question of selectivity and judging purely by quality of reproduction). Receiver number one, and to a lesser extent number two, gave very decided amplification of the extreme upper register, with no sideband cutting, naturally.

When a customer heard these two sets demonstrated, he, in ninety-nine cases out of a hundred, immediately complained of the sharp, cutting tone, and upon hearing an example of class number three exclaimed: "Oh! How nice and mellow!"

The above comments were also made by people who should have known better, but the fact remains that the present manufac-

turers' policy is, to my mind, due not only to the difficulty of combining quality with selectivity, but to a greater degree to the lack of public demand for a receiver capable of reproducing the upper register faithfully. They much prefer a set having a cut-off at 3,500 to 4,000 cycles, and the word "mellow" admirably expresses their requirements.

This letter may provoke severe comment, but perhaps other traders can testify to the truth of the foregoing.

Wrexham. R. FRANCIS ELLIS.

The Value of Discussion.

CONGRATULATIONS on the enlarged *Wireless World*. This new feature greatly enhances its value. It really is two papers in one. May I, as a very "ordinary listener" who possesses no delicate instruments, no great technical knowledge except what he has attained through the medium of your valuable journal, thank you for the letters you have published on the important subject of quality and frequency range. They have been most helpful, although some of them take me a bit out of my depth, and I can assure C. J. Tomes that your valuable space has been in no way wasted, and A. H. B. Cross that C. J. T. does not represent a very large proportion of the "ordinary listeners" who read *The Wireless World*.

I would like to suggest to C. J. T. that if he would follow my example he would discover how much the practical application of

the facts contained in letters from various well-known gentlemen can help towards attaining the goal of perfect reproduction.

I was using a *Wireless World* home-constructed Band-Pass Pentode III in conjunction with a well-known loud speaker.

I thought it perfect!

Then I read that "bickering" between Messrs. West and Hartley, letters by Bonavia Hunt, P. K. Turner and others.

I realised that my outfit was cutting off at about 5,000 cycles.

Then I tried various stunts with the output circuit of my set, but they did not improve matters at all. It was the loud speaker!

Not having much spare cash, I had to hunt round for the best means to improve reproduction for the smallest outlay.

Turning to *The Wireless World* again, I read your report on an electrostatic speaker, and a suggestion of using it in conjunction with an M.C. speaker, as it had a response up to at least 15,000 cycles. Now I had a big bass output from my original speaker, and what I wanted was an increase in the upper register, so I purchased one of the electrostatic speakers, and the results are most realistic.

Now, if it had not been for the letters you have published in *The Wireless World*, I should still have been content with reproduction ranging from about 50 to 5,000 cycles.

Let's have some more "bickering," please!

H. BRADSHAW.

Bishop's Stortford.

The Tuning Note.

CONGRATULATIONS on your editorial *re* the tuning note.

The idea of a rising tone is what we have all been waiting for; gramophone records are all very well in their way, but are useless for tests on the H.F. side.

May I suggest tentatively a note starting at 32 cycles and rising logarithmically with time as follows:—

32	½ minute
64	" "
128	" "
256	" "
512	" "
1024	" "
2048	" "
4096	" "
8192	" "

Total 32—8192 cycles in four minutes.

Apart from the tremendous value to experimenters, the scheme would do much to educate the general public in the matter of quality.

The owner of the set with the "fine mellow tone" who only heard two minutes' tuning note instead of the four which should be there would perforce begin to think.

Certain M.C. speaker manufacturers who rely on a 90-cycle surround resonance for their lease (including one of the most famous firms in the country) would have to do something about the nasty gap which would follow the start of the note at 32 cycles. Now that the idea has been mooted I hope *The Wireless World* will not rest until it is an accomplished fact.

S. FALLOON.

Southfleet, Kent.

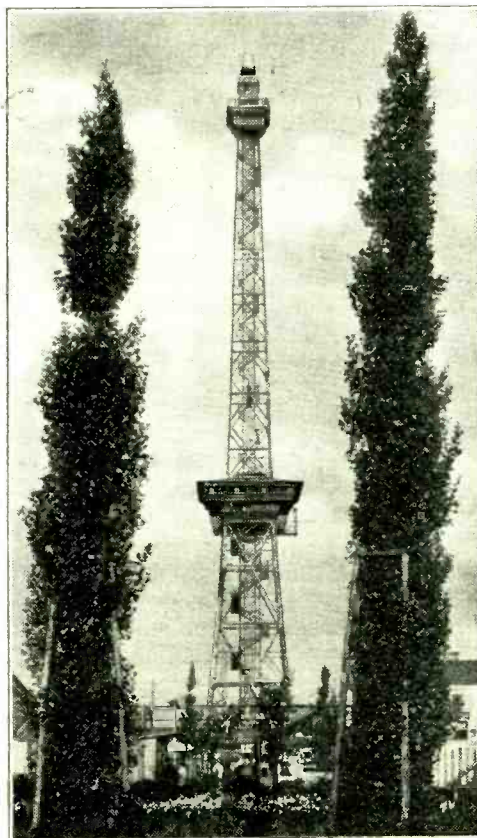

The wireless tower which is a familiar landmark at the Berlin exhibition ground. An illustrated report on the Berlin Radio Show appears elsewhere in this issue.

Next Week's Set Review:—

STANDARD BATTERY Co.'s
FUTURA 6.

TRIX 50-WATT POWER AMPLIFIER. TYPE T.225.

A.C. Operated Three-stage Amplifier giving 16 Watts Undistorted Output.



In the upper compartment are housed the four amplifying valves, the mains rectifier and the tone control.

THAT the microphone, electric amplifier and loud speaker find many useful applications outside the sphere of wireless broadcasting is evident by the number of specially designed amplifiers now available for use at sports meetings, open-air fêtes and events of a like nature as the medium for disseminating information, making announcements and broadcasting other pertinent matter relating to the occasion. A further advantage of this system is that by the addition of a simple gramophone unit music can be relayed to all parts, thereby affording a measure of entertainment during intervals in the programme.

Smaller versions of these amplifiers are now available for domestic use, such as for gramophone reproduction or in conjunction with home cinema projectors and synchronised sound films.

Eric J. Lever (Trix), Ltd., has for long made a speciality of low-frequency power amplifiers of this type, and their very extensive range includes small models of a few watts output in addition to large power handling equipment suitable for operating loud speakers at open air meetings.

FEATURES.

General.—Three-stage power amplifier giving 16 watts undistorted output. Operates on A.C. 10-60 cycles at 100, 200-240 volts.

Circuit.—First stage resistance-capacity coupled; second parallel-fed L.F. transformer; last parallel valves followed by filter-fed output transformer giving ratios of 10:1, 18:1 and 26:1. H.T. from half-wave mercury vapour rectifier.

Controls.—Tone control.

Price.—£35 complete with valves.

Makers.—Eric J. Lever (Trix) Ltd., 8/9, Clerkenwell Green, London, E.C.1.

The type T.225, with which tests have been carried out recently, would come within the latter category, for it is rated to give a maximum undistorted power output of 16 watts. Although somewhat excessive for normal home use there are occasions when an output of this order might be desirable even in an enclosed space, an example being the reproduction of dance music in a large hall.

It is A.C. operated and embodies three amplifying stages, the output being derived from two DO.25 super power valves working in parallel. But for a somewhat unusual system of tone control the circuit is quite straightforward and consists of one resistance-capacity coupled stage followed by a transformer coupling, the latter being used in conjunction with a parallel-feed circuit.

The heater current for each valve—and there are five in all including the rectifier—is derived from separate windings on the

put from these valves is combined and passed to a step-down transformer, the secondary winding of which is tapped and provides the means for matching the loud speaker to the valves.

The arrangement of this part of the circuit is interesting as two feed condensers are included so as to assure a truly symmetrical system, a condenser being joined between the centre tapping on each output valve filament winding and the low potential end of the primary winding of the output transformer. For the same reason two condensers are employed for decoupling the grid circuits.

Mercury Vapour Rectifier.

It is small points of this nature that give individuality to the amplifier and exemplify the meticulous care devoted to its design. Decoupling has been applied very thoroughly to the earlier stages, but

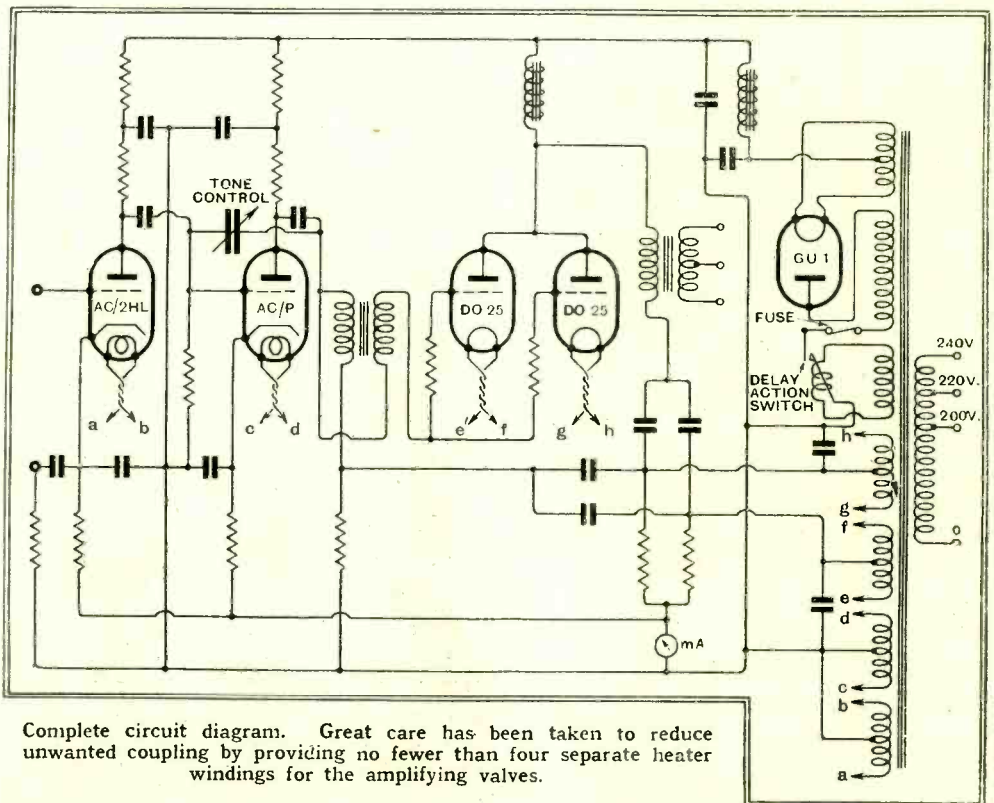

Complete circuit diagram. Great care has been taken to reduce unwanted coupling by providing no fewer than four separate heater windings for the amplifying valves.

mains transformer. So far as the first two stages are concerned this is purely a precautionary measure, but it is very necessary in the case of the output stage where the valves are directly heated. It assures that in the event of one valve failing the other will not suffer damage. Each has its own grid bias resistance, also a separate resistance in the grid circuit to suppress parasitic oscillations. The out-

it is used with discrimination and then only where there is a real need for it; thus we find it omitted from the grid circuit of the penultimate valve where its inclusion would serve no useful purpose.

High tension is obtained from a G.U.1 mercury vapour valve giving half-wave rectification, and the smoothing is carried out by a single L.F. choke and the customary arrangement of condensers. This

Trix 50-Watt Power Amplifier.—

system is perfectly satisfactory in the present case, for there is but a mere trace of hum audible only within a foot or so of the loud speaker. A thermal delay switch is included, since this is an essential fitment when the G.U.I. rectifier is employed, as it allows about one minute to elapse after switching on before the load is applied to the rectifier.

No provision has been made in the amplifier for controlling the volume, a justifiable omission, since in any case it will be far more convenient to have this control on the turntable unit which, incidentally, might well embody the microphone and its control. As a matter of interest the makers have developed various models of turntable units, some fitted with dual motors, pick-ups, fading and mixing devices, also change-over switches for bringing a microphone into use when required.

The performance of the model T.225 is in every way exemplary, the amplification is maintained at a satisfactorily high level down to 50 cycles, this being the lowest frequency actually applied when investigating its characteristics. There is, however, an adequate output right down to the lowest limit of audibility.

With the tone control set to the "high" position—curve A on the graph—the amplifier exhibits a slightly rising characteristic with the peak frequency at about 4,000 cycles. At this point the amplification level is about 3.5 decibels above that at 50 cycles.

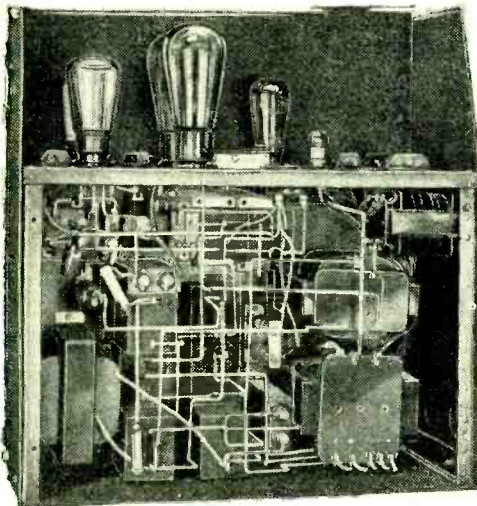

The amplifier with front cover removed, showing the particularly neat wiring scheme.

The tone control does not produce a very marked effect, indeed apart from a slight reduction in the general level it has a negligible effect below 1,500 cycles, its effect being noticeable only at the upper end of the audible scale.

These curves show the overall amplification from the grid of the first valve to the output side of the terminal transformer, and were taken with an equivalent resistive load connected across the 18:1 tapplings. Incidentally the other ratios available are 10:1 and 26:1 respectively.

It will be seen from curve B that with the tone control set to "low" the am-

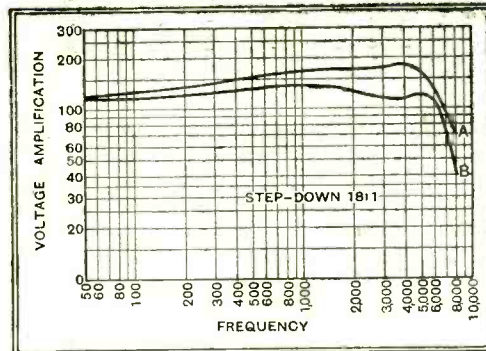

Overall response curves (A) when tone control is turned to "high" and (B) when changed to the "low" position.

plification at 5,000 cycles is brought down to the same level as at 50 cycles, and although this introduces a not-too-well-defined peak at 1,000 cycles to be followed by a valley at 3,500 cycles these do not amount to more than an increase of 1.2 decibels and a decrease of 0.4 decibel respectively as compared with the 50-cycle

DISTANT RECEPTION NOTES.

LAST week I mentioned that good use might often be made of the directional properties of the frame aerial at times when atmospherics were a nuisance. The frame can also render another service that many long-distance men do not realise. Let me give an example to show just what I mean: On tuning in Kalundborg with a superheterodyne receiver the other afternoon I found a transmission coming in so strongly that considerable use of the volume control was required; the programme, however, was not fit to listen to owing to the presence of a loud C.W. signal on practically the same wavelength. Rotating the frame slowly, I found that there was a position at which the Morse signal entirely disappeared, though Kalundborg could still be heard. By moving the volume control knob Kalundborg was brought back to full strength without a trace of the interference.

Worth Remembering.

This kind of thing can frequently be done, since in the first place it is unlikely that the interfering signal will come from exactly the same quarter as the wanted transmission, and, secondly, the directional properties of the frame are very much more marked for the minimum than for the maximum position. There is another rather interesting point about frames of which again good use can occasionally be made. It is found sometimes, particularly, I think, if one end of the windings of the frame is earthed, that it tends to become *uni-directional*. That is to say, if a station is tuned in to maximum strength by pointing the frame towards it, it may be found that there is an increase or decrease if the frame is turned through 180 degrees. It is as well to discover if the frame aerial of one's own set behaves in this way, as it may be useful.

There is at the present time one outstandingly good portion of the medium waveband. This covers the wavelengths between roughly 380 and 510 metres. This belt of wavelengths the reader should not fail to visit, for he will find there the maximum of both signal strength and quality and the minimum of Morse and heterodyne interference.

level. An aural test will not reveal their presence, and only the reduction in amplification of the frequencies above 7,000 cycles will be apparent to the ear.

Using a good loud speaker the reproduction can best be described as brilliant, speech is crisp and clear, and orchestral passages are reproduced faithfully.

The amplifier is housed in a strong iron case finished in crystalline black, and is provided with substantial back lugs for fixing to a wall. The valves, tone control, and all connection points are located in the upper portion of the case, access to which is obtained by raising the hinged cover.

Internally the workmanship is fully in keeping with its fine external appearance, the wiring is neatly executed, being carried out with stout wire run in insulating sleeving. The mains transformer, chokes, and output transformer are products of the firm, while all other components bear the stamp of well-known manufacturers whose wares have proved their worth in the wireless sphere.

It contains also a large selection of the best stations sending out first-rate programmes. Working upwards from the bottom we have Lwow, well received by those whose sets are selective enough to tune out the neighbouring (from a wireless point of view!) Scottish Regional. Next comes Toulouse, whose quality unfortunately is not quite equal to its volume. Frankfurt is on most evenings a good station; Sottens has shown a very great improvement recently, and Katowice is now qualifying for inclusion amongst first-class stations. Berlin Witzleben is apt to be disappointing, but Belgrade has many good evenings. Stockholm and Rome are completely reliable. Beromunster is splendidly received now. Lyons Doua makes intermittent appearances with fine strength, but Prague, Florence, and Brussels No. 1 are always ready to provide entertainment.

The number of stations on the medium waveband which can be received in broad daylight is considerable. No great amount of high-frequency amplification is required to obtain loud speaker reception from Brussels No. 1 at any time when he is working; Langenberg, though not so strong, is usually to be heard. Rome, though not reliable by daylight, may be found sometimes, even in the morning. Others worth trying for in the daytime are Mühlacker, Hilversum, Heilsberg, and Turin. D. EXER.

The Wireless World INFORMATION BUREAU.

THE service is intended primarily for readers meeting with difficulties in the construction, adjustment, operation, or maintenance of wireless receivers described in *The Wireless World*, or those of commercial design which from time to time are reviewed in the pages of *The Wireless World*. Every endeavour will be made to deal with queries on all wireless matters, provided that they are of such a nature that they can be dealt with satisfactorily in a letter.

Communications should be addressed to *The Wireless World* Information Bureau, Dorset House, Tudor Street, E.C.4, and must be accompanied by a remittance of 5s. to cover the cost of the service. The enquirer's name and address should be written in block letters at the top of all communications.

LABORATORY TESTS

New Radio Products Reviewed

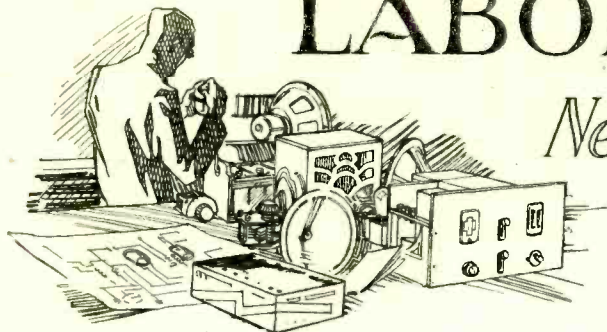

MILNES H.T. UNIT.

A PERIOD of approximately two years has elapsed since first we tested the Milnes H.T. Unit, and it is significant to record that during the interim very little change has been deemed either necessary or desirable in the design. The main feature of the unit is, of course, the novel method of replenishment, for the charging current is derived from a 6-volt L.T. battery, yet it provides an H.T. supply of from 90 to 200 volts, according to the size of unit installed.

The Milnes Unit is a storage battery and consists of a number of small cells in which is fitted "Alkum" nickel and iron plates immersed in an alkaline solution. Sulphation is impossible, and, furthermore, the battery can be charged and discharged at any reasonable rate without fear of damage.

In the 120-volt unit there are ninety-six cells in all, arranged in groups of four cells, twelve groups being accommodated on each side of a long drum-type series-parallel switch. In the "charge" position all the groups are connected in parallel, and the normal potential is then approximately 5 volts. When the cells are fully charged, however, the potential of each group rises to the same voltage as that of the charging accumulator, and, as an electrical balance is now attained, current ceases to flow into the unit. Thus the switch can be left in the charging position whenever the receiver is not in use, and no wastage of L.T. current will accrue.

We have tested one of the latest Milnes Units and find it perfectly satisfactory. Apart from a few minor improvements, it would seem to be much the same as the earlier specimen examined. An all-night

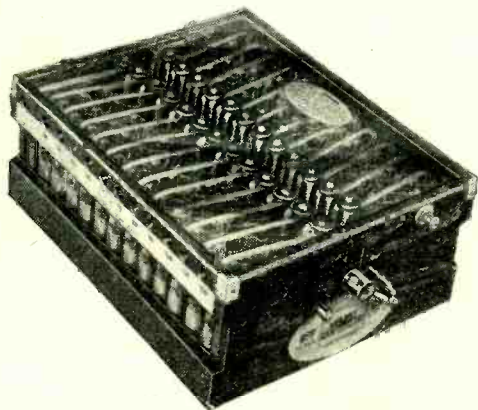

Milnes H.T. supply unit which can be re-charged from a 6-volt L.T. battery.

charge from a 6-volt accumulator suffices to keep the battery in tip-top condition, and there is very little additional work imposed on the L.T. battery, for it is necessary only to make good the few watts taken by the set in the form of H.T. during the

course of the day, and when again fully charged the process is automatically arrested.

The makers are Milnes Radio Company, Cottingley Bridge, Bingley, Yorks, and the prices are £2 18s. for a 90-volt unit, £3 16s. for one of 120 volts, and £4 14s. for a 150-volt size.

CLAUDE LYONS Q.M.B. SWITCHES.

THESE switches are now made in this country by Claude Lyons, Ltd., 40, Buckingham Gate, London, S.W.1, to the same specification as the well-known B.A.T. Arrow H. & H. Q.M.B. switches. Identical machinery is employed, so that these switches are in every respect exact replicas of the American-made article.

The range at present available includes some twelve different models, of which six are rated to handle 3 amps. at 250 volts,

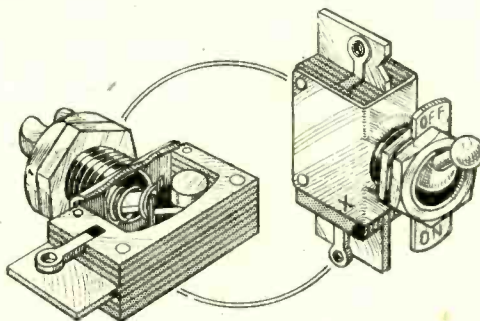

Lyons B.A.T. Arrow Q.M.B. switch, showing operating mechanism.

while the remainder will deal with currents up to 5 amps. at 250 volts. The switch operates by spring tension, which assures a quick make-and-break action, and makes for a good electrical contact under all conditions.

The small 3-amp. models are available as on-off, single-pole change-over and three-point switches, the price being 1s. 6d., 1s. 9d., and 2s. respectively.

To facilitate ganging the switches with volume controls and the like, models are obtainable fitted with a slotted control lever in place of the ball fitment used in the panel-mounting models.

KINVA TONE-CORRECTION COILS AND H.F. CHOKES.

A RANGE of special coils designed on the lines of the tone-correction choke used in *The Wireless World* "Autotone" receiver has been introduced by Postlethwaite Bros., Church Hill, Kinver, Stourbridge. These are available in inductance values of 0.1, 0.3, 0.5, and 1.0 henry, the prices being 3s. 6d. each for the first two mentioned, and 4s. 6d. and 5s. 9d. for the 0.5 and 1.0 henry sizes respectively.

These coils are particularly well made, being wound on small ebonite formers, which, in the case of the two specimens

tested, are $\frac{1}{8}$ in. in diameter and $\frac{1}{4}$ in. wide. We found the inductance of these specimens to be within 3 per cent. of their marked values, while the D.C. resistance of the winding is quite low for a coil of such small physical size. For example, we found the D.C. resistance of the 0.1 henry specimen to be 107 ohms, while that of the 0.3 henry model 290 ohms.

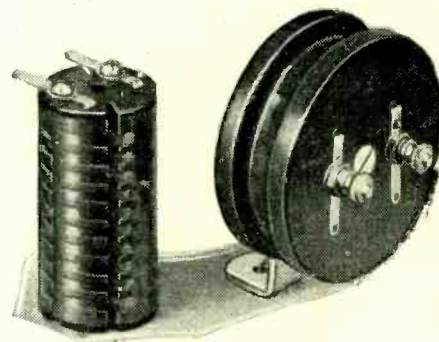

Kinva tone-correction coil and special manufacturers'-type H.F. choke.

The firm has developed also a special series of Kinva slot-wound H.F. chokes for the set manufacturer. They are made in four sizes ranging in inductance from 80,000 microhenrys to 180,000 microhenrys. Soldering tags are provided in place of terminals, and all unnecessary "frills" are omitted so that these models can be produced in the most economical manner. The range covers all normal requirements, including that of superheterodyne receivers.

HARBROS INSULATED AERIAL WIRE.

MADE by Hart Bros. Electrical Manufacturing Co., Ltd., Queensway, Ponders End, Middlesex, Harbros Insulated Aerial Wire is equally well suited for indoor or outdoor use. In view of the good insulating properties of the covering the wire may be secured to the picture rail without the addition of insulators, and since the covering is weatherproof, also impervious to moisture, these could be dispensed with even when the wire is used for an open aerial.

It consists of a core containing seven strands of No. 24 S.W.G. copper wire enclosed in a double covering of cotton, over which is a closely woven and impregnated cotton braiding. The outer covering is particularly tough and will withstand quite hard usage without impairing the insulation, but sharp bends in the wire should be avoided as far as possible.

It is supplied in coils containing 50 feet, 75 feet, and 100 feet, the prices being 1s. 9d., 2s. 6d. and 3s. 3d. respectively.

J.B. Condensers.

On page 203 of the August 26th issue the price of the two-gang "Unitone" condenser was given in error as 27s. This is the price of the three-gang model, and the two-gang unit, together with disc drive and bakelite escutcheon, costs 18s. 6d. It should be noted also that the short-wave "Special" is an entirely new product.

READERS' PROBLEMS.

THESE columns are reserved for the publication of matter of general interest arising out of problems submitted by our readers. Readers requiring an individual reply to their technical questions by post are referred to "The Wireless World" Information Bureau, of which particulars, with the fee charged, are to be found on page 286.

Built-in Bias Cells.

IN order to reduce the number of connecting leads between set and batteries, and also to reduce the number of the batteries themselves, it is quite a common practice for the manufacturers of commercial sets to fit a combined H.T. and grid-bias battery. To do so is, of course, quite legitimate, but this practice seems to have confused a reader who wishes to use an output valve of greater power than that standardised in his receiver.

As the new valve will consume much more anode current than that originally supplied, he has wisely decided to employ "super capacity" batteries in place of those normally fitted. His difficulty is that the make of battery chosen is not provided with a built-in bias section, and he cannot see how connections should be made, as there is no terminal on the receiver corresponding to "G.B.+" We are asked to give a simplified diagram of connections.

Fig. 1.—Replacing a combined H.T. and grid-bias battery with separate batteries. Inset: explanatory diagram of original connections.

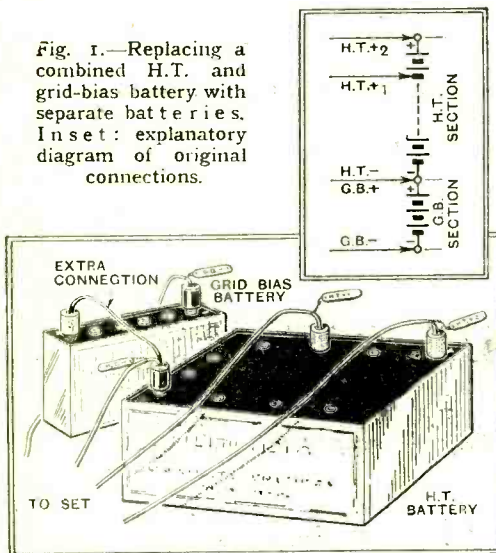

The absence of a special lead for connection between the set and the positive side of the bias battery is easily accounted for when we remember that this latter point would normally be joined internally to the H.T.—terminal. Of course, with a common H.T. and bias battery the necessary inter-connection already exists in the battery itself.

As our correspondent is using separate cells, an extra lead must be added in the manner shown in the accompanying diagrammatic sketch.

"Microphonic" Condensers.

A QUERIST who has recently constructed a superheterodyne receiver, in which the principles laid down by contributors to this journal have been followed fairly closely, tells us that both the sensitivity and selectivity of this set exceed expectations, but when volume is increased to anything approaching a comfortable level of intensity, a microphonic effect becomes evident.

Naturally enough, he attributed this to the second detector valve, but an experimental replacement of this valve with another that is known to give good results in a similar but rather less ambitious set resulted in no improvement. The first detector and several other valves have also been subjected to a test by substitution, with negative results; we are asked to suggest other possible sources of microphony.

As our reader goes on to say that his set is built into a radio-gramophone cabinet with a self-contained loud speaker, we are strongly inclined to suspect that vibration of the condenser vanes is responsible for this trouble. It may be possible to cure it by suitable acoustic shielding, but it would probably be much better to mount the entire receiver on insulating blocks of sponge rubber. Alternatively, it may be more convenient to insulate mechanically the tuning condenser only.

For Steel-framed Buildings.

"SITUATION is more than set" is an axiom that has often been put forward in these pages with regard to the performance of wireless receivers. Any further proof of its truth that may be needed is provided by the experience of a correspondent who has just moved up from the country for a six months' sojourn in Town.

His A.C. superheterodyne, which was a model of everything that it should be in the matter of range and sensitivity, has now degenerated into what he describes as "a local station receiver." Its condition has been checked, and, as the anode current of all valves remains unchanged, he rightly concludes that this falling-off must be ascribed to local conditions.

The set is now installed in a flat in a steel framed building, and is operated with an inside aerial, which naturally is screened by the structural steelwork. We are asked to recommend some more efficient type of collector, with the proviso that it is quite impossible to erect an outside aerial.

Here we must admit to being practically "stumped." Even with full knowledge of the circumstances it would be difficult to make any useful suggestions, although it occurs to us that our correspondent may have forgotten to try the effect of a mains aerial. Under the conditions described, this form of collector is often much more effective than the best of inside aerials.

There is also a possibility that it might be possible to lower a length of insulated wire from one of the windows; it should be kept as far as possible from the outside walls. Although inefficient, this type of aerial would probably not suffer quite so badly from the effects of screening as the arrangement at present in use.

Comparative "Goodness."

A READER asks us whether there is any simple method, which does not involve the use of laboratory apparatus, of com-

paring the losses in two "potted" tuning coils. He goes on to say that it is desired to make a test that is beyond criticism on technical grounds, but that it is unnecessary to make quantitative measurements.

We do not know of any really simple method that will indicate the relative efficiency of coils of dissimilar inductance, but provided the value of those to be compared is roughly the same, the absorption method (which was discussed in this journal some time ago) can be depended upon implicitly, provided the test is made with reasonable care. To make a comparison, practically no apparatus is needed beyond a reactive receiver, with a milliammeter in series with its detector anode circuit. The circuit "set-up" for the test is shown in Fig. 2. All apparatus prior to the detector grid circuit is disconnected, and a coupling coil of three turns or so is placed in inductive relationship with the existing grid winding in such a way that its position may ultimately be fixed. This coupling coil is joined in series with the coil under test, and a tuning condenser.

As the next step, the receiver detector valve is made to oscillate gently at a frequency roughly in the middle of the band for which the coil to be tested is intended, and then coupling is set experimentally at a value that will give a small but definite deflection of the milliammeter needle as the test circuit is tuned through resonance.

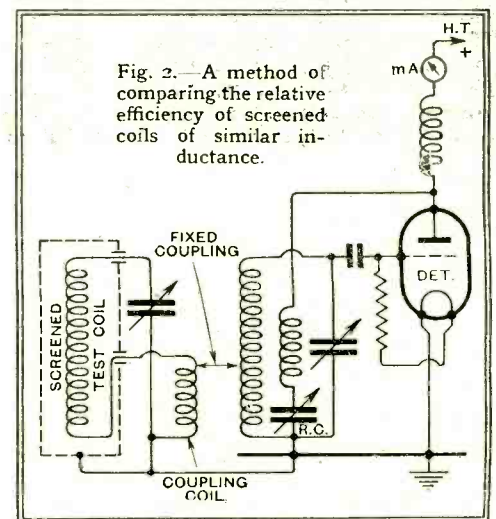

Fig. 2.—A method of comparing the relative efficiency of screened coils of similar inductance.

Other coils may now be substituted, and it may be assumed that the one which gives the greatest deflection of the milliammeter is the best. While making comparisons, the relationship between the coupling coil and the receiver grid coil must remain unchanged, and it is also worth while to take care that connecting leads are not disturbed.

It is also necessary that coupling should never be so tight that detector circuit oscillations are stopped entirely by the absorption effect. If they are, there is the possibility that two coils of widely different efficiency may appear to be identical.

The Wireless World

A
PRACTICAL RADIO
JOURNAL
22nd Year of Publication

No. 682.

FRIDAY, SEPTEMBER 23RD, 1932.

VOL. XXXI. No. 12.

Editor:

HUGH S. POCOCK.

Proprietors: ILIFFE & SONS LTD.

Editorial Offices:

116-117, FLEET STREET, LONDON, E.C.4.

Editorial Telephone: City 9472 (5 lines).

Advertising and Publishing Offices:

DORSET HOUSE, TUDOR STREET,
LONDON, E.C.4.

Telephone: City 2846 (15 lines).
Telegrams: "Ethaworld, Fleet, London."

COVENTRY: Hertford Street.

Telegrams: "Cyclist, Coventry." Telephone: 5210 Coventry.

BIRMINGHAM:

Guildhall Buildings, Navigation Street, 2.

Telegrams: "Autopress, Birmingham." Telephone: 2970 Midland (3 lines).

MANCHESTER: 260, Deansgate.

Telegrams: "Iliffe, Manchester." Telephone: Blackfriars 4412 (4 lines).

GLASGOW: 26B, Renfield Street, C.2.

Telegrams: "Iliffe, Glasgow." Telephone: Central 4857.

PUBLISHED WEEKLY. ENTERED AS SECOND
CLASS MATTER AT NEW YORK, N.Y.

Subscription Rates:

Home, £1 1s. 8d.; Canada, £1 1s. 8d.; other
countries abroad, £1 3s. 10d. per annum.

As many of the circuits and apparatus described in these pages are covered by patents, readers are advised, before making use of them, to satisfy themselves that they would not be infringing patents.

CONTENTS.

	Page
<i>Editorial Comment</i>	289
<i>Automatic Gain Control</i>	290
<i>The Record—and the Future</i>	293
<i>Practical Hints and Tips</i>	294
<i>Unbiased</i>	296
BROADCASTING STATIONS	
<i>ABROAD, pp. I—II</i>	
PROGRAMMES FROM	
<i>ABROAD, pp. III—XXIII</i>	
<i>Broadcast Brevities</i>	297
<i>Two Speakers from One Set</i>	298
<i>News of the Week</i>	301
<i>Laboratory Tests</i>	303
<i>Standard Battery Co.'s Futura Six</i>	304
<i>Readers' Problems</i>	306

EDITORIAL COMMENT.

Interference Hunting.

A Practical Scheme Suggested.

INTERFERENCE with wireless reception by local electrical disturbances appears to be steadily increasing in intensity, and yet no really serious effort is being made to tackle the problem and suppress the trouble. All that is being done is in the direction of educating those responsible for causing it and hoping that they will be considerate enough to take steps to effect a remedy.

We feel very strongly that this is not good enough and that the listening public is entitled to expect that interference of this kind, which is in nearly every case avoidable, should be more seriously tackled by the authorities.

Success in Germany.

In Germany a large measure of success has been attained through the activities of semi-official groups of individuals who gladly undertook to give their services in trying to trace various forms of interference and to indicate the suitable steps to be taken to remedy it when the offending apparatus has been located. These groups of individual searchers had no authority, of course, to insist upon the elimination of the interference, but in most cases they found the owners of the radiating electrical equipment ready enough to co-operate.

Indeed, the work of the "Radio-Aid" organisation, as it was called, was so successful in clearing the ether of local electrical disturbance that the German Post Office recently took over the service from the amateurs, adopting practically similar methods. Germany is therefore likely to lead other European countries, in the near future, in the possession of a really "free ether."

We suggest that an endeavour such as this is a most worthy object and one which should commend itself especially to the attention of wireless societies throughout the country. It is of no avail to start such a task unless adequate support and interest in it is forthcoming from such a nucleus of an organisation as the radio societies would provide. It is not, of course, necessary that existing societies alone should shoulder the task.

A New Organisation.

Where groups of two or three enthusiastic wireless amateurs exist in any particular locality the work in view is sufficient to interest them in the formation of a special group to undertake this work. The purpose of this note, then, is to feel the pulse of the amateurs of the country to see how much interest would be aroused in this scheme if *The Wireless World* undertook to organise and support it. Details of the equipment necessary for interference tracking would be described and suggestions given for organising and compiling results. Instances of interference traced and cured could be published for the guidance of others, and special attention would be given to cases of particular difficulty. Where owners of interfering electrical plant refused to co-operate, such cases would be referred to us, in order that we might endeavour to bring special pressure to bear in individual instances, if the facts justified such action.

Let us, then, hear from those who are interested in co-operating and the result of this appeal will decide if such a scheme can be launched with prospects of success.

All communications should be sent to *The Wireless World*, marked "Interference Search."

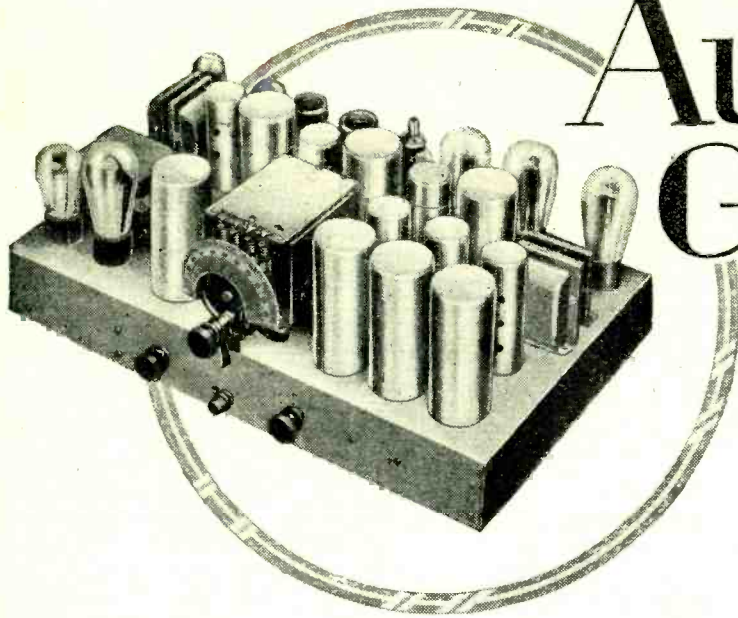

Automatic Gain Control

Part I.—Methods Adopted in America's New Sets.

By A. DINSDALE.

THE latest types of broadcast receiver just now being placed upon the American market by the leading set manufacturers are equipped with what is known in the United States as Automatic Volume Control (AVC, for short). This feature does not supplant the usual manual volume control, but rather supplements it. Automatic volume control may be defined as a device or system which, when the manual volume control is adjusted to give comfortable volume on a distant station, acts in such a way that when the receiver is retuned to a powerful local station the volume of sound emitted by the loud speaker remains the same without readjustment of the manual control.

The AVC systems in use are many and varied, but the principle of all of them is essentially the same; the desired end is achieved by causing the incoming signal itself to control the sensitivity of one or more of the H.F. valves—the more the better. Since an engineer measures the effectiveness of an amplifier (H.F. or L.F.) in terms of the "gain" or amplification per stage, it would perhaps be better engineering terminology, and less confusing all round, to refer to such a system as an automatic *gain* control (AGC).

Special AGC Valve.

To be even more strictly accurate from an engineering standpoint, the system might better be described as *delayed* AGC. Obviously, if the circuits are so arranged that the system commences to operate immediately the weakest signal strikes the aerial, the gain of the H.F. stages will immediately commence to be reduced, and the signal will be lost. In the ideal system the action should be zero until a certain signal strength has been reached, after which the effective action should increase rapidly to prevent the detector-input voltage from rising beyond a predetermined value.

The principle under which current American AGC systems operate is based on the fact that when an H.F. voltage is

applied to the grid of a valve adjusted to act as a detector its average anode current changes. This causes a D.C.-voltage drop across a series resistance, and when

A LARGE number of the new season's sets in America contain automatic volume control, the circuit details of which are given in this article. Special reference is made to the Wunderlich valve, which has helped considerably to simplify design. When signal inputs range, as they do, from five to one million microvolts, it is claimed that some automatic control is advisable. At any rate, in a country where valves are three to four shillings each, automatic gain control becomes only a small detail of design which hardly increases the price of the receiver.

the D.C. voltage is fed back to bias the grids of the H.F. valves the gain of these stages is controlled over wide limits. The control valve may be an additional valve with its grid connected in parallel with the detector grid, or it may be the detector valve itself with certain connections. However, the latter method usually results in lowered sensitivity and is difficult to adjust. When a separate control valve is used the adjustments are simple and can be worked out without greatly affecting detection.

To illustrate the principle and provide a practical example, the circuit shown in Fig. 1 is given. The circuit constants necessarily depend upon the type of valve employed, which in this case is a 227.

The values are R_1 , 1 megohm; R_2 , 0.5 megohm; R_3 , 600 ohms; R_4 , 7,500 ohms; R_5 , 400 ohms; R_6 , 1,500-ohm potentiometer; C_1 , 0.00005 mfd.; C_2 , 0.5 mfd.; C_3 , 0.5 mfd.

The connection D goes to the grid of the detector, and E goes direct to the grids of all preceding H.F. valves. In a super-

heterodyne even the grid of the first detector is supplied with bias from the control valve, unless the first detector is also the oscillator. Best results are obtained if the receiver has a high H.F. gain and low L.F. gain, as in such a receiver a strong signal is found on the detector grid and furnishes a good controlling factor. Also, such a receiver has several H.F. stages, and multiplies the controlling effect in each stage. Any number of stages can be controlled, but if the response is too delicate the last H.F. stage can be built with constant bias.

If the Fig. 1 combination is being added to an existing set, the control valve should be mounted close to the detector valve and the resistances and condensers mounted in any convenient position for making connection to the power-supply voltage divider and to the H.F. grids. Care should be taken to see that all H.F. cathodes are earthed, and that the earth lead is attached to the power-supply voltage divider at the point A—not at the

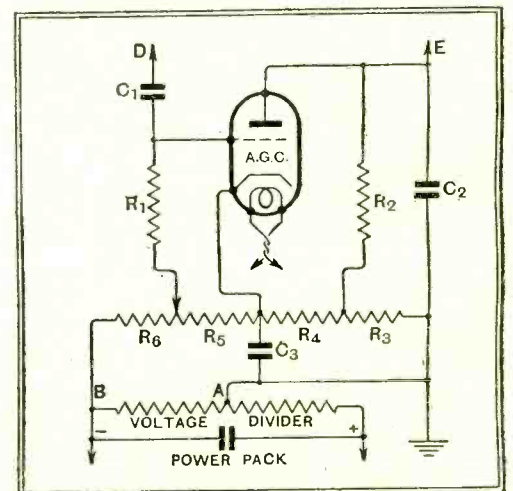

Fig. 1.—The essential circuit details of a separate automatic gain control valve.

negative end B. The potentiometer R_6 should be mounted on the receiver panel, for the final output volume is controlled by means of it.

An important feature of AGC systems

Automatic Gain Control.—

is the speed at which they respond, and this speed can be adjusted from one-twentieth of a second up to several seconds. If the circuit is designed for slow-speed response it is possible to tune the receiver from one powerful local station to another equally powerful local in silence. With a circuit adjusted for high-speed response the intermediate space between tuning adjustments is filled with background noise as the H.F. gain immediately jumps to maximum sensitivity. However, "noise suppressors" can be applied very simply to reduce this, and

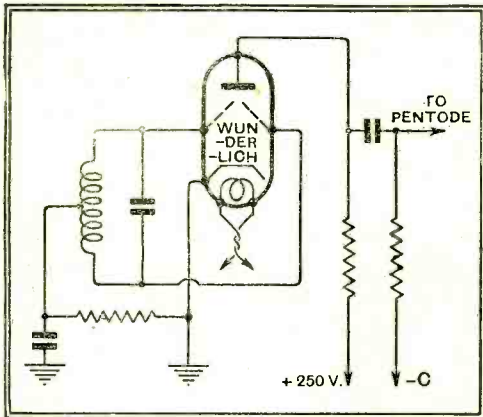

Fig. 2.—The fundamental detection circuit for the Wunderlich valve.

the received signal may fade very severely.

With some high-magnification receivers the sensitivity is too great for many American locations, especially in cities where the background noise due to man-made static is heavy. Under such circumstances, with AGC in full control, tuning from one station to another would be a noisy business as the sensitivity of the receiver suddenly rose between stations. To overcome this, and give background-free reception of distant stations, a "noise suppressor" is fitted. This is simplicity itself, being merely a switch and a variable resistance which permits the fixed control grid bias of the first I.F. valve to be increased. The resistance merely increases the current through the permanent bias resistance of the first I.F. valve to the required degree. By means of this arrangement all noise, and signals, below 80 microvolts absolute are cut out completely. The noise suppressor can be switched in or out, according to conditions and requirements.

Another very simple system of AGC which is rapidly becoming popular in America depends for its success upon a special valve known as the Wunderlich valve. For the following information and circuit data concerning it I am indebted to the inventor, Norman E. Wunderlich, of Chicago.

Full-wave Detection.

The valve itself may be visualised as a triode to which has been added a second grid that is wound between the meshes of the usual grid, the capacity and impedance between each grid and the earthed cathode being balanced. The valve has been developed for grid-leak power detection purposes, and gives full-wave rectification in a balanced circuit (push-pull) in which negligible H.F. current flows in the anode circuit. The accompanying photograph shows the electrode structure.

It is claimed that this is the first modern valve designed specifically for detection, a function to which valves originally intended for amplification have hitherto been applied, usually with indifferent success. The new valve may be regarded as a perfected "grid" detector. With it, the full benefits of grid detection may be realised without the limitations heretofore characterising this form of detection. It has long been recognised that grid detection gives reproduction decidedly superior to anode bend detection, but the relatively low outputs of previous forms of grid detectors have limited their utility.

In addition to acting as a detector, the Wunderlich valve supplies the necessary voltage for AGC, and, by a circuit arrangement somewhat reminiscent of the reflex circuits of bygone years, provides a first stage of L.F. amplification with sufficient output to feed two power valves in push-pull. The automatic bias is obtained from the rectified carrier and is not appreciably related to percentage of modulation or noise level. The varying bias in relation to the incoming and detected carrier prescribes a curve which practically corre-

sponds with the dynamic characteristics of the variable- μ valves which it is controlling. In this way the voltage at the detector input is always held at the one level where best demodulation is secured.

The fundamental circuit for the valve is given in Fig. 2, from which it will be seen that full-wave rectification is obtained by applying the incoming signal between the two grids, with a centre tap from the in-

ductance of the tuned circuit made to the cathode through the grid leak and grid condenser combination. By drawing this input circuit separately as in Fig. 3, it is seen that the arrangement is exactly the same as the full-wave, centre-tapped rectifier circuit commonly employed in H.T. eliminator systems, with the grid-leak-condenser combination representing the load impedance to which the rectifier current is delivered. The voltage which the rectified current develops across the leak-condenser combination is then applied to the two grids in the same phase, and so is amplified in the plate circuit by ordinary L.F. amplifier action, considering the Wunder-

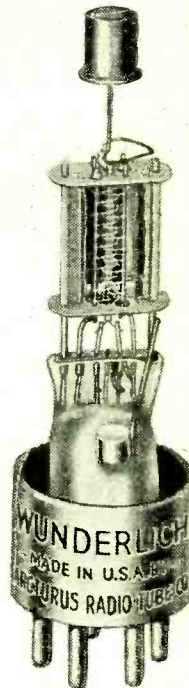

The electrode construction of the Wunderlich valve.

lich valve to be a triode in which the grid is formed by the two grids connected in parallel.

When the circuit of Fig. 2 is employed there will be a negligible amount of high-frequency energy flowing in the anode circuit. This is because the high-frequency voltages applied to the two grids are of equal magnitude but opposite phase, and hence neutralise each other as far as any

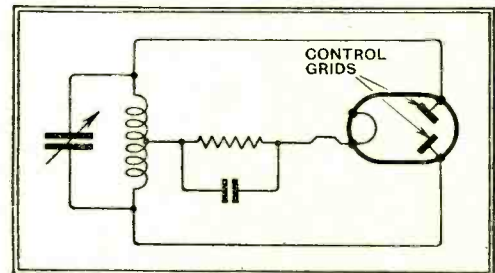

Fig. 3.—By redrawing the circuit of Fig. 2 the similarity of the Wunderlich circuit to that of a mains rectifying valve can at once be seen.

effect on the anode current is concerned. This balanced input feature has two very important advantages: (1) it approximately doubles the available output voltage by eliminating all possibility of simultaneous anode and grid rectification, and (2) it makes unnecessary the usual H.F. filter (choke) in the anode circuit of the detector.

An important point is that, since stronger carriers only serve to produce

for general purposes a high-speed response is much to be preferred, for it must not be forgotten that AGC very largely permits fading to be overcome, and the higher the speed-response of the AGC the more effective it will be in combating high-speed fading. This is a point which perhaps has more value to European than to American listeners. So-called "DX" hunting is no longer popular in America, and the principal advantage to American listeners of AGC is the ability to tune in the up-to-several-dozen high-power stations which may be available within a 100-mile radius without altering the adjustment of the manual volume control. Thus, it is at present more of a luxury than an important necessity.

The Noise Suppressor.

Referring again to Fig. 1, the speed of response depends upon the values of R_2 and C_2 , or, rather, on their product. The larger their product the slower the response of the circuit, because a large condenser holds its charge a long time, and a high resistance across it discharges it slowly.

In practice the connection A of Fig. 1 is set at about 25 volts positive with respect to B; the potentiometer, R_6 , is set in a central position, and the value of R_2 is selected to produce a normal bias voltage on the H.F. valves with no signal tuned in. Then C_2 is selected to produce the desired speed of response. The control knob of R_6 serves as a manual adjustment of the volume level, and is operated in the same manner as an ordinary volume control. The AGC system then holds the volume at the level set on R_6 , even though

Automatic Gain Control.—

larger rectified voltages, and, therefore, larger AGC bias for the H.F. valves, a constant level is maintained at the detector input, and the detector cannot normally be overloaded. This governor action is very desirable because turning the manual volume control "up" does not produce a terrifying overload action.

Since the plate circuit of the detector does not carry H.F. energy, whistles (known in America as "Birdies") in the I.F. amplifier of a superheterodyne are reduced, and the entire filter problem is simplified.

When the grid leak and grid condenser are properly proportioned the voltage developed across them by the rectified grid current is almost exactly proportional to the amplitude of the R.F. signal, and hence is a faithful reproduction of the modulation envelope. The voltage across the leak-condenser combination, therefore, consists of a D.C. component proportional to the carrier amplitude, and an A.C. component that varies with the signal modulated upon the carrier. The D.C. component places a negative bias upon the grids, which is the correct polarity for AGC purposes. The A.C. modulation voltage is superimposed on this bias, and is amplified as in a resistance-coupled L.F. amplifier stage, as already explained.

Inasmuch as this A.C. modulation voltage is present across the grid leak, in addition to the D.C. bias, it is necessary to employ some type of filter to prevent the AGC bias from varying with the modulation of the carrier wave. A simple method of doing this is shown in Fig. 4. The condenser C should have sufficient capacity to

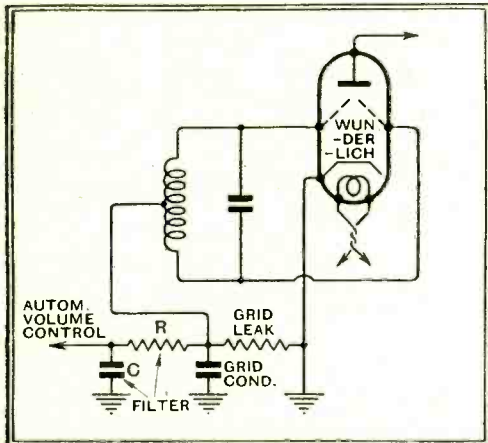

Fig. 4.—The filter circuit for separating the D.C. bias voltage from the A.C. modulation voltage.

be a virtual short-circuit to all modulation-frequency voltages when compared with the resistance R, but should at the same time have a leakage resistance much higher than R. The resistance R should also be at least several times as great as the grid leak resistance if the rectifying efficiency is not to be lowered. The amount of negative D.C. voltage available for AGC purposes depends upon the way in which the anode circuit is arranged, and in the case of the Wunderlich valve can be of the order of 15 volts if desired.

(To be concluded.)

IN NEXT WEEK'S ISSUE—

The Diode Quality Four

A Straightforward and Economical Battery-fed Set with Distortionless Detection.

ON grounds of economy, the modern power grid detector is virtually ruled out for a battery-operated receiver by its heavy anode-current consumption. The diode, on the other hand, consumes no current whatever from the H.T. battery and from some aspects is an even better detector. In its latest form, this system of detection is quite free from the original drawbacks, and the sole disadvantage—the necessity for an extra valve—is amply compensated for in other directions.

Though primarily designed as a "quality" receiver, the new set is amply selective and sensitive for long-distance reception. The basic circuit arrangement comprises an

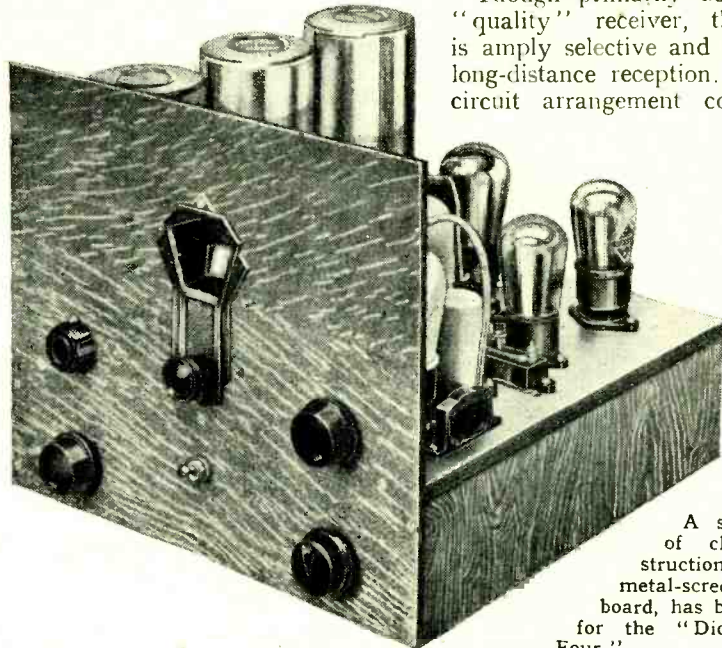

A simple form of chassis construction, with a metal-screened baseboard, has been adopted for the "Diode Quality Four."

input filter, variable-mu H.F. valve amplifier, diode detector, intermediate L.F. stage, and a three-electrode output valve. The usual input volume control is fitted, and, in order that the diode may be operated under the correct conditions, there is also provision for the regulation of L.F. magnification.

As the H.F. circuits are planned to give the maximum sensitivity and selectivity, a small amount of high-note loss takes place, but audible attenuation of the higher musical frequencies is prevented by the inclusion of an adjustable tone control. Not only does this compensate for lost modulation sidebands, but it allows pitch to be adjusted to suit the nature of the transmission and the characteristics of the loud speaker.

LIST OF PARTS REQUIRED.

After the particular make of component used in the original model, suitable alternative products are given in some instances.

- | | |
|--|---|
| 1 3-gang condenser, 0.0005 mfd. (J.B. "Nugang" No. 2054) | 1 H.F. choke (Lewcos No. 11) |
| 1 Disc drive for above (J.B. No. 2052) | 1 Potentiometer, 0.25 megohm (Wearite Q.21) |
| 1 Set of 3 screened coils (Tunewell; A1, A2, G1) | 1 Potentiometer, 25,000 ohms (Wearite Q.34) |
| British General, Colvern, Formo, Lissen, Telsen, Wearite. | 2 Semi-variable condensers, 0.0001 mfd. (Formo Type F) |
| 1 4-pin valve holders for chassis mounting (W.B. Skeleton type) | Polar, R.I., Telsen. |
| Bulgin, Clix, Eddystone. | 1 On-off switch (Igranic "Midget") |
| 1 Resistor, 500 ohms, 1 watt (Claude Lyons) | Bulgin, Claude Lyons, Radiophone. |
| 2 Resistors, 1,000 ohms, 1 watt (Claude Lyons) | 2 Twin plug supports, aerial, earth, loud speaker (Bulgin P.30) |
| 1 Resistor, 5,000 ohms, 1 watt (Claude Lyons) | Belling-Lee, Goltone, Junit, Lissen. |
| 2 Resistors, 50,000 ohms, 1 watt (Claude Lyons) | 1 Battery cable, 5-way (Bulgin B.C.3) |
| Bulgin, Colvern, Dubilier, Loewe, Sovereign, Varley, Watmel. | Belling-Lee, Harbros, Lewcos, Concord. |
| 1 Tone-control transformer with potentiometer (Multitone 4 : 1) | 2 Fixed condensers, 0.0002 mfd. (Telsen No. 241) |
| Varley "Rectatone." | 1 Fixed condenser, 0.0003 mfd. (Telsen No. 242) |
| 1 Fixed condenser, 0.05 mfd., non-inductive (Dubilier Type No. 9200) | Dubilier, Formo, Graham Farish, T.C.C. |
| 2 Fixed condensers, 0.1 mfd. (Formo Type 34C) | 1 Baseboard, 12in. x 12in. |
| 2 Fixed condensers, 2 mids. (Formo Type 38C) | 1 Sheet Metallic Paper. (C.A.C. "Konduclite") |
| 1 Fixed condenser, 0.5 mfd. (Formo Type 36C) | 1 Length screened sleeving (Goltone) |
| Dubilier, Ferranti, Peak, Savage, T.C.C., Telsen. | 6 yds. connecting wire (Concord "Slipquik") |
| 2 H.F. chokes, screened (Wearite H.F.P.) | Harbros, Lewcos. |
| | Screws, wool, etc. |
| | Valves: 1 Cossor 220 V.S.G.; 1 Mullard PM1 H.L.; 1 Cossor 210 L.F.; 1 Mullard PM2A (or PM202); or types of other make with similar characteristics. |
| | Approximate cost, less valves and cabinet: £6 17s. 6d. |

The Record—and the Future.

AT the present time the purchase of a gramophone record is not, apart from its subject, a matter of choice, personal preference, or even experiment.

The familiar black disc with its distinguishing label is the only thing known as a "record" in the popular sense and on the market, and with it the hopes and endeavours of the gramophone enthusiast must begin and end. It is, as it were, his cloth, and, whatever particular pattern or fashion he may prefer, he must, nevertheless, cut his coat according to it.

Steel Tape or Paper Sound Reels?

But what would be our thoughts if, one fine day, we went to the record shop and, on asking for a record, we were to receive, not the familiar object, but a speech like this, from a salesman:—

"Hungarian Rhapsody? Yes, sir; which do you prefer—cylinder or disc (hill and dale, or transverse), steel tape, or sound on film (variable density, or variable area), 'silent background,' or standard?—I'm afraid that's all we have in at present, but we hope to have the new paper sound reels in shortly—yes, sir, variable resistance, you know. . . ."

It would be a bit of a shock, wouldn't it?—and what a shock for the poor record dealer!—but *what* a delight of pros and cons!—Almost as interesting as choosing a new receiver—"Two H.F., one H.F., power-grid-diode-push-pull"—and so on.

As things are at present there is, I'm afraid, more possibility than probability in the above forecast of what may be; but it may serve to bring to the reader's mind a few of the many interesting problems which arise when the question of records and recording becomes something more than "shove a record on"—a heresy of which surely no reader of *The Wireless World* could be guilty!

A Deadly Whisper.

The recording of sound, and its subsequent reproduction by electrical means, has so advanced during the last few years, both technically and artistically, as to take its place in the interest of experimenters by the side of wireless reception, and, indeed, in many instruments designed to serve the dual purpose, shares the whole of the set, from the detector onwards.

But are we tending rather to stagnate in the matter? Are we apt to become too satisfied with our conventional combination of pick-up and amplifier? Does the

General Impressions of a Reader.

By NORMAN P. SLADE.

devil of complacency whisper too often, "That's good, that's splendid; you can't improve on that!?" I only know that I have been listening to this deadly whisper for a very long time, but I still manage to take a firm grip on myself and say, "You *can* do better; it *can* be improved"—and so worth while has this attitude been that I actually say to myself still: "That's good!—oh, that's perfect! You can't . . . !" and off we go again!

Technical Questions.

Unfortunately one's activities are very much restricted by the commercial side of the business. Very much more so than, for instance, in the case of wireless-receiver design; but whatever expansion may occur in the future the existing possibilities, in spite of their limitations, offer an attractively wide field. Thus we find ourselves having to answer such questions as "which pick-up to use? High impedance or low; medium cut-off or high cut-off; compensating or not compensating? What of the weight? Setting of tone arm? Steel or fibre needles? High-resistance potentiometer or low?—What of filters, 'peak adjusters'—tone compensating?" So on and so forth, with all the other questions relating to the amplifier and speaker still to be considered.

Indeed, the field is wide enough, as far as different devices with the same general principle go, to compete with most people's pockets, and win! The really interesting and instructive side of the matter lies not so much in a mere comparison of standard productions, but, as in the earlier days of wireless (when we weren't ashamed of actually making a rheostat for ourselves!), of seeing to what extent these standard productions may be adjusted and adapted to give improved results, and of making experiments towards perfection within the limiting factors of the whole process. One would, of course, wish to go farther, and say "towards *overcoming* the limiting factors," but, unfortunately, making a pick-up is a very different matter from



winding a coil, and making a record from buying one; wherefore this side of the business is more in the well-equipped manufacturer's province than ours. But there is always the question of design—always the room for well-thought-out ideas, and in this sphere there seems to be no reason why the amateur should be any less indifferent, or less effective, than he has been in the field of wireless research.

It is just such a spirit, and such enterprise, that *The Wireless World* has always been pre-eminent in fostering, and we all know that we may look to it with the same confidence and expectation in the newer field of sound recording as we have come to do in the more familiar one of wireless reception. For, though primarily devoted to the reproduction of "sound on ether," it has always shown itself keenly alive to the problems connected with sound on more material media, and future issues will show that this interest is in no wise diminishing.

Great Possibilities.

To emphasise the importance of "canned sound" is obviously superfluous, but to emphasise the possibilities of other modes of canning, and, to maintain the ugly metaphor, of "can-opening" may not be out of place now that the universal disc reigns supreme. Into the technical advantages and disadvantages, excellences and shortcomings, it is not for this note to go; it is hoped rather that the reader's mind may, perhaps, be stimulated to consider the vastness of the possibilities, and to look forward with keener anticipation to technical developments which may take place in the future.

Next Week's Set Review:—

**THE H.M.V. SUPERHET
PORTABLE SIX.**

HINTS and TIPS.

IT is almost inevitable that much of the metal-work of a D.C. mains receiver should be "live," consequently the cautious constructor of a set of this type will always take care to see that proper protection against shock is afforded by the cabinet. In many cases the spindles of control devices—not excluding tuning condensers—will be at a relatively high voltage with respect to earth, and so with respect to the hand of the user. It is therefore worth while to see that the grub screws which secure the control knobs to their spindles are deeply countersunk, so that there is no risk of making contact with them. If necessary, the screws may be reduced in length, but as a rule it is as well to make sure they are left with a sharp point which will bite into the metal of the spindle and so prevent slip.

Shocks from D.C. Sets.

IT should not be forgotten that almost every popular method of variable tone correction involves a loss in the average level of amplification. In other words, one end of the frequency scale is attenuated by operation of the control, while the other remains sensibly unchanged. This means that tone correction, at any rate if it is to be drastically applied, is rather out of place in receivers which lack a considerable margin of amplification over and above that necessary for full-volume reproduction. In practice, therefore, when extensive correction is to be employed to compensate for a deficiency in some parts of the receiver, it is often necessary to add

The Cost of Tone Correction.

another stage of amplification, but occasionally sufficient reserve is obtainable by substituting, say, a transformer for resistance-capacity coupling, or even by using

PRACTICAL AIDS TO BETTER RECEPTION.



a transformer with a higher step-up ratio than would be normally employed. That the latter alternative almost always involves some sacrifice of bass is not always a bar to its usefulness; as often as not, tone correction is included with the main object of restricting response in the lower register.

THERE is little point in under-running an eliminator, and users of these devices should not rest content with the volume of loud speaker reproduction with which they were forced to satisfy themselves when H.T. batteries were employed. Even the cheapest and simplest of eliminators gives a greater current than can be economically drawn from dry batteries, and so the substitution of an output valve of higher power is clearly indicated when an eliminator is first fitted.

Loading the Eliminator.

Even if it is decided that the existing output valve be "run to death," a different type should generally be chosen as a replacement becomes necessary. The guiding principle in choosing a substitute should be to employ the valve with the greatest undistorted output, but still to keep within the rating of the eliminator.

greatest amount of current will almost invariably give the greatest undistorted output.

THE complete circuit diagram of a modern receiver may, at first sight, appear to be so complex as to require a distinct mental effort to master its intricacies. For this state of affairs the blame, if blame there be, must be apportioned to the tendency to add refinements which were almost unknown—and certainly quite unnecessary—in sets suitable for the much-less-exacting conditions of a few years ago.

As the ability to read circuit diagrams is absolutely essential for a proper understanding of any technical radio topic, attempts are often made, when preparing diagrams for publication, to simplify the subject by omitting all non-essentials, or, at any rate, those details which do not affect the point at issue. Fortunately, these efforts seem to be fairly successful, but it is not unknown for the aim to defeat its own object; readers sometimes find difficulty in determining precisely what has been omitted.

Uncertainty on this score may best be dispelled by giving an example of what constitutes the conventional "skeleton diagram." It is hardly correct to say that nothing but essentials are shown in such diagrams; for instance, L.T. heating connections are never drawn in full, although we all know that a valve cannot operate with a cold filament. Although there is no definite rule in these matters, it is fairly safe to assume that the details omitted are those in which conventional practice is followed, and where there is no scope for originality.

The diagram given in Fig. 1 represents a more or less typical H.F.-det.-L.F. battery set, and it will help to make our present subject clear if we run briefly through the various omissions. Starting at the aerial end, it will be observed that no provision for wave-changing is indicated. But this would be an unnecessary complication; in at least 99 per cent. of modern sets wave-changing is effected in a conventional manner. It will be seen that details of the filter coupling have similarly been left out; it is debatable whether this is really permissible, but they take quite a long time to draw, and from

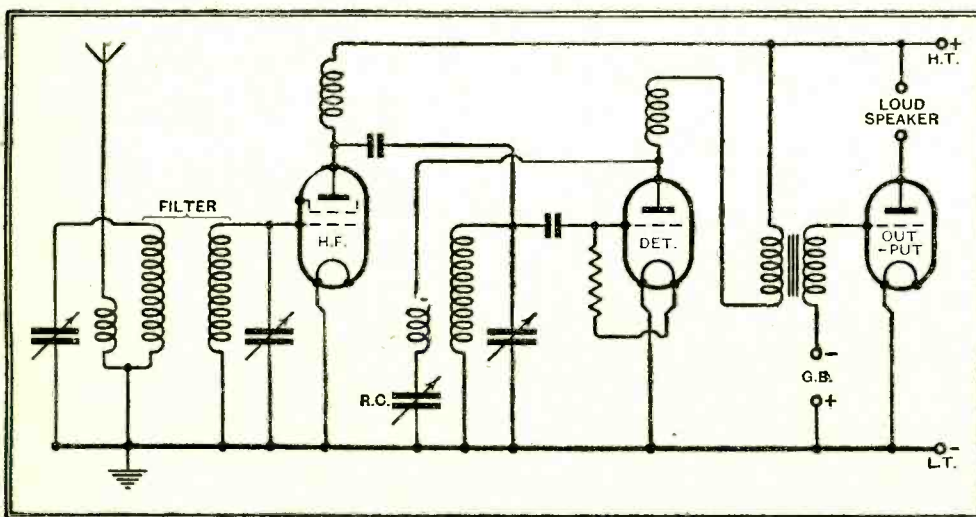

Fig. 1.—Illustrating the usual method of simplifying theoretical diagrams by the omission of non-essentials or of details in which there is an accepted convention as to the circuit arrangement.

another stage of amplification, but occasionally sufficient reserve is obtainable by substituting, say, a transformer for resistance-capacity coupling, or even by using

This is where a publication like *The Wireless World Valve Data Sheet* is invaluable, but, failing this, it may be remembered that the valve which consumes the

Hints and Tips.—

the point of view of a general discussion of the features of a set it matters little how the circuits are coupled so long as they perform their function properly. Grid bias for the H.F. valve is not shown, although in practice it would always be used; perhaps it would be more logical to leave it out also in the case of the output valve, but its inclusion is perhaps instinctive.

voltage feed for the screening grid, H.T. negative connection, and the wave-changing device for the H.F. coupling.

Although this simplified sketch presents, to those who are fortunate enough to have the ability to understand circuit diagrams, a more vivid picture of the essentials of the receiver than would be conveyed by hundreds of words of description, it is obviously not meant to serve as a guide to an uninitiated prospective constructor.

will be worth while to compare it stage by stage with the simplified Fig. 1.

Lastly, a word of explanation should be given with regard to the shading of a part of the diagram. This artifice is quite often adopted nowadays in order to throw into relief any special points that are being discussed. The present diagram, for instance, might be taken as illustrating the additions of a band-pass filter, gramophone pick-up terminals, and

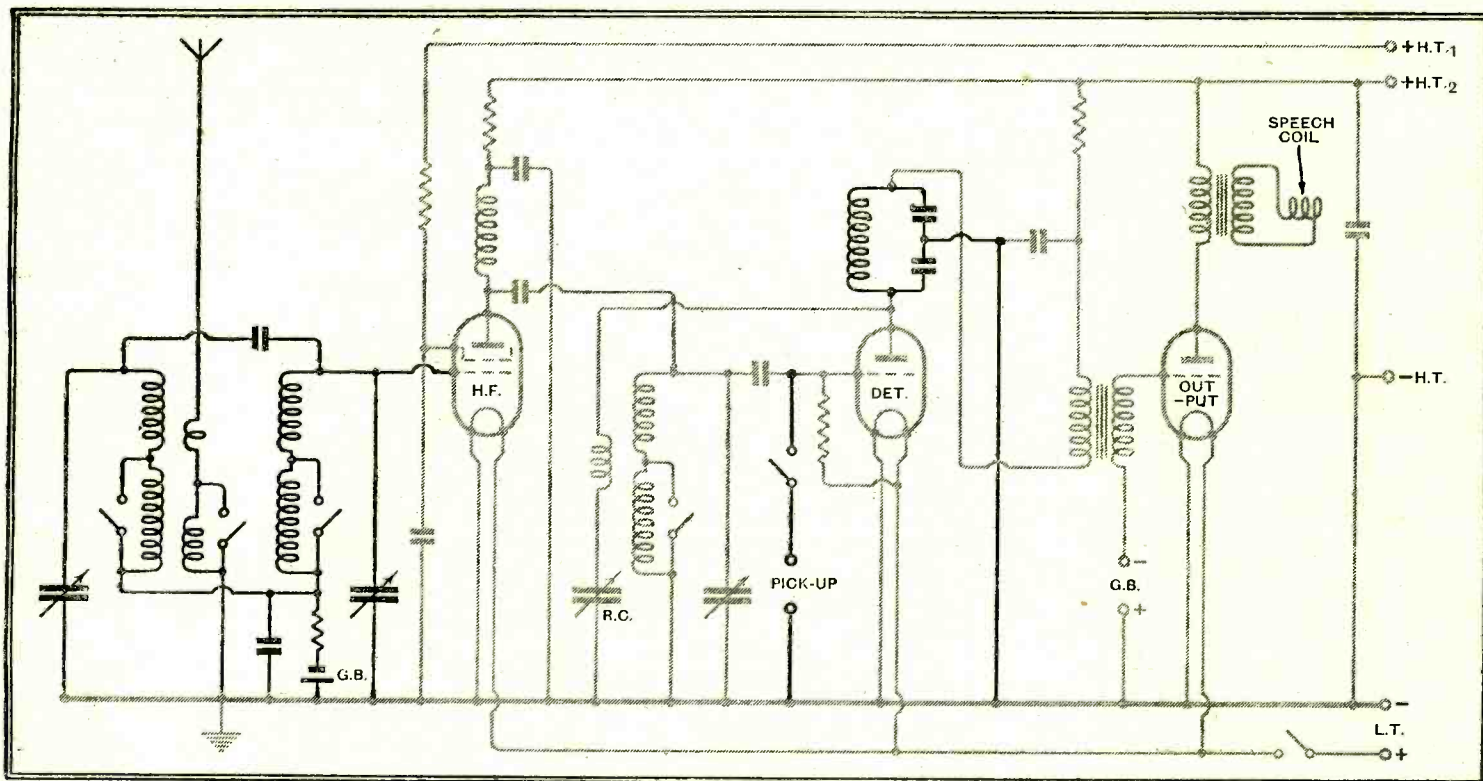

Fig. 2.—The circuit of Fig. 1 in completed form, with elaborations. Shaded lines are used to throw into relief those details which are the subject of discussion.

Diagrams are legitimately simplified by the omission of all decoupling, and, to a lesser extent, of by-pass condensers. This has been done in the present case, and also no attempt has been made to indicate the type of loud speaker employed. Other omissions are the on-off switch,

He would require something much more elaborate, such as the diagram in Fig. 2, which contains all the additions to the skeleton diagram that have been discussed, as well as one or two more.

Ignoring for a moment the fade-out effect given to a part of the diagram, it

an H.F. filter in the detector anode circuit, to a set that is in process of being modernised.

THERE is sometimes a tendency, when choosing a loud speaker, to give great thought to such considerations as frequency characteristics, suitability of the field winding (if any), the output transformer, etc., and to ignore entirely the question of the power-handling capabilities of the instrument.

Power-handling Capabilities.

Some of the smaller speakers are intended by their designers to deal with an input of only 3 watts or so of audio-frequency energy; used with, say, a 6-watt valve, such a loud speaker is anything but satisfactory, and it will be found that full advantage cannot be taken of the output of the valve.

Those who use batteries, or even low-power mains-driven sets, should also bear in mind the question of sensitivity, which is always mentioned in our test reports. An efficient loud speaker operated in conjunction with, say, a 500-milliwatt valve is just as satisfactory as another instrument of equally good characteristics but half the sensitivity, working with a valve giving 1,000 milliwatts.

The Wireless World INFORMATION BUREAU.

Conditions of the Service.

(1) THE service is intended primarily for readers meeting with difficulties in the construction, adjustment, operation, or maintenance of wireless receivers described in *The Wireless World*, or those of commercial design which from time to time are reviewed in the pages of *The Wireless World*. Every endeavour will be made to deal with queries on all wireless matters, provided that they are of such a nature that they can be dealt with satisfactorily in a letter.

(2) Communications should be addressed to *The Wireless World* Information Bureau, Dorset House, Tudor Street, E.C.4, and must be accompanied by a remittance of 5s. to cover the cost of the service. The enquirer's name and address should be written in block letters at the top of all communications.

(3) The fee of 5s. covers the reply to any wireless technical difficulty, but in special cases, where the enquiry may involve a considerable amount of investigation, an increased fee may be necessary. In such cases a special quotation will be made.

(4) Questions should be clearly written and concisely worded in order to avoid delay. Where enquiries relate to trouble experienced in receivers built to specifications in *The Wireless World* a complete account should be given of the trouble, and especially the symptoms.

(5) Where reference is made to published articles or descriptions of apparatus, the title of the article, the date of publication in *The Wireless World*, and the page reference number should be given, in order to facilitate reply.

(6) Full circuit diagrams, constructional details of apparatus, or values of components for home-designed receivers cannot normally be supplied, but circuit diagrams sent in with queries will be checked and criticised.

(7) Particular makes of components cannot, in general, be recommended, but advice will be given as to the suitability of an individual component for a particular purpose specified by the enquirer.

UNBIASED

By FREE GRID.

Straight from the Horse's Mouth.

I SEE that bookmakers have been complaining bitterly concerning the way in which certain B.B.C. announcers pronounce horses' names.

Now, racing people are a law unto themselves concerning this matter, and it is quite impossible for the B.B.C. announcers to attempt to pronounce the names in the manner peculiar to the racing



In the vernacular.

fraternity. The only thing is for the B.B.C. to apply for a pukka racing man to come along to Broadcasting House at 6 o'clock every night to announce the day's results in the vernacular.

Robolympia.

A CORRESPONDENT who has written me rather a meandering letter concerning the great exhibition, in which he discusses various aspects of the show ranging from the robot to the prevalence of high prices in the case of certain valves and sets, has suggested that in future the show should be labelled "Robolympia" rather than the now familiar "Radiolympia." He leaves me completely in the dark, however, as to whether he has in mind the robot and the fact that the whole exhibition is becoming more and more robot-like every year, or whether uppermost in his mind is the question of the high prices charged by certain manufacturers. Perhaps, after all, he intends the word to have a double meaning.

Those Automatic Stops.

AN enormous number of readers seem to have taken an interest in the tests of automatic stops for gramophones which I promised to conduct at the Radio Show, and several readers who carried out tests themselves have sent me interesting accounts of their adventures.

Unfortunately, I am not permitted to mention names, the laws of libel being what they are, but with one or two glaring exceptions these devices were much better

than they were last year. In fact, at three stands I was completely dumbfounded to find that, in spite of the most strenuous efforts on my part, I was totally unable to throw the apparatus out of gear. In other cases, however, I was more successful, and at one particular stand I regret to have to put on record the fact that I met with extreme discourtesy, the details of which I will briefly relate.

The number of people exhibiting these devices was so large that I was compelled to press a couple of the little Grid Leaks into service, the procedure being that in the case of any automatic stops which they could not put out of order I was summoned to tackle it with my own hands. In the case of those which they succeeded in smashing up they did not, of course, bother to call me. There was one exception, in which it was reported to me that the thing seemed to peter out too easily; my curiosity was piqued, and, prodding my way through the crowds with my umbrella, I made my way to the stand in question.

Upon my arrival an indignant-looking female, who appeared to be the wife of the proprietor, was examining the wreckage left by the particular Grid Leak who had tested it. No sooner did we make our appearance than she bore down upon us in awful majesty, like a ship under full canvas, and demanded instant compensation. It was, indeed, with the utmost



She bore down upon us.

difficulty that I extricated myself and my progeny from a particularly difficult situation. Had it not been for a well-timed flanking movement leading to an attack in the rear by the little Grid Leaks, affairs would have gone ill with me. In future, I shall avoid stands upon which a woman is the presiding deity.

A Warning.

THE principles of radio find all sorts of practical applications nowadays, and it did not surprise me to hear that a worthy inhabitant of Egypt had applied them to the devising of an instrument for measuring the amount of moisture in bales of cotton which left Cairo. His device

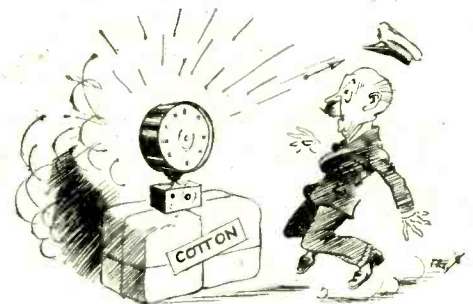

The needle flew off.

was completely successful in the land of the Pharaohs, and so he at once packed his equipment and set out for Manchester in order to interest Lancashire cotton-spinners.

But alas! he had reckoned without our climate, more especially that of the town of brolleys and gum-boots. The instrument began to show violent agitation as soon as it passed the Lancastrian frontier at Stockport, and at the sight of a bale of cotton which had stood in the warehouse at Manchester Docks for a couple of weeks, the needle flew right off the scale.

The damaged instrument is, I understand, to be exhibited at the Manchester Radio Show as a warning to other inventors.

"In a Low State."

I HAVE always considered that the lay Press will swallow a lot of tall stories about the potentialities of wireless and, indeed, my opinion has again and again been confirmed by the "tripe" they dish up, certain examples of which I have been constrained to draw attention to from time to time.

As a rule their efforts are specially brilliant during the run of the Olympia Exhibition, but nothing they have perpetrated in connection with the annual Radio Show has even remotely approached the wild extravagance in which they have indulged in connection with the recent exhibition of model engineering.

After solemnly prophesying that in the near future burglar alarms will be caused to operate by the mere presence of an intruder in a room, and similar things which were accomplished years ago, they tell us with bated breath that they saw two model electric trains start when a man held his hand over a copper plate. Shades of the "Festival of Empire" at the Crystal Palace in the year of "W.W.'s" birth! Cannot they find something more modern than this? But the best is yet to come, and, as my own words fail me, I must quote verbatim: "When the hands are taken away the train stops. That is an effect of the electric radiations of the human body. The power of the instrument increases apparently with concentration of mind. People in good health produce stronger effects than those in a low state."

All I can say is that it is certainly time that daily newspapers considered the addition of a scientific censor to their staff. I am open to consider offers.

Broadcast Brevities.

By Our Special Correspondent.

A Red-letter Day.

OCTOBER 1st, if my information is correct, may make broadcasting history in this country. I hear that on that day—which happens to be a Saturday—a minor earthquake is timed to occur among the staff at Broadcasting House. When the smoke clears, so I am told, we shall see several prominent officials enthroned in new niches.

Adrian Boulton.

A more adequate recognition of Mr. Adrian Boulton's services has already been hinted at in these columns and it will surprise no one if the Director of Music is elevated to the rank of Assistant Controller. But other promotions, I understand, may be looked for, and these in turn should lead to some well-timed transfers of hitherto minor officials to positions of greater trust and responsibility.

Why Not an Annual Shake-up?

Some people may ask whether "domestic" questions of this kind are really worth the attention of the ordinary listener. But are they "domestic"? Rather, I think, we should look upon them as affairs concerning everyone of us who tunes in the B.B.C. programmes in the hope of extracting entertainment and profit.

It is good that these changes should take place, and it would not be a bad plan if a reasonable reshuffling of the B.B.C. personnel took place every autumn.

Rumours.

In the meantime "October 1st" is being uttered with bated breath in Portland Place, where rumours chase each other like the horses on a roundabout.

When Will They Wake Up?

NEWS from Madrid is coming through slowly, possibly for the excellent reason that there is little to report. This is understandable, considering that the delegates wrangled for a whole day on the question of what should be the official language for use in the discussions!

I hear that the long waves are being attacked by the American delegation as unsuitable for broadcasting. Can there be any connection between this hostility and the fact that American commercial receivers do not tune above the medium waveband?

Strange Complaint.

Be this as it may, the Americans have adduced another reason, but I would wager that no reader of *The Wireless World* could guess what it is.

It is simply this: that the European long wave stations cause interference to reception in the United States!

Trick Cyclist at Broadcasting House.

IF you have a television Red Fred will entertain you to-night (Friday) with trick riding and balancing on a single-wheel cycle. Known as "the little marvel on the wheel," Fred is the first trick cyclist to appear in a television turn at Broadcasting House.

Mast-building Feat.

THE welkin is ringing at Watchet over a record construction feat. I hear from Mr. Tudsbury, the B.B.C.'s civil engineer, that the second of the two lattice masts for the West Regional station was shot up in twenty working days. It is 500ft. high.

The new buildings are progressing satisfactorily and when the lid is on, early in November, no time will be lost in installing the first of the heavy plant.

Fears in Plymouth.

It is not surprising that Plymouth listeners are growing agitated at the progress of the new station, fearing that it may supplant their trusty little relay station which has been giving really good service ever since 1923. Fortunately, there is the reassuring news from H.Q. that the Plymouth station is likely to be retained in the same way as those at Aberdeen and Newcastle.

Tests after Dusk.

Plymouth listeners are asking for more programmes of a local character from their transmitter, but here a technical difficulty crops up. It is feared that independent transmissions from Plymouth *after dusk* may cause interference with other B.B.C. stations. Tests are to be carried out.

Not New.

FROM the fuss that is being made about it in the daily Press, one would imagine that the new poetry "Epilogue" which the B.B.C. is introducing on Monday, October 3rd, was an unheard-of innovation in British broadcasting. Have the public forgotten that rather hackneyed Longfellow excerpt with which the unctious B.B.C. of ten years ago used to send us to bed? "And the night shall be filled with music, etc., etc."

"Epilogue."

One fears that the word "Epilogue" now has only one meaning in the minds of the majority of listeners, and it is a pity it was ever associated with the new series.

The Tenth Birthday.

THE week beginning November 13th marks the tenth anniversary of the B.B.C., and plans are now in hand to celebrate the event. In addition to a feature programme comprising a tour of the twenty-two studios at Broadcasting House, listeners will hear a performance of "The Three Musketeers," which is to be divided into two parts to be given on consecutive evenings. A "Music Hall" vaudeville programme and an all-star vaudeville show are to be arranged during the week.

A Travelling Talker.

MR. VERNON BARTLETT'S broadcasts from European capitals during the coming months will give him an opportunity of speaking in an entirely different way from his previous broadcasts, which have, for the most part, taken place from a studio in London. In his new venture he will speak surrounded by the influences of the places he is actually visiting, and his viewpoint for that reason is likely to be somewhat different.

An Unsung Hero.

WITH their split-second methods it is not astonishing that the American broadcasting concerns occasionally make mistakes at the switchboard. A friend tells me of a funny happening the other day when a programme originating in Chicago was passing through the New York headquarters on its way over the network. The programme was a sketch entitled "Unsung Heroes." The time came for New York to cut the Chicago line and provide music to fill the remainder of the period. Somebody pressed the wrong button and switched on to the air a studio in which the piano tuner was prosaically doing his stuff. And this unsung hero never knew that his great moment had arrived!

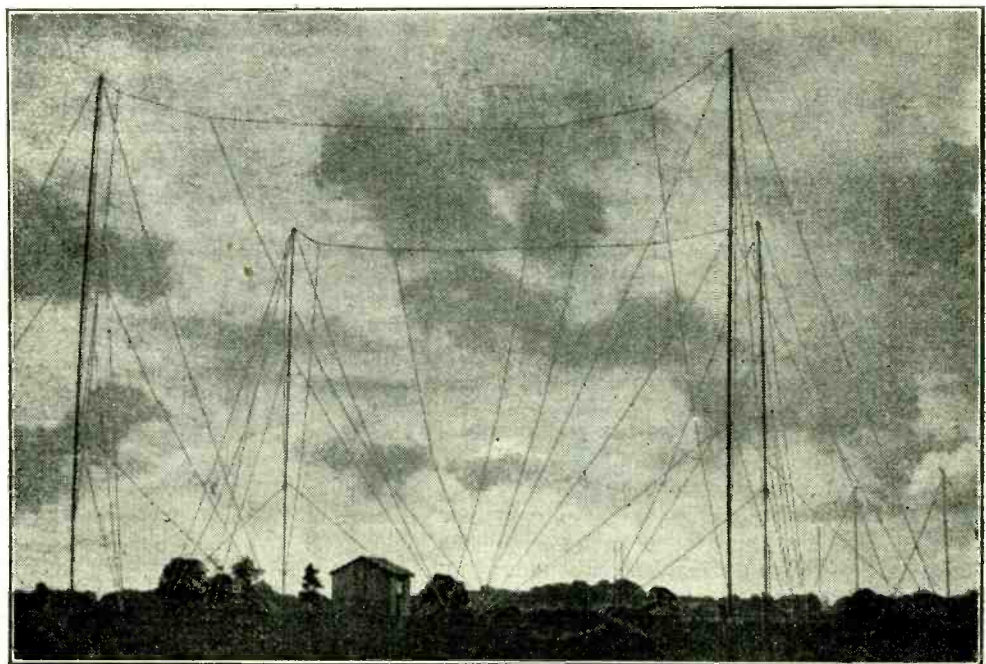

A MYSTERY CLEARED UP. This network of transmitting aerials has sprung up almost in a night in the field adjoining the B.B.C.'s check receiving station at Tatsfield. The system actually comprises an experimental broadcasting station with which the B.B.C. engineers are testing various possible aerials for use when the rebuilt 5XX is installed at Droitwich.

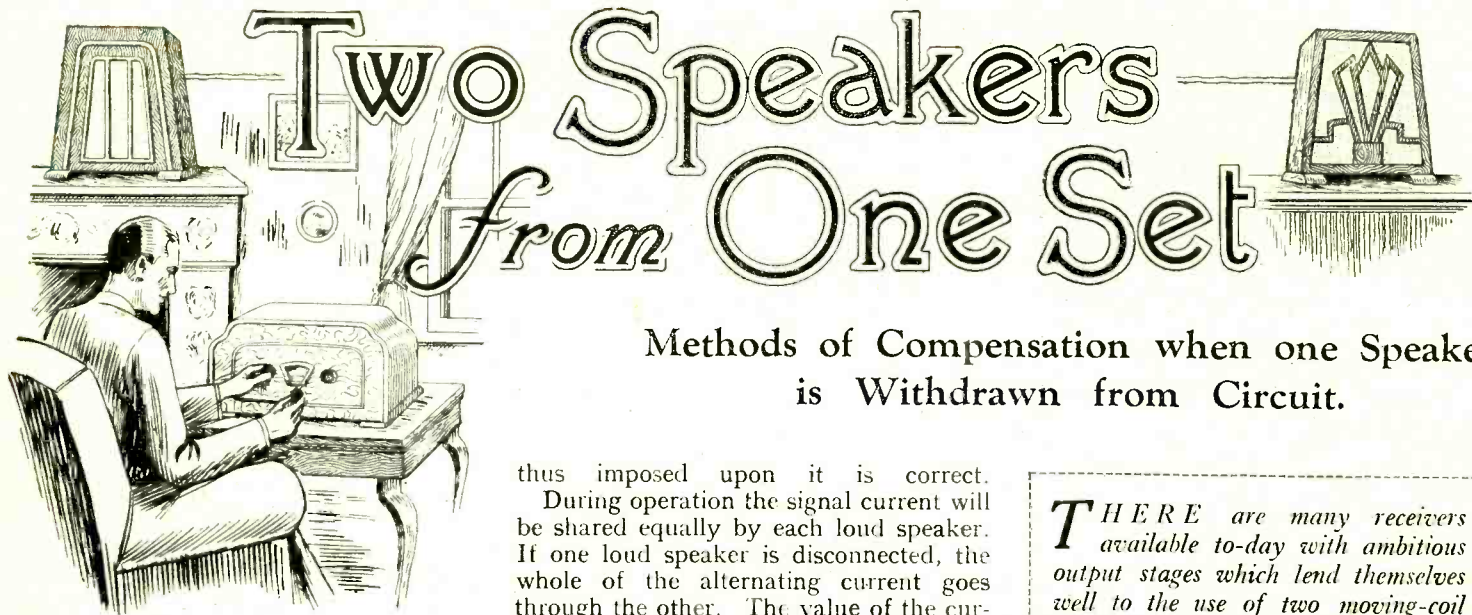

Methods of Compensation when one Speaker is Withdrawn from Circuit.

IN public address systems where more than one loud speaker is operated, the output transformer is usually required to deal with varying circumstances. If the transformer is designed to take two loud speakers and one is suddenly removed, the load conditions alter considerably and affect the output from the remaining loud speaker and sometimes the quality of reproduction. Where, say, five or more loud speakers are worked from the same transformer, the conditions do not alter appreciably when one loud speaker is removed, since the variation in the impedance of the speaker group is only 20 per cent. of the whole, and the influence of this change would not readily be detected by ear. As a concrete instance we may quote the case of the B.B.C. at the National Radio Exhibition. Here the power valves feed some hundreds of loud speakers—which seldom or never sound so well in after life—with a large undistorted input. If a few loud speakers are suddenly removed, the effect on the output system can be disregarded entirely.

Two Speakers in Parallel.

Before specifying any special method of working more than one loud speaker from a receiver, we can profitably enquire into the nature of the problem by starting at the beginning. Taking the elementary case where two loud speakers—assume they are of the moving-coil class—are to be worked from the same transformer secondary, suppose we examine the situation when one speaker is suddenly removed. Referring to Fig. 1, we have the well-known circuit where the steady anode current passes through the transformer primary, although it is preferable to avoid this by using the customary choke-condenser output. The moving-coil loud speakers A and B, these being of identical design, are connected in parallel across the secondary winding of the transformer. We take it for granted, of course, that the transformer is designed in such a way that the load

thus imposed upon it is correct.

During operation the signal current will be shared equally by each loud speaker. If one loud speaker is disconnected, the whole of the alternating current goes through the other. The value of the current through the remaining speaker is now greater than it was before, but it is less than twice the current through each speaker when they were in parallel. There should be no difficulty in appreciating this, because the total circuit impedance is greater with one speaker than with two in parallel. Thus the removal of one speaker causes an increase in output from that which remains in operation. As an approximate figure based on average data, we can take the increase in power to be about 40 per cent. If this loud speaker is operating at a comfortable loudness in a room downstairs, say, the increase in loudness due to the removal of the second speaker may be unpleasant. There is another change which may occur, namely, in the quality of reproduction, and it is desirable to know how we stand here. The actual change in quality depends upon the power valve resistance, the design of the output transformer, and the impedance

THERE are many receivers available to-day with ambitious output stages which lend themselves well to the use of two moving-coil speakers in different parts of the house. So long as the matching of the load impedance has been carried out correctly and both speakers are in circuit, no difficulty arises. But as soon as one speaker is withdrawn from circuit, not only is there a considerable increase in volume from the remaining speaker, but some distortion is introduced. To avoid this, a compensating circuit is necessary, the design of which is described in the accompanying article.

is a weakening of the upper frequencies when only one speaker is used, but it will not be really serious.

D.C. and A.C. Resistance.

The variation in the impedance of a moving-coil speaker is a subject on which little has been written in *The Wireless World* recently, so we shall give a few details showing what is to be expected

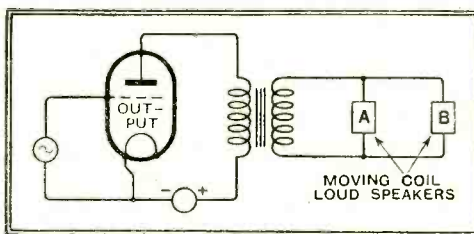
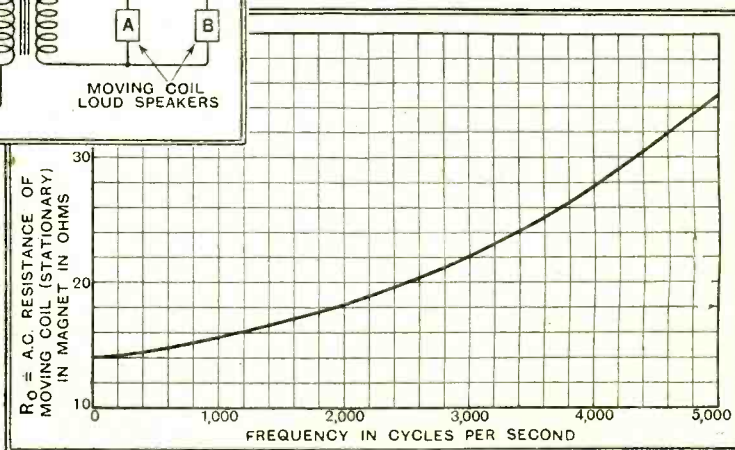

Fig. 1.—Conventional output circuit of power valve transformer coupled to two identical moving-coil loud speakers in parallel.

Fig. 2.—Showing the change with frequency of the A.C. resistance of a stationary moving coil.



of the particular class of speaker used. In general, the resistance of the speaker increases considerably as the frequency rises. This, in company with the reactive drop due to the inductance, means a reduction in signal current. The net result

when the frequency varies from 50 to 5,000 cycles per second.

In Fig. 2 is plotted a curve showing the variation in the resistance of the moving coil of a certain loud speaker. Starting at 50 cycles per second, the alternating

Two Speakers from One Set.

current resistance is practically equal to its direct current value as obtained from the formula: Resistance = $\frac{\text{Volts applied}}{\text{Current in Amperes}}$

As the frequency increases, the resistance rises slowly at first, then more rapidly, until at 5,000 cycles it is two and one-half times its value at 50 cycles. Why should the resistance increase in this manner?

Eddy Current Losses.

When an alternating current of 100 cycles passes through the moving coil it creates an alternating magnetic field, i.e., it changes its polarity 100 times per second. This field passes through the metal of the magnet of the loud speaker and causes currents to flow in it. These currents absorb energy from the coil, and as a consequence of this energy dissipation its resistance is increased. The higher the frequency the greater is the loss due to the "eddy" currents in the magnet. There is also another source of loss in the magnet. The alternating current in the moving coil causes the magnetisation of the magnet to increase and decrease about its steady or polarising value as shown in

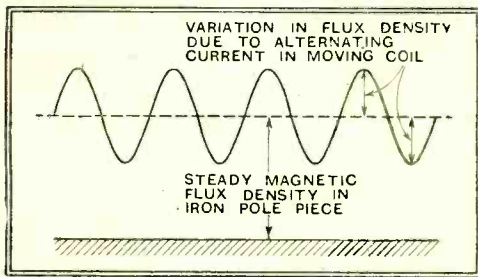

Fig. 3.—Variation in magnetic field of magnet (exaggerated), when alternating current flows in the moving coil.

Fig. 3. But the magnetisation lags behind the current and thereby causes an additional loss to occur. This is known as the loss due to magnetic hysteresis. The word "hysteresis" is derived from a Greek word which means "lagging behind." This loss also increases with the frequency.

We see, therefore, that the alternating current resistance of the moving coil of a loud speaker increases with frequency due to two causes: (1) Eddy currents in the magnet, (2) hysteresis in the magnet. Obviously, from Fig. 2 the increase from 50 to 5,000 cycles is very large indeed, and this causes a considerable fall in the value of the working or signal current.

Inductance of the Moving Coil.

In addition to resistance, we know that the moving coil has an inductance. Without this it could not interact with the magnetic field of the magnet to cause the vibrations representing speech and music. The curve of Fig. 4 shows the variation in inductance of the moving coil with frequency. At 50 cycles it is nearly twice its value at 5,000 cycles, which ratio is almost as striking as that found for the variation in resistance as shown in Fig. 1. Why does the inductance decrease as the frequency rises? The answer to this query

is associated with our friends the eddy currents which we mentioned previously. Referring to Fig. 5, L is a coil having a solid core of steel or iron rod. Suppose we consider the annular ring which is indicated in the diagram. This acts as a secondary coil, L being the primary. The current in L creates a magnetic field which passes through the hollow cylinder as shown by the magnetic lines. The alternation of the field induces a current in the iron cylinder. This current also creates a magnetic field in opposition to the field due to L.

By considering other hollow cylinders of which the solid rod is composed (in imagination), we see that the "eddy currents" induced in it give rise to a magnetic field which tends to destroy or neutralise that due to L. This is the reason why the inductance of L decreases with the frequency. Since $\text{Current} = \frac{\text{Voltage}}{\text{Resistance}}$ it follows that the greater the resistance of the paths in the iron rod which are followed by the eddy currents, the smaller the current and the less the reduction in inductance of coil L.

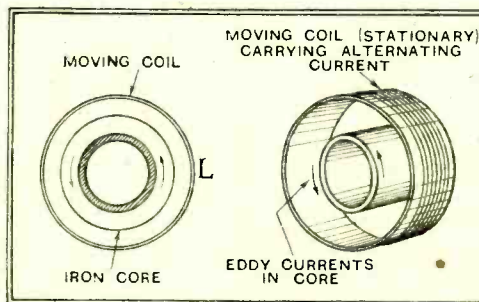

Fig. 5.—Eddy currents in magnet of moving-coil loud speaker due to signal current in coil. The currents thus created cause a loss in the iron and this increases the resistance of the moving coil.

Fig. 6.—Diagram showing the increase with frequency of the reactance of the stationary moving coil.

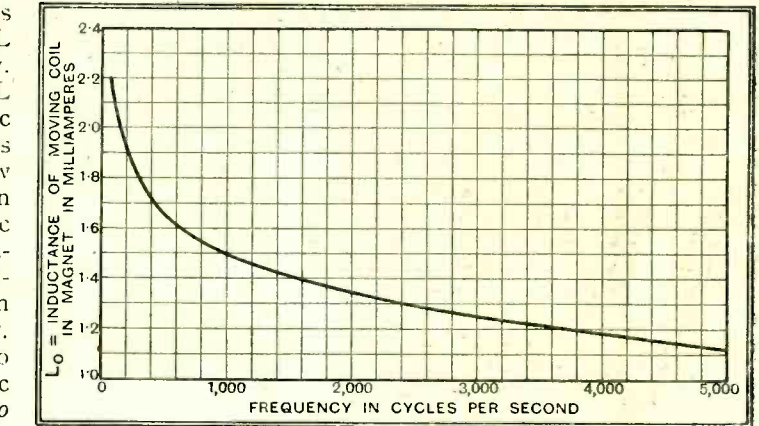
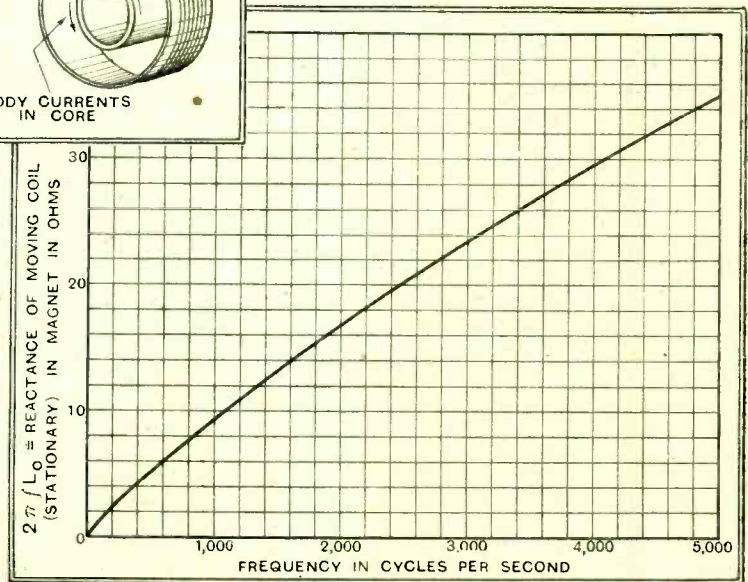

Fig. 4.—Showing the variation with frequency of the inductance of a moving coil.

increases. When the curves of Figs. 2 and 6 are properly combined, the impedance of the moving coil at all frequencies can be obtained. The method of combination is illustrated graphically in Fig. 7. The

resistance at any particular frequency (from Fig. 2) is set off horizontally at AB, whilst the corresponding reactance (from Fig. 6) is set off vertically at BC. The line AC (or hypotenuse of the triangle) is the impedance of the coil at the chosen frequency. In this way the impedance is found at various frequencies, and this enables us to plot the curve shown in Fig. 8. Again we find that the impedance increases with rise in frequency. The curve of Fig. 8 represents the impedance when the moving coil is stationary or fixed in the magnet. Under working conditions, when the coil moves, the impedance is different, owing largely to resonances of the diaphragm structure. The curve of Fig. 9 shows a typical case. At 50 cycles



The influence of the inductance of the moving-coil in reducing the current is obtained from the formula: Reactance = $2\pi \times \text{frequency} \times \text{inductance}$. This is shown in Fig. 6 and has been calculated from the inductance curve in Fig. 4. Although the inductance falls with rise in frequency, the reactance increases, and as a consequence the coil current de-

creases suddenly, due to the diaphragm resonating on the surround. For simplicity, however, we shall confine our attention to the portion of the audible register above 100 cycles.

We have already indicated that when one loud speaker is suddenly removed, the output of the remaining speaker increases some 40 per cent., but the quality

Two Speakers from One Set.—

does not change very much—a slight reduction in upper frequencies principally. Now that we have introduced the impedance of the loud speaker, it is well to argue about things from this standpoint. Removal of the speaker upsets the impedance relationship relative to the valve, and alters the loading and the current accordingly. If we replace the disconnected speaker by an equivalent impedance, the original load conditions will be restored and the remaining speaker will function in its customary manner. This condition can be met quite appropriately if the first speaker is of the energised type and its magnet switched off. Such a condition can seldom be realised, and in many cases the residual field may be sufficient to produce an irritating sound, which might be mistaken for someone trying to coax the mice or rats!!

As a first real attempt, suppose the speaker is replaced by an ordinary resistance. We have seen that the moving-coil speaker resistance varies with the frequency, so we are now in a dilemma as to what resistance should be chosen. Suppose we try a few values to ascertain which is best. In Fig. 10a the arrangement to be used is sketched diagrammatically, R_s being the substitute resistance, and L, R the moving coil. When R_s is the same value as R at 100 cycles (14 ohms), the current at that frequency will be almost equally divided between the coil and R_s . As the frequency rises, so also does R (see Fig. 2), so that the current is diverted through R_s more and

more as 5,000 cycles is approached. The result will obviously be a reduction in the upper frequencies, and the quality becomes more mellow. When $R_s = R$ at 2,000 cycles (18 ohms), the current below this

with these two it is possible to do a little tone control. When the inductance is large and the series resistance small, the high frequencies will be forced through the speaker, and the low frequencies shunted by the tone control circuit. The result is a very definite change in quality, and the reproduction will be more brilliant than before. By carrying the preceding adjustment to an extreme condition, the bass register can be made to vanish substantially. It must not be imagined that this procedure extends the upper register. All that happens is that the upper frequencies remain much as they were, whilst the lower tones are reduced or attenuated due to the bye-passing section of the shunt circuit $R_s L_s$.

Summary.

In working two loud speakers in parallel from the same transformer the speakers operating in different rooms, the output of either speaker increases if the other is removed. The change in quality is not serious, but consists in a slight weakening of the upper frequencies. To correct the increase in power, the idle speaker should be replaced by an equivalent electrical impedance consisting of an iron-cored choke and a resistance, or a choke wound with a coil of appropriate resistance. A compromise can be made by substituting a suitable non-inductive resistance, but this will modify the quality, and the output at all frequencies will not

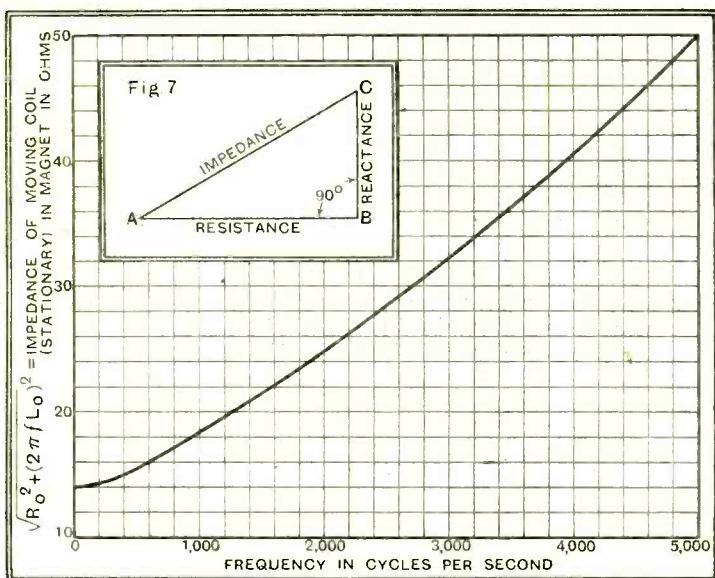

(Inset) Fig. 7.—Geometric representation between inductive reactance, resistance and impedance of the speech coil in a moving-coil loud speaker.

Fig. 8.—Variation with frequency of the impedance of a stationary moving coil.

frequency will flow mainly in the coil, because it is of lower impedance than R_s . Above 2,000 cycles it will flow increasingly through R_s . It appears, therefore, that, whatever the value of R_s , there will be a reduction in output at the higher audible frequencies. From this it follows that volume control of a loud speaker by shunting a resistance across its winding causes a change in the quality of reproduction. At very low intensity levels the resistance of the shunt is low, and the upper frequencies are by-passed instead of going through the loud speaker.

What we require is something whose impedance increases with frequency. The simplest device is a loud speaker coil identical with that on the speaker having a solid metal core to simulate the electromagnet. Alternatively some form of coil with a laminated core capable of being pulled in and out to vary the inductance can be connected in series with a variable resistance as shown in Fig. 10b. Then, by juggling

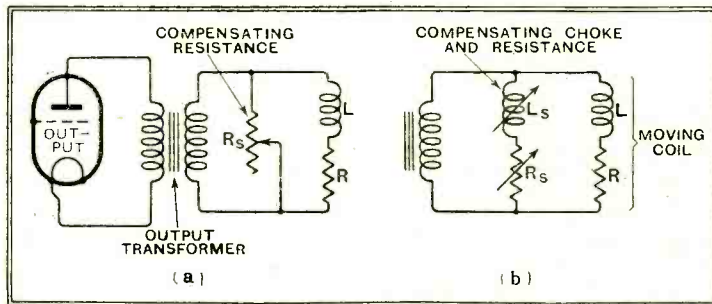

Fig. 10.—(a) Diagram representing the use of a shunt resistance to compensate approximately for the removal of one loud speaker from a system normally employing two. (b) Accurate compensation for a loud speaker by means of a variable inductance and variable resistance.

be strictly the same as if the equivalent impedance were used.

Long leads are inevitable in wiring a house for the above scheme, but since they are connected to the low-voltage winding of the transformer, their condenser action in shunting high frequencies and preventing them reaching the speaker is quite small.

BOOK RECEIVED.

Wireless and Shipping: A Record of Progress.—A short history of the growth of wireless and its use on board ship from Marconi's early experiments up to the present time, and including articles by Marchese Marconi, Sir Archibald Hurd, Mr. E. H. Shaughnessy, Dr. S. H. Long, and other authoritative writers. Pp. 87+iv., with numerous illustrations. Published by the "Shipping World," Ltd., London. Price 2s.

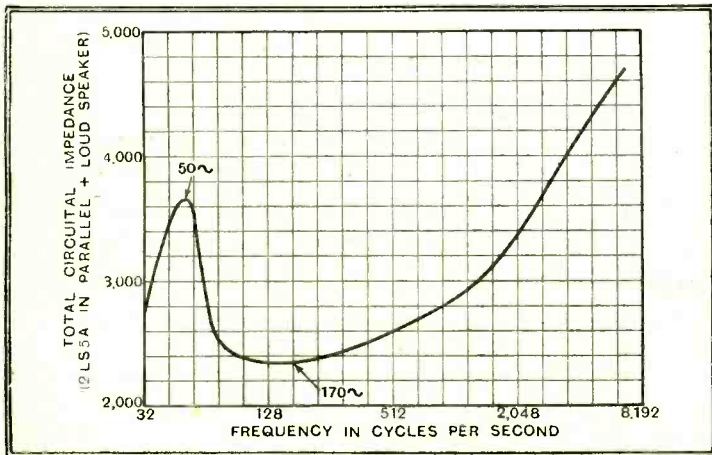

Fig. 9.—Curve giving combined impedance of moving-coil loud speaker and power valve of internal resistance 1,500 ohms. The peak at 50 cycles is due to resonance of the diaphragm on the surround.

News of the Week.



A FLOATING LABORATORY. Marchese Marconi's well-known yacht "Elettra" anchored in St. Marcus Dock, Venice, during the important experiments in ultra-short wave transmission and reception which the Marchese is now conducting in Italy.

Precisely 1,000 Cycles.

PRECISION modulation tests on 1,000 cycles are shortly to be transmitted at regular intervals by the station of the National Physical Laboratory, working on 830 metres.

Northward Ho!

RADIOLYMPIA travels north this week in the vast convoy leaving the Thames Embankment on September 25th. Demonstrations will be given from the vehicles *en route*. A one-night show will be held at Leicester.

The Northern Wireless Exhibition opens at City Hall, Manchester, on Wednesday next, September 28th, and the ceremony will be performed by Mr. J. H. Whitley, the Chairman of the B.B.C. Board of Governors.

"The Listeners' Delegate."

PROFESSOR RAYMOND BRAILLARD, chief of the delegation of the Union Internationale de Radiodiffusion at Madrid, is becoming known as "the listeners' delegate." On behalf of listeners he is fighting for twenty-three more waves for broadcasting. According to a correspondent, M. Braillard is asking for the band 555 to 580 metres for stations far inland, and 620 to 650 metres for other stations incapable of interfering with marine traffic.

He is also seeking to obtain entirely for broadcasting purposes the wavebands between 650 and 810 metres and 1,050 and 2,000 metres.

All European listeners will unite in wishing their champion the success for which he hopes.

Medical Chats by Radio.

MEDICAL chats are now broadcast every Monday and Wednesday by the Radio L.L. station in Paris. Listeners have already learned all that is worth knowing about arterio-sclerosis, the troubles of the vocal organs, dental anomalies, and nasal disorders. They are shortly expecting to have their teeth extracted by television.

What of PCJ?

BRITISH listeners to the once-famous Dutch experimental station PCJ at Eindhoven are wondering how much longer the reopening of the station is to be deferred. The closure took place in November last, when Messrs. Philips announced that a complete reorganisation of the transmitter was to be undertaken, and since then little has been heard concerning the future of what was undoubtedly one of the most famous of the world's broadcasting stations.

We understand that the owners are now negotiating with the Dutch Government on the questions of wavelength and power.

Shorter Wave for Luxembourg.

A NEW Luxembourg mystery has been created by the news of the departure of two prominent officials. The actual founder of the station, M. Etienne, has left Luxembourg "to take up other duties."

The French news and publicity agents, Havas, who are large shareholders in the new venture, have nominated one of the new directors. Our correspondent understands that the second director is a prominent personality in Luxembourg itself.

Rumour has it that this 200-kilowatt propaganda station will not, after all, use a long wavelength. It is believed that transmission tests will begin on the high-power aerial in October. At present low-power transmissions are given daily at 13.30 to 14.30 and 17.30 to 18.30, the call being "Ici Radio Luxembourg émission expérimental."

No Tax for Hungarians.

THE Hungarian Government has had its fingers bitten in an attempt to impose a tax upon radio listeners. According to our Vienna correspondent, the Government's first tentative efforts in this direction met with an intense protest not only from the public and the Press, but also from the radio dealers, with the result that "the incident is closed."

Independent.

BARI is at present the only Italian station which is entirely independent of the others. Opened on September 6th, the station had to entertain listeners with its own programme, the connecting cable with the remainder of the Italian network not having been completed.

Listeners must not be deceived by the voice of Signorina Rosa, at present announcing at Bari. Signorina Rosa is the popular announcer of Radio Napoli (Naples).

The Paris Radio Shows.

THE 9th Wireless Salon in Paris was held simultaneously with the "2nd International," the former being sponsored by the Manufacturers' Association, but neither seems to have suffered by the synchronisation of dates. Both had Government support. The Exhibitions attracted a large number of visitors, and it was remarked that the activity of the French wireless industry seems to have suffered little from the economic crisis. Radio-gramophones showed increased popularity.

Tax for French Listeners.

AT the inaugural banquet connected with the "official" Paris show, Colonel Brenot, the President, paid a tribute to the wisdom of the Postmaster-General, M. Queuille, in deciding on the construction of the new high-power broadcasting stations at Paris, Lyons, Nice and Toulouse. At the same time, however, he appealed to the Government to ensure continued recognition of the private stations, and thus procure the greatest possible liberty for the "spoken Press."

In his reply, M. Queuille announced his intention to introduce a broadcasting Bill providing for a tax on listeners as the logical means for obtaining funds for developing a national service.

Man Hurt at Paris Show.

OUR Paris correspondent reports that a nervous kitten strayed into the Paris wireless salon and gave vocal vent to its distress while two English-speaking visitors were discussing the latest technical features. One of them was heard to remark that this was the most comprehensive up-to-date show he had yet seen. "Even the cats," he remarked, "have variable-mu."

Happily the man was only slightly hurt, the majority of visitors being ignorant of English.

Radio Push in Czecho-Slovakia.

CZECHO-SLOVAKIA, thirteenth among the European nations in regard to broadcasting development, has just concluded a wireless propaganda week. At present there are only 25 wireless users per 1,000 inhabitants.

The enemies of radio development in Czecho-Slovakia are the Carpathian Mountains and the Czecho-German conflict of tongues, but the Czechs are a persevering race, and no one knows how far they may soon leap up the European broadcasting ladder.

Blow to German News Broadcasting.

GERMAN listeners are bemoaning the fact that, whereas the B.B.C. has announced its intention to brighten up the news bulletins, the German broadcast news service threatens to become more dull and turgid from week to week.

The resignation of Dr. Rauscher, Managing Editor for all the German news bulletins, is regarded as the finishing stroke; henceforth it looks as if the broadcasting news will consist of little else but official bulletins.

Ordered to Listen.

SOLDIERS of the Soviet Army have been ordered to listen to the radio programme for one hour daily. This is certainly preferable to the old-fashioned "confined to barracks."

Police Radio for Edinburgh.

EDINBURGH is the latest city to consider the use of police wireless of the type described in recent issues of this journal. A special radio telephone demonstration is to take place at the police headquarters on October 8th.

Winter Wireless Courses.

MANY opportunities now exist for obtaining wireless instruction in the evenings. The new session of the Polytechnic, 309, Regent Street, London, W., opens on Monday next, September 26th, when courses in wireless and high-frequency engineering will begin. These have been designed to provide a thorough training in the principles of technique of high-frequency engineering for all interested in wireless, gramophone, or talking film work. The Polytechnic includes well-equipped laboratories, with facilities for radio telegraphy and telephony transmission with the transmitter 6RA. Full particulars of hours and fees can be obtained on application.

At the Manchester Municipal College of Technology, special lecture and laboratory courses on "The Principles of Operation and the Servicing of Radio Receiving Sets" will open on October 5th, the lecture and laboratory work both taking place on Wednesday evenings throughout the winter. Intending students will be enrolled on Wednesday, September 28th, from 6.30 to 8.30 p.m.

The Borough Polytechnic, Borough Road, London, S.E.1, opens courses in synthetic resins, chemistry, and electricity and magnetism on September 26th.

Exit the Sergeant-Major.

DURING the Danish military manoeuvres this autumn, the non-commissioned officers have been replaced by loud speakers giving the marching orders. In addition to being cheered by the absence of the traditional sergeant-major, the privates did their drill to the accompaniment of military band music supplied by public address apparatus installed on a special wagon.

Our Powerful Neighbour.

HOPES are now held out that the new Irish high-power broadcasting station at Moydrum, near Athlone, will be working next month with an unmodulated aerial energy of 60 kilowatts and modulation up to 80 per cent. Arrangements have been

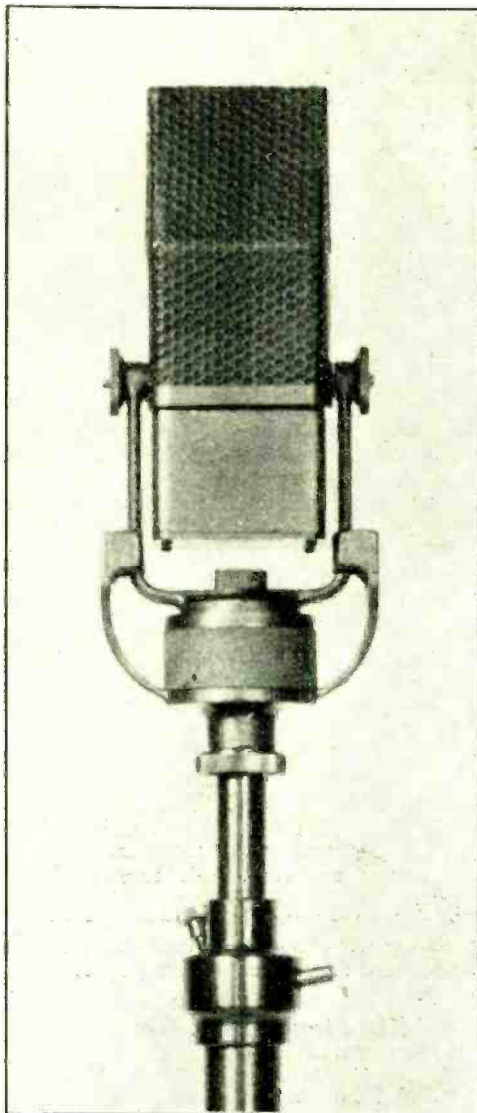

THE "VELOCITY MICROPHONE." A new product of the Radio Corporation of America. Its moving element is a light metal ribbon which vibrates at a velocity proportional to that of the sound wave, and is stated to have no resonant frequency. The makers also claim wider frequency range.

made whereby the power of the transmitter can be doubled at a later date.

It is expected that the wavelength used will be 413 metres, although the transmitter, which is of Marconi construction, can be operated on any wavelength between 300 and 550 metres. The aerial at Moydrum will be of the "T" type, suspended between two stay-insulated masts each 100 metres in height and about 225 metres apart.

DISTANT RECEPTION NOTES.

THE advantages of using some kind of tone-correcting device in the highly selective long-distance set are great.

With a suitable corrector a pleasant balance can be obtained from either speech or music from almost any station that can be tuned in. I expected when I fitted a tone corrector to a superheterodyne receiving set that, once a suitable adjustment had been found, the control knob would not require to be touched again. The same idea will, I expect, occur to most readers who use superheterodynes without any reaction arrangements or variable couplings, since the degree of selectivity does not vary. In practice one finds that it pays to make a small variation in the tone-corrector adjustment for nearly every station.

One reason for this is probably that the attenuation of the outer sidebands is much more noticeable in some cases than in others. Actually, it appears that there is a very considerable difference of opinion amongst Continental broadcasting authorities with regard to the best balance of frequencies in transmission. Some send out more bass, some more "top" than others. Without a tone-correcting device distant stations which "boost up" the bass can hardly give pleasing reproduction in this country. The tone corrector thus enormously increases the pleasure of long-distance reception.

The Long Waves.

Though it is recognised that transmissions upon wavelengths of over 1,000 metres are much less affected than those using shorter wavelengths by conditions of daylight and darkness, or by the seasonal conditions of summer and winter, there is each year a distinct falling off in the summertime reception, both by daylight and in the evening, of several of the long-wave stations. This year Warsaw, Motala, Kalundborg, and Oslo have all been affected, Motala, in fact, was for some little time poorly received in the Midlands and in Southern England. One can now record a complete revival of these four stations, each of which has become quite reliable except at times when reception conditions are abnormally bad. When we add Huizen, Radio-Paris, and Zeesen, all of which are first-rate, the long waves are found to provide no less than seven genuine alternative programmes, apart from those of the Midland National.

Below 550 Metres.

Here, again, the signs of improvement that occur as autumn approaches are very marked. There are several key stations whose signal strength in this country provides valuable indications each year. Near the top of the medium waveband, Budapest and Vienna serve in this way. These are amongst the earliest stations to show a falling off in the springtime. They are generally heard spasmodically during the summer, but when they begin to return as stations that are regularly receivable one knows that the best period for long-distance reception is rapidly approaching. Of the twenty-one consecutive evenings before this note was written, Budapest was well received on ten and Vienna on eight; but five good performances from Budapest and four from Vienna were recorded in the last seven days of the period. The signs, therefore, would seem to be that autumn reception conditions are rapidly approaching.

D. EXER.

MANCHESTER RADIO SHOW.

Wednesday, September 28th to Saturday, October 8th.

IN NEXT WEEK'S ISSUE

will appear a description of the more important exhibits, particular attention being paid to new apparatus not shown at Olympia. Also a complete plan of stands and list of exhibitors.

LABORATORY TESTS

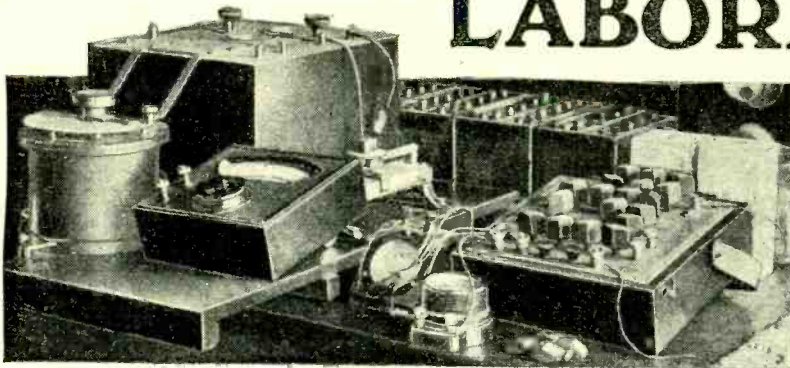

**NEW
RADIO
PRODUCTS
REVIEWED**

A NEAT TERMINAL BLOCK.

A RECENT addition to the Goltone range of components made by Ward and Goldstone, Ltd., Frederick Road (Pendleton), Manchester, takes the form of a small single terminal block designed for mounting either horizontally or vertically either on a baseboard or on the wall or window surround. A useful feature is the provision of a circular recess for the accommodation of an indicating disc when plain terminals are used.

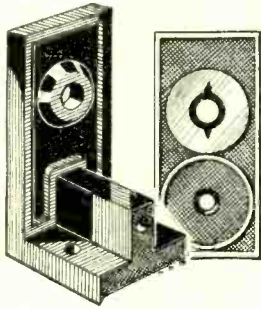

Goltone single terminal mount.

The moulded block is exactly one inch wide and 2 ins. high, so that when a number are mounted side by side the space required is no greater than would be the case if a single terminal strip were used. Knife-edged ridges are provided on the moulding to grip the material to which it is fixed, thereby preventing the block turning or slipping when once positioned. The price is 9d. per pair.

BERCLIF SUPERHET I.F. TRANSFORMER.

A PARTICULARLY useful feature of the new Berclif superheterodyne band-pass intermediate frequency transformer is that provision is made for adjusting the coupling between the two coils, and hence the band width, while the receiver is in operation, so enabling the best setting to be found under the most favourable conditions. This is achieved by a screw control protruding through the top of the screen, which when

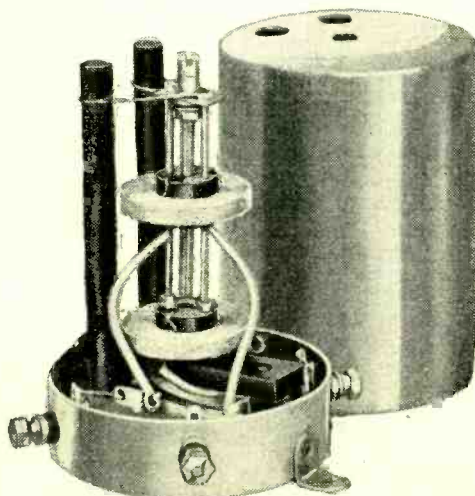

Berclif 110 kc. band-pass superheterodyne I.F. transformer.

turned in a clockwise direction increases the distance between the coils, so giving a looser coupling and better selectivity, while rotation in the opposite direction brings the coils in closer juxtaposition; this then gives an increased band width.

Accommodated in the base of the container are the two trimming condensers, and since each is fitted with a long ebonite spindle, the ends of which pass through holes in the aluminium cover, all three controls are located in the most accessible position.

The specimen tested was wound to peak at 110 kc., which condition should be achieved quite easily under all conditions in practice, for our measurements show that the trimming condensers are capable of covering a range of frequencies extending from 90 kc. to 140 kc. approximately.

The transformer is very compact, for the overall height is but 3 1/2 in., while the diameter of the container is 2 1/4 in. The price is 10s. 6d., and the makers are Berclif, Ltd., 38, Rabone Lane, Smethwick, Staffs.



Pertrix Ultra 120-volt H.T. battery with a discharge rate of 12 mA.

PERTRIX "ULTRA" H.T. BATTERY.

THE cells in the new Pertrix Ultra capacity series of H.T. batteries are slightly larger than those used in their standard capacity range, and as a consequence the maximum discharge rate has risen from 9 to 12 mA. The new models, however, are listed at the same price as the earlier standard size, which is 8s. for a 60-volt unit, 13s. for one of 100 volts, and 15s. 6d. for a 120-volt model.

A specimen 120-volt battery was tested by discharging it intermittently, the working periods being of four hours' duration, with similar time intervals for recuperation. In the graph, however, the rest periods are omitted and the actual working hours only are shown.

If the battery is discharged initially at about the maximum rate allowed for this model, we find that a useful life of at least 250 working hours may be expected. The end-point is taken to be when the E.M.F.

has fallen to 0.75 volt per cell, and as there are 84 cells in the 120-volt unit the battery will show a shade over 60 volts at this stage.

Beyond this point the decline in voltage accelerates to such an extent that little advantage is gained by keeping the battery in commission for a longer period.

The total capacity to the end-point chosen amounts to 145 watt hours, so that each cell contributes about 1.7 watt hours. This is slightly above the average for the standard capacity size, which in general

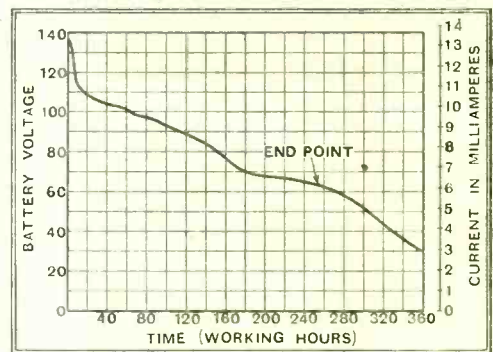

Discharge curve of Pertrix Ultra capacity 120-volt dry-cell battery.

afford a capacity of about 1.5 watt hours per cell, but it is much less than that of the "super" models, for these average approximately 3.2 watt hours each.

The Pertrix Ultra capacity batteries occupy, therefore, an intermediate category, which is more closely related to the standard models than to the "Super" sizes. They will provide an economical source of high tension under all conditions of working, provided that in the initial stages the total anode current taken by the set does not exceed some 12 mA.

The makers are Britannia Batteries, Ltd., 233, Shaftesbury Avenue, London, W.C.2.

KNIFFY RADIO PIN.

A SMALL insulated pin designed for securing either twisted flex or two separate conductors to wood or plaster is now obtainable from F. Kniveton, 7b, London Road, Enfield, Middlesex. Known as the Kniffy Radio Pin, it consists of an insulated head provided with an annular groove and also two parallel channels. The former would be used for fixing flex wires, while the latter will serve to secure single conductors. They are made in six different colours, and cost 1d. each, or 7 for 6d.



Kniffy Radio Pin for securing flex or twin wires to wood or plaster.

Catalogue Received.

H. W. Sullivan, Ltd., Leo Street, Peckham, London, S.E.15. Four new catalogues, including particulars of the latest Sullivan measuring instruments as follows:—(1) *Laboratory Condensers* (variable air condensers, fixed air condensers, and mica condensers). (2) *Wavemeters* (including frequency standards, inductance standards, and allied radio-frequency apparatus). (3) *Precision A.C. Measuring Apparatus* (non-reactance resistances, bridges, and capacity test sets). (4) *Precision D.C. Measuring Apparatus* (galvanometers and shunts, high resistances, Wheatstone bridges, etc.).

Standard Battery Company's FUTURA SIX.

A Sensitive Receiver with Unconventional Features.

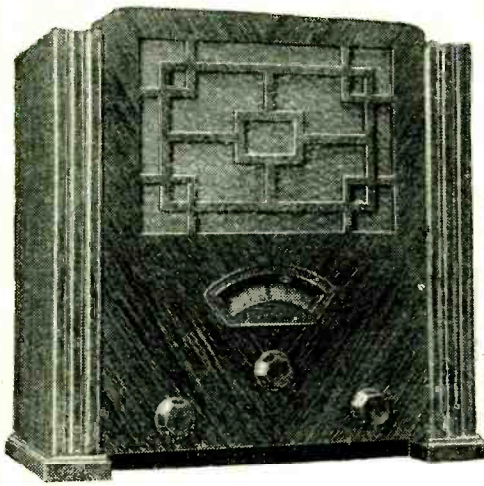

IN spite of opinions freely expressed before Olympia, "straight" sets with multi-stage H.F. amplifiers showed no sign of fading into obscurity; on the contrary, some particularly interesting examples of this circuit arrangement were put forward. A new aspect of the subject came to light; having settled the vital question of the number of tuned circuits to be included in his receiver, a designer has now to consider whether one of them may best be employed as part of a band-pass filter, or, alternatively, in conjunction with an extra S.G. valve, as an H.F. coupling. True selectivity will be about the same in either case, but where the second plan of single-circuit tuning with an additional H.F. valve is adopted, apparent selectivity may be made much higher without very great sacrifice of amplification. Sensitivity will accordingly be much greater.

The Futura Six is a product of the second school of thought. It is a rather more ambitious set than the type of 2-v-1 combination which competes with the ubiquitous H.F.-det.-L.F. three-valve set, but is quite as compact as the average specimen, and costs but little more. By the usual classification, it is a five-valve set, the sixth valve being a power rectifier. Basically, the circuit arrangement comprises two H.F. stages, an anode-bend detector, and a resistance-coupled L.F. amplifier with an intermediate stage between detector and output valves.

Anode-bend Detection.

As already implied, there are three single-tuned circuits, controlled, of course, by a three-gang condenser. The aerial input arrangements are conventional, but the H.F. couplings are unusual, in that the anode impedance coils are in inductive relationship to some extent with the tuned windings, and so the arrangement acts partly as a transformer, at any rate on the long-wave band.

Self-bias for the anode-bend detector is provided by the insertion of a resistance in the cathode lead, and this tends to limit the output on strong signals; thus it acts to some extent as an automatic volume control. The resistance-capacity couplings between this valve and the L.F. amplifier, and thence to the output stage, are quite

conventional, and anode-circuit decoupling is included.

As the H.F. valves are of the variable-mu type, it goes without saying that volume is controlled by variation of the grid bias applied to these valves. This is effected by a variable resistance (in series with a fixed limiting resistance) in the common cathode lead; the usual potentiometer arrangement, designed to prevent variations in H.T. voltage, is not employed. Bias for the output valve is derived from the drop in voltage across a resistance inserted in the negative H.T. feed lead, and this circuit is decoupled.

Instead of connecting the loud speaker field winding in series with the H.T. lead and using it as a smoothing choke, a winding of much higher resistance than usual is employed, and it is connected in shunt with the rectifier output. Smoothing is effected by a choke in the negative H.T. lead.

Compact Layout.

Matters are not stinted in the power supply system; maximum rectified voltage is over 300 volts, and the loud speaker field consumes about 45 milliamps. from this source. After allowing for the loss in the smoothing choke and bias resistance there still remains about 250 volts for the anodes, so the valves are worked well up to their rating. Actually, manipulation of the volume control brings about a good deal of variation in voltage. So far as the output valve is concerned, its current varies roughly between 15 and 25 milliamps., but this does not affect power output adversely from a practical point of view, as the higher anode current is obtained when the H.F. grids are fully negative; they will generally be operated in something approaching this condition for the reception of a local station, from which the best possible quality and volume is naturally desirable.

Wireless receivers are nowadays constructed on stereotyped lines, and there are few radical departures from convention in the Futura Six. The coils are screened in rectangular boxes, which, of course, are just as efficient as those of circular cross-section, and seem to lend themselves to a neater layout. There are no other constructional features to which special attention need be drawn, but it should be put on record that, considering the number of valves, the set is extraordinarily compact and "clean," and the general standard of workmanship is high.

There can be no doubt that the Futura Six is a highly sensitive set. With the most inefficient aerial it would satisfy average requirements, but, very rightly,

the makers insist on the desirability of a reasonably efficient collector. Range is then practically limited only by local conditions in the matter of electrical interference. The set itself is not noisy, but there is a little mains hum.

High Selectivity.

This high sensitivity might imply a sacrifice of selectivity, but no shortcomings are evident on this score. For a three-circuit set the performance is outstandingly good, and interference is seldom encountered, even with the tighter of the additional aerial couplings. For this the anode-bend detector is probably to some extent responsible.

The volume control works satisfactorily, but might be a little more progressive; at certain wavelengths it is just possible to provoke self-oscillation, but this is hardly a disadvantage, as it allows extreme selectivity to be obtained at times when receiving conditions are good enough to allow it to be usefully employed.

Output from the loud speaker in the bass register is "clean," and there is plenty of it, without any marked resonance. At the other end of the scale there is quite good reproduction of frequencies up to some 3,500 to 4,000 cycles, and the only criticism to be made is that a certain roughness on deeply modulated high-frequency passages sometimes becomes evident; this might be due to the production of harmonics owing to slight curvature of the characteristic of the anode-bend detector valve.

Speaking generally, the set should be well capable of meeting the needs of those who require something considerably more sensitive and rather more selective than the more popular type of "standard" receiver.

FEATURES.

General.—A self-contained table model receiver with built-in moving-coil loud speaker. For operation on A.C. mains with an external aerial. Dial calibrated in wavelengths and stations. Provision for extra loud speaker and gramophone pick-up.

Circuit.—Single-tuned input circuit: 2 H.F. stages followed by anode-bend detector and 2 resistance-coupled L.F. stages. Triode output valve feeding energised loud speaker. Full-wave power rectifying valve.

Controls.—(1) Ganged tuning condenser. (2) Combined on-off switch and volume control. (3) Combined wave-range and gramophone switch.

Price.—20 guineas.

Makers.—The Standard Battery Company, 184, 188, Shaftesbury Avenue, London, W.C.2.

TWO H.F. STAGES AND A RESISTANCE-COUPLED L.F. AMPLIFIER.

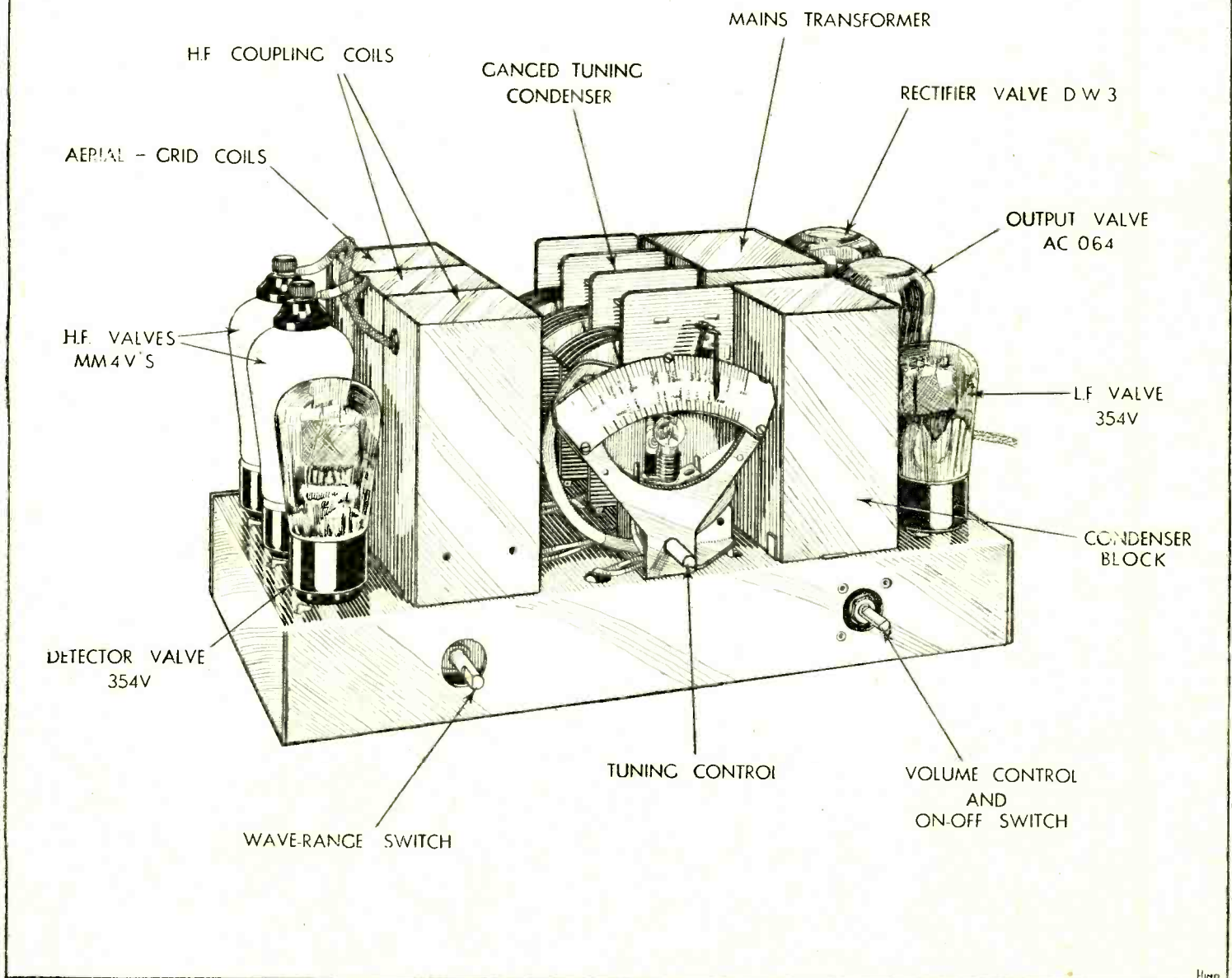
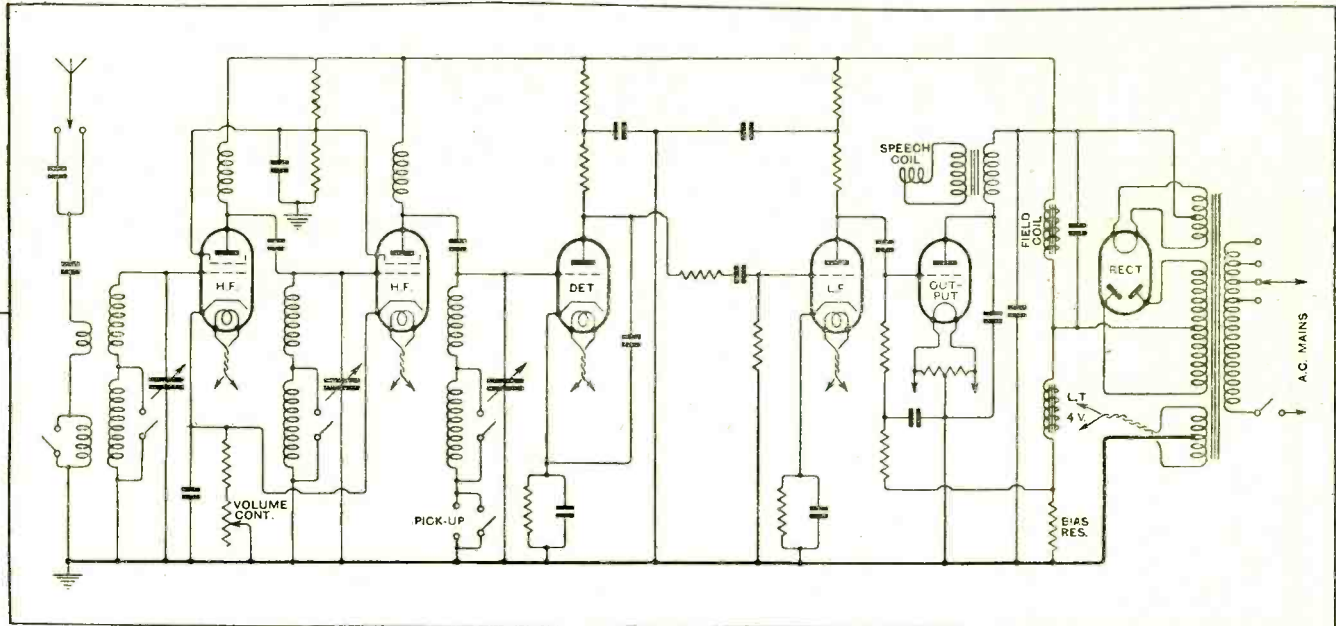

Details of the Futura Six chassis, and (inset) the complete circuit diagram.

READERS' PROBLEMS.

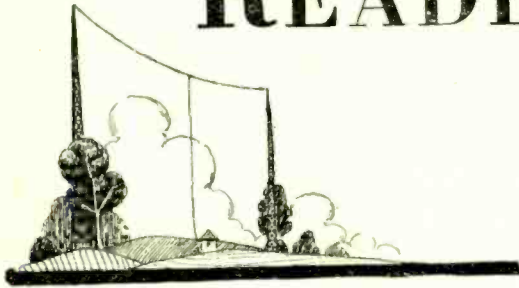

The "Baby Super."

READERS who already possess satisfactory H.T. eliminators have asked whether the "Baby Super" could be operated from their units in place of the built-in power equipment. In almost every case it is intended to operate the set with a loud speaker of the permanent-magnet type, or with one that embodies provision for the supply of field energising current.

The general answer to these questions is that the set may be operated perfectly satisfactorily in this way, but—and the "but" is important—the eliminator must be capable of delivering about 60 milliamps of smoothed current at 200 volts, and also 4 volts at 4 amperes, of raw A.C. heater current.

The great majority of eliminators are unable to satisfy this requirement, and, rather than impair performance by under-running the set to an appreciable extent, we consider that it would be better to wait for the battery version of the set, which will be described in the near future in these pages.

Low-periodicity Mains.

IT is generally appreciated that the basic design of all commercial A.C. receivers, as well as of those described in this journal, is prepared for a 50-cycle supply. We find it rather difficult to make specific recommendations to those querists who ask for precise information as to how various designs should be modified for use on 25-cycle mains; strictly speaking, to obtain the same degree of smoothing, the inductance of the choke and the capacity of the associated condenser should be doubled in value, but in practice such a great increase as this is hardly ever necessary, for the reason that the receiver, loud speaker, and the human ear, are all less responsive to the hum frequency, which will also be of lower periodicity.

This is a case where the "trial and error" method is generally to be advocated. If convenient, the smoothing choke may be of rather higher inductance than that originally specified, and for a first trial the smoothing condenser may be the same. Then, if hum is excessive, an extra condenser may be connected in parallel.

Fixed-voltage Eliminators.

COMMERCIALLY speaking, it is quite impracticable, and in any case it would be terribly extravagant, to make an H.T. battery eliminator of which the output voltage could be depended upon to be "true to label" under all conditions of operation. In practice, the marked voltage will always be exceeded when the instrument is under light load, and equally it will fall when the current demands are unduly heavy.

THESE columns are reserved for the publication of matter of general interest arising out of problems submitted by our readers.

Readers requiring an individual reply to their technical questions by post are referred to "The Wireless World" Information Bureau, of which full particulars, with the fee charged, are to be found on page 295.

Several correspondents who have found by experience the correctness of this statement have shown interest in descriptions, published in our Olympia Show reports, of one or two eliminators in which an extra adjustment is provided, with the object of avoiding uncertainty as to the actual output voltage. In several cases we are asked to describe a method of fitting a regulating device to an existing instrument.

These questions may be answered collectively by saying that reasonably constant output voltages may be ensured either by fitting a suitably tapped series resistance, as in Fig. 1 (a), or by adding a parallel loading resistance, as shown in diagram (b). Having calculated roughly the total demands to be imposed upon the eliminator by the receiver

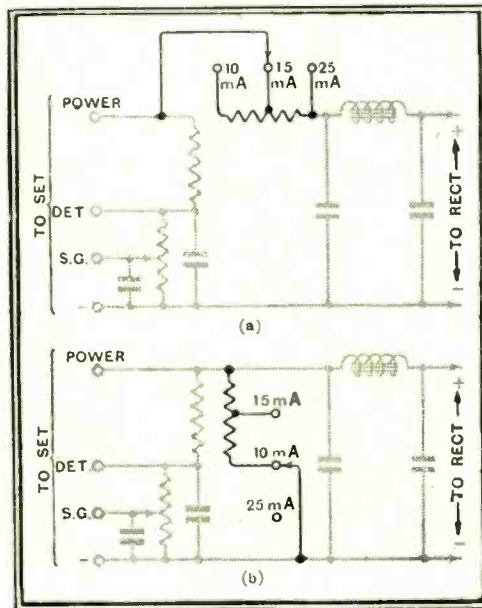
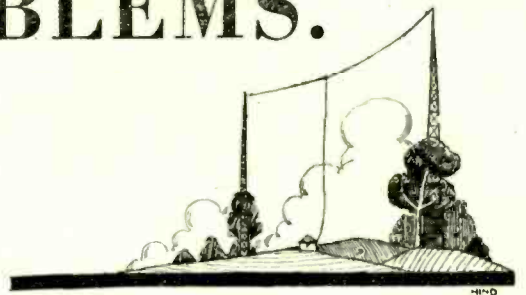

Fig. 1.—Alternative methods of modifying an H.T. eliminator in order to avoid appreciable voltage rise when the instrument is delivering less than its maximum rated current

to which it is to be connected, connection would be made by means of a plug, or in any other convenient manner, to the tapping point corresponding most closely to the estimated current load.

The series resistance plan is probably the most suitable for a commercial design, but the tapped loading resistance of diagram (b) will generally be found best by those who are modifying an existing eliminator, if only because it is possible to estimate the value of resistance needed without knowledge of the regulation curve of the rectifier, etc., and without the use of measuring instruments.



For purposes of illustration we will assume that the second arrangement is to be applied to an eliminator rated to give 25 milliamps. at 150 volts. To estimate the value of shunt resistance required to maintain this voltage at lighter loads, it is merely necessary to divide "maximum rated voltage" by "surplus current." This latter quantity is the difference between the maximum current rating of the eliminator and the current actually to be drawn, and is expressed as a fraction of an ampere.

The loading resistance required to maintain rated voltage in the eliminator taken as an example under the reduced load of 10 milliamps. will therefore be $\frac{150}{0.015} = 10,000$ ohms. For a load of 15 milliamps. the shunt must be $\frac{150}{0.01} = 15,000$ ohms. This artificial load can best be arranged in the form of a resistance of 15,000 ohms with a tapping at 10,000 ohms.

The New Frequency Changer.

REFERRING to the new type of frequency changing circuit, in which a pentode is used as a combined oscillator-detector, a reader asks whether an oscillator coil assembly built on standard lines is likely to be suitable, as he wishes to try this arrangement. If it will not, he asks us to suggest the probable nature of any modifications that may be necessary to this component.

It will generally be found that with an ordinary oscillator coil, in which there is a common reaction winding for both wave-bands, there will be difficulty in obtaining oscillation over both medium and long wave-bands. As a general rule, it is better to provide separate coils for each band, making arrangements to short-circuit the long-wave reaction winding in the same way as the tuning coil. Indeed, especial care should be taken in the design of the whole coil assembly, and coupling between the reaction winding and the tuned sections should be "tight." The actual number of turns is determined fairly easily by trial and error. The aim should be to devise a reaction winding that will maintain self-oscillation over the whole frequency band, and yet will not be tight enough to provoke a low-frequency howl.

Still referring to the same subject, another querist asks whether a certain make of I.F. transformer which he already has could be used with this circuit.

We fear that it could not; the transformer mentioned by our correspondent has no tuning condenser across the primary, and so the oscillator feed circuit could not be arranged as suggested in our issue of August 5th. This condenser, besides performing its normal function, is used as a feed capacity for the oscillator circuit.

The Wireless World

A
PRACTICAL RADIO
JOURNAL
22nd Year of Publication

No. 683.

FRIDAY, SEPTEMBER 30TH, 1932.

VOL. XXXI. No. 13.

Editor:

HUGH S. POCOCK.

Proprietors: ILIFFE & SONS LTD.

Editorial Offices:

116-117, FLEET STREET, LONDON, E.C.4.

Editorial Telephone: City 9472 (5 lines).

Advertising and Publishing Offices:
DORSET HOUSE, TUDOR STREET,
LONDON, E.C.4.

Telephone: City 2816 (15 lines).
Telegrams: "Ethaworld, Fleet, London."

COVENTRY: Hertford Street.

Telegrams: "Cyclist, Coventry." Telephone: 5210 Coventry.

BIRMINGHAM:

Guildhall Buildings, Navigation Street, 2.

Telegrams: "Autopress, Birmingham." Telephone: 2970 Midland (3 lines).

MANCHESTER: 260, Deansgate.

Telegrams: "Hiffe, Manchester." Telephone: Blackfriars 4412 (4 lines).

GLASGOW: 26B, Renfield Street, C.2.

Telegrams: "Hiffe, Glasgow." Telephone: Central 4857.

PUBLISHED WEEKLY. ENTERED AS SECOND
CLASS MATTER AT NEW YORK, N.Y.

Subscription Rates:

Home, £1 1s. 8d.; Canada, £1 1s. 8d.; other
countries abroad, £1 3s. 10d. per annum.

As many of the circuits and apparatus described in these pages are covered by patents, readers are advised, before making use of them, to satisfy themselves that they would not be infringing patents.

CONTENTS.

	Page
Editorial Comment	307
The Diode Quality Four	308
The New Tuning Coils	312
Unbiased	315
Practical Hints and Tips	316
PROGRAMMES FROM ABROAD, I—XXIII	
News of the Week	317
Manchester Radio Show	318
H.M.V. Superhet Portable Six	324
Correspondence	326
Automatic Gain Control, Part II	327
Broadcast Brevities	329
Readers' Problems	330

EDITORIAL COMMENT.

New Readers' Number.

Special Features Next Week.

IF wireless can still be regarded as seasonal, then certainly we can say that the season has now opened. This week sees summer time brought to a close and the commencement of the longer evenings, when wireless is everywhere more popular than in the summer, during which so many other occupations serve to distract attention from listening.

In spite of summer conditions for reception, many foreign stations have been coming in better than during the winter months of previous years, due mainly to the increase in transmitting power and improvements in receivers. This being so, we may well look forward to this season as providing an unequalled opportunity for distant reception. Foreign stations are likely to be more popular with listeners here than ever before.

The New Tuning Chart.

Unusual interest attaches to next week's issue of *The Wireless World*, which is a special number for new readers, but which will also interest all present readers. A useful supplement, in the form of a new "Foreign Station Tuning Chart," will be included, which will enable the calibration of receivers to be brought up to date with a high degree of accuracy, in preparation for the darker evenings and regular listening.

The Wireless World Baby Superhet, which has met with such success as an A.C. mains receiver, will be described as a Battery Model, in which form it is likely to have a particular appeal to all those who are interested in superheterodyne performance but have hitherto been unable to enjoy it in the absence of an electric mains supply.

With next week's issue it will be our endeavour to bring *The Wireless World* to the notice of a very large circle so that, as the demand is likely to be very great, we may remind all regular readers to order their copies in advance.

A Novel Argument.

Interference by Tramways.

FACED with the undeniable fact that the Corporation Tramways interfere with broadcast reception, the Parliamentary Committee of the Sheffield City Council has come to the regrettable decision not to recommend the framing of regulations to check the trouble. A feature of the evidence placed before the Committee was the novel argument put forward by the general manager of the Tramways—an argument which demands an instant reply on behalf of all wireless users. The manager pleaded that because the Tramways were first-comers, those interested in radio should bear the financial responsibility for all safeguards necessary to ensure trouble-free reception. He computed that the cost of equipping tramcars with eliminating coils would exceed £3,000. After digesting the evidence the Committee concluded that "it would not be wise for the Council at present to make regulations."

In thus disclaiming responsibility, the Council, we feel, fails in its obligations to the citizens of Sheffield, and we warmly endorse the point of view put forward by Councillor F. Lloyd, who expressed the opinion that the Council had a moral responsibility to protect the local amenities.

If a "firstcomer" had unbounded opportunities to create a nuisance in perpetuity, regardless of all who follow, life would be insupportable.

The Diode Quality

Four

A Battery-fed Receiver with
Distortionless Detection.

By
H. F. SMITH.

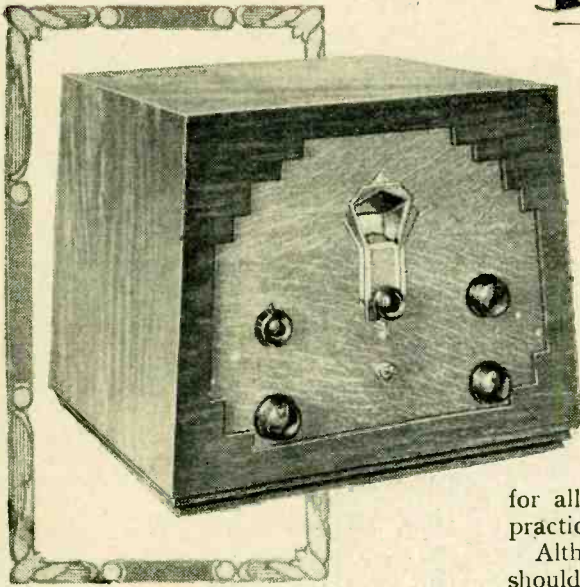

IT is rather surprising that the diode detector, in its latest form, has not, so far, enjoyed a great measure of popularity. Designers of commercial receivers have to work under more or less artificial restrictions, and to them the need for an extra valve—the one real disadvantage of this method of detection—is often a serious matter. But valves are now much less expensive, and amateurs are not subjected to the same hampering limitations; they at least might have been expected to seize with greater avidity upon anything promising a better all-round performance and particularly improved quality of reproduction.

It is not necessary to go over ground that has already been so well covered by Mr. H. L. Kirke, who has made the subject of diode detection particularly his own; his articles, in which the advantages of this method were dealt with at length, appeared in *The Wireless World* of February 3rd and April 20th, 1932. Perhaps one of the reasons why the modern diode is unpopular is that it is confused with its predecessor, the "neutralised space charge" diode, which needed a large input, imposed heavy damping, with consequent loss of sensitivity, and especially selectivity, and which needed a polarising current; altogether, it was not a very practical arrangement.

The Two-electrode Detector.

Unlike the grid or power-grid detector the modern diode imposes a very light load on the preceding circuit, and, as a load resistance of high value may—or, rather, must—be used, its sensitivity is good. Perhaps most important of all, its input capacity remains constant, and so gang-controlled circuits may be accurately aligned. This advantage is shared by the screen-grid detector valve, but its operating conditions are very much more critical. Practically speaking, the diode detector may be regarded as distortionless

for all reasonably large inputs, and it is practically impossible to overload it.

Although an extra valve is necessary, it should be remembered that the diode detector consumes no anode current whatever, and that its use generally enables us to effect economies elsewhere. Almost any type of valve will do for the purpose, and its filament current is negligible.

The use of diode detection is not confined to any special type of set, nor is it likely to introduce any untoward complications. Rather the reverse; the absence of an anode connection tends to confer immunity from undesirable inter-stage reaction. The present set, in which diode detection is exemplified, employs a total of four valves, but it should properly be compared with the conventional three-valve "H.F." set. It may therefore be conservatively described as of the medium-range type, which means that it

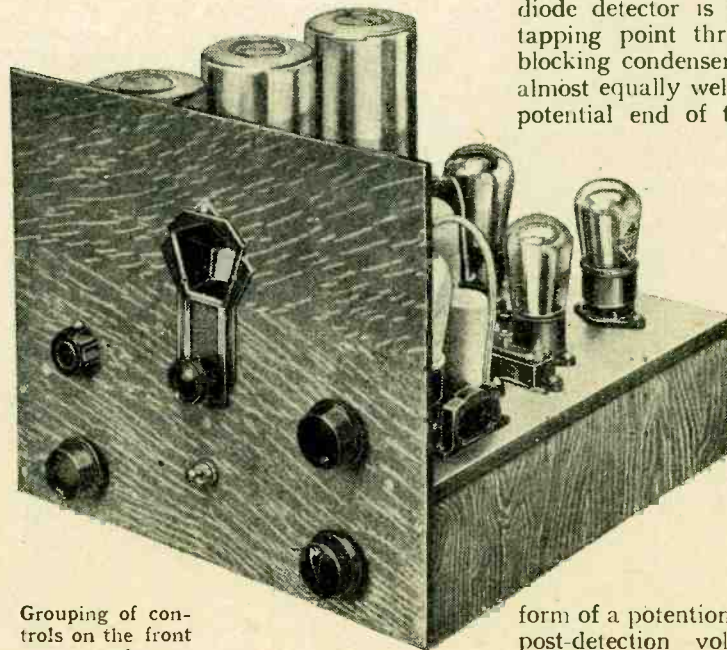

Grouping of controls on the front panel.

is quite suitable for long-distance reception when conditions are reasonably good. Before discussing details it will be as well to run through the circuit diagram, and to explain its main features.

A band-pass filter is interposed between

FEATURES.

General.—A medium-range four-valve set for use with an external aerial. Designed for battery operation.

Circuit.—Two-circuit input filter; one variable-mu H.F. valve coupled by tuned grid circuit to a diode detector. Rectified output fed direct to an intermediate L.F. amplifier, which is coupled to a triode output valve by a parallel-fed tone-correcting transformer. Automatic bias.

Controls.—(1) Single-dial control of three tuned circuits. (2) Sensitivity control. (3) L.F. magnification control. (4) Tone regulator. (5) Wave-range switch. (6) On-off switch.

the aerial and the variable-mu H.F. valve; coupling between the component circuits is effected by the combined actions of condensers C and C₄, which, in conjunction, provide sensibly constant coupling over the waveband. Variable automatic bias for the H.F. valve is derived, through the decoupling resistance R, from the voltage developed across the potentiometer R₁, which is in shunt with the main bias resistance R₂.

Choke-fed tuned-grid coupling is employed in the H.F. stage, the anode connection to the tuned-grid coil being made to a tapping point and thus converting it into a form of auto-transformer. The diode detector is similarly joined to the tapping point through its semi-variable blocking condenser C₃, although it might almost equally well be joined to the high-potential end of the tuned circuit. By adopting this method of connection to the detector, the effective value of incidental capacity thrown across the tuned circuit is reduced, and consequently the waverange covered by the tuning system is extended.

There is nothing unusual about the connections of the diode, except that its load resistance R₃ is in the

form of a potentiometer, and thus provides post-detection volume control; this is additional to the sensitivity control.

In the anode circuit of the L.F. valve, to the grid of which the diode output is directly passed, there is a simple H.F. filter designed to dispose of any residue of H.F. current that may pass the detector filter consisting of "H.F. Choke₂" and C₅.

The Diode Quality Four.—

Coupling between the L.F. valve and the output stage is effected by a Multitone transformer, of which the frequency characteristics may be regulated by means of a potentiometer R_5 . Bias voltage for the output valve is developed across the resistance R_8 , inserted in the negative H.T. lead, and is fed through the decoupling resistance R_6 .

The inclusion of provision for tone correction in the L.F. amplifier needs a word of explanation. In order to attain maximum sensitivity and selectivity the coupling between the elements of the band-pass filter is arranged to give single-peaked tuning over the majority of both wavebands. Again, the damping imposed on the tuned intervalve coupling by the diode is unusually light, and the net result is that a certain amount of high-note loss takes place in the tuned circuits. This would not generally be considered serious, but as the highest possible standard of reproduction was aimed at, it was considered worth while to provide means of compensation. In practice, this scheme is highly successful; drastic correction is not necessary, and one merely sets the controlling potentiometer slightly towards the "bright" side.

The need for both pre- and post-detection

volume controls may not be immediately evident until it is remembered that the diode gives of its best with a reasonably large input. By reducing the amount of

then the sensitivity control should be advanced until the output valve is fully loaded. Operated in this way, detection can be assumed to be distortionless under average working conditions. For long-distance reception the slider of the potentiometer R_3 may have to be in contact with the high-potential end of the resistance element in order to get sufficient signal strength; rectification will then be rather less perfect.

Another advantage of the double volume control is that it is not necessary to make extravagant provision for the application of an extremely high-negative voltage to the H.F. grid; the strongest local signals likely to be encountered can be reduced virtually to inaudibility by setting the "H.F." control at minimum, and then operating the L.F. potentiometer. This method of control is quite unobjectionable from the point of view of quality.

Constructionally, there is nothing unusual about the receiver, and it is built up in the style which has lately proved popular among *The Wireless World* readers. The majority of components are mounted inside and on the top of a shallow inverted box, made of ply-wood, measuring 12in. square \times 3 $\frac{1}{2}$ in. deep. The top of this box is shielded by means of a sheet of "Konductite" metallic paper pasted to its sur-

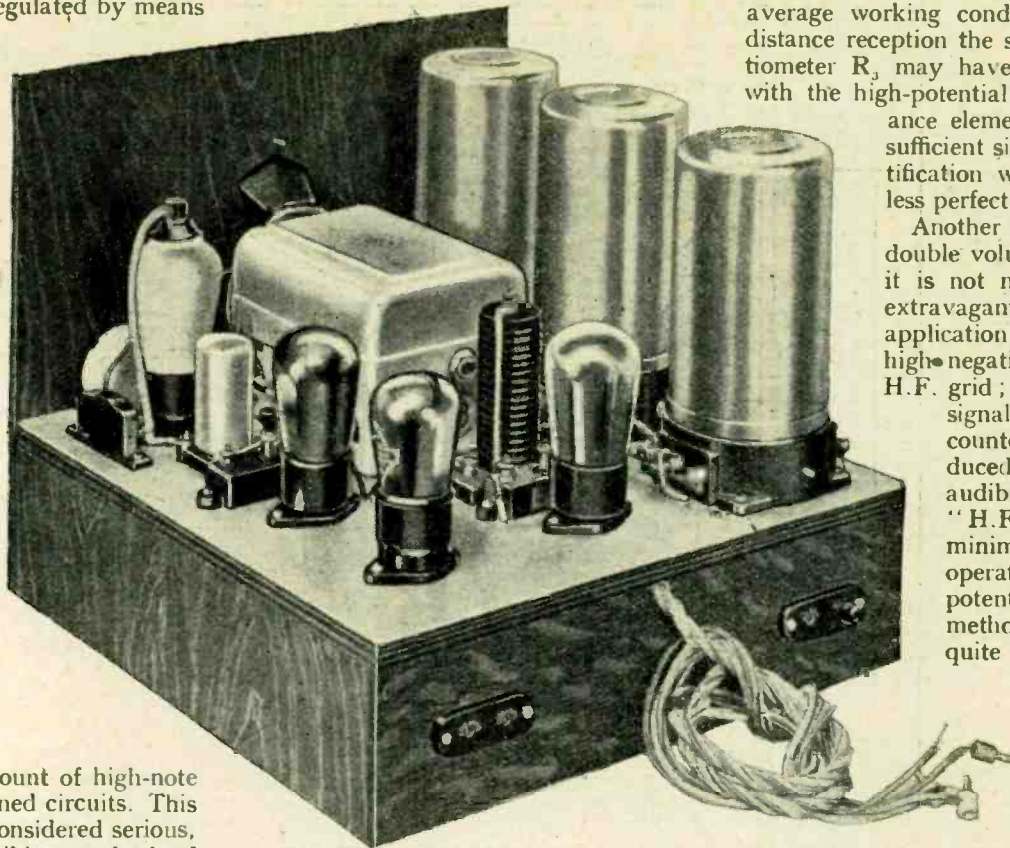

Layout of components on the upper side of the baseboard.

L.F. magnification the post-detection control could be avoided, but the set would then be less flexible; as it is, the post-detection potentiometer slider should be set at about the middle of its travel, and

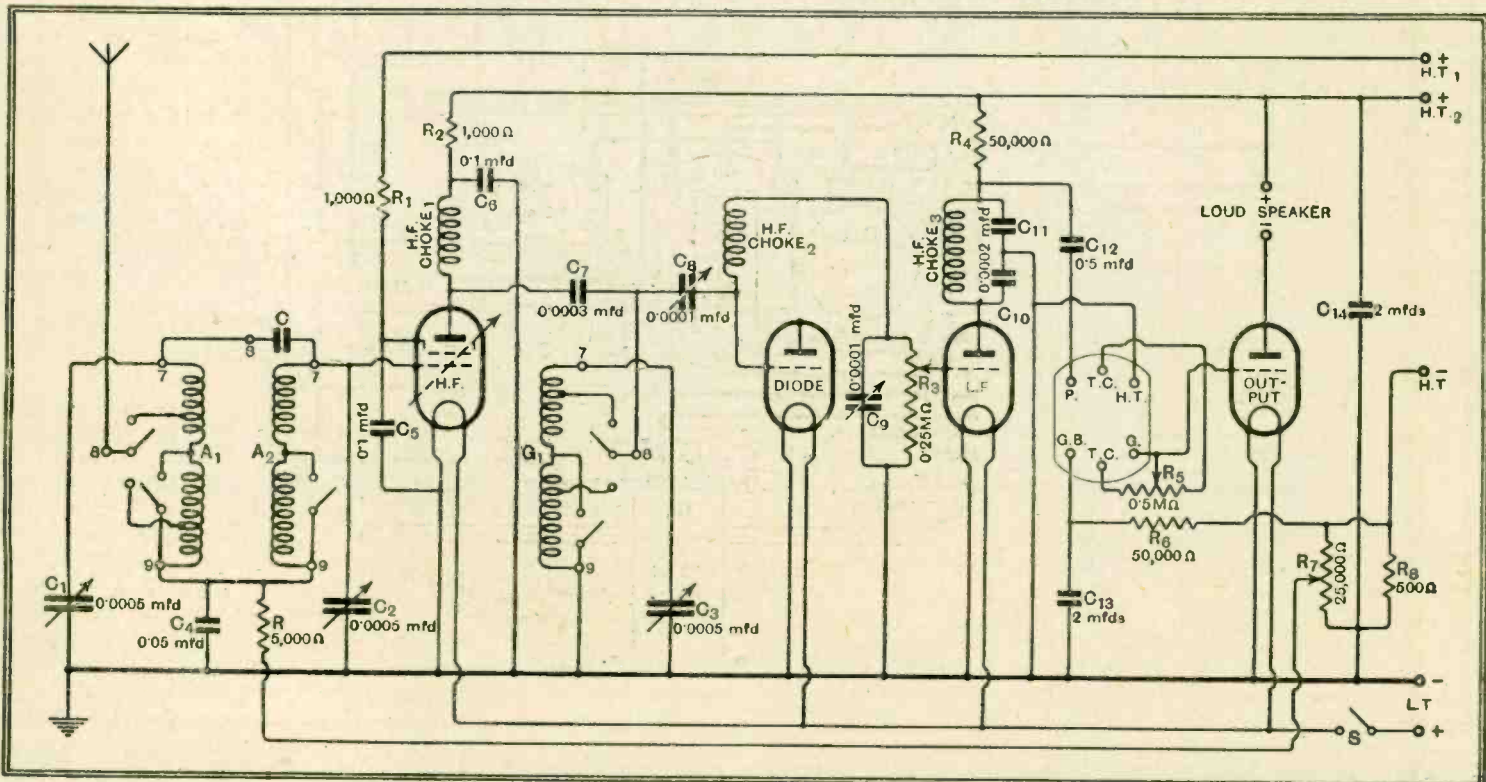

Fig. 1.—The complete circuit diagram. The small, coupling condenser C is included in the filter secondary coil assembly.

COMBINED LAYOUT AND WIRING PLAN, WITH LEADING DIMENSIONS.

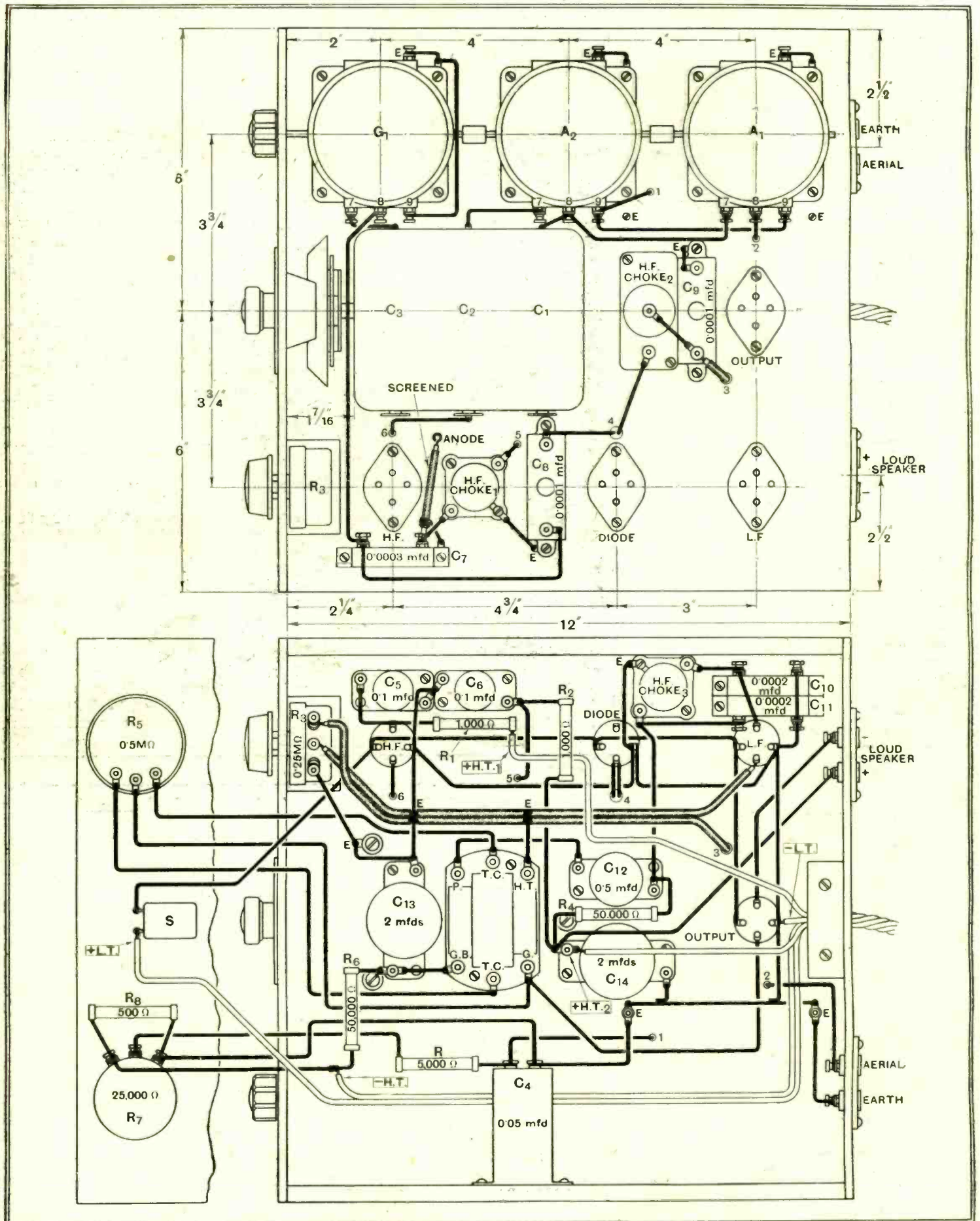

Fig. 2.—The baseboard is cut away to accommodate the potentiometer R₃, which is mounted on the same level as the waverange switch. Earthing connections on the metal screen are marked E.

The Diode Quality Four.—
face. A thin plywood front panel, measuring 12in. wide by 10in. in height, forms the front side of the box, and also serves as a support for the control components.

By using sub-baseboard valve-holders most of the wiring can be concentrated in the base compartment. Almost all the terminals are accessible, but there is unavoidably a rather small clearance between the tuning coils and the variable condenser assembly; consequently, two or three of the leads should be put on before all the parts are assembled in position. In mounting the coils a certain amount of care should be taken to see that they are accurately aligned, so that the ganged wavechange switch may operate smoothly; to reduce the overall space occupied by the three coils it is necessary to shorten the projecting ends of the switch control rods.

Although there is a good deal of latitude in construction, there are a few points to which attention should be drawn. First, it should be remembered that the coils employed are of rather lower H.F. resistance than usual, and further, that here we cannot depend upon the damping of a grid circuit detector to stabilise the H.F. stage; as a consequence, care should be taken to reduce stray couplings between plate and grid circuits, and so the "run" of the H.F. wiring should be arranged pretty much as in the original set. With the same object, it is desirable to "earth" each rotor section of the variable condenser directly to the metal screen at an adjacent point by means of leads taken from the soldering tags provided. Similarly, the metal frame of the condenser should also be in contact with the baseboard screen. As an extra precaution the high potential leads which run to the potentiometer R_3 are carried in low-capacity shielded sleeving of which the metallic covering is, of course, earthed. The anode connection to the H.F. valve is similarly treated.

In the "List of Parts" there will be found the types and makes of valves used

in the original set. With regard to the H.F. amplifier, a variable-mu valve is clearly essential if proper use is to be made of its sensitivity control, but almost any general-purpose valve works well as a detector. As an L.F. amplifier, a good "L" class is best, although a valve of somewhat higher impedance may be used. The output valve suggested is both

economical and efficient, but where a greater anode current than about 12 milliamps. can be provided a type such as the P.M.202 is naturally preferable, as it provides greater undistorted output. The use of this type of valve will involve the fitting of a bias resistor (R_5) of 600 ohms.

Initial adjustment of the receiver is practically confined to setting the trim-

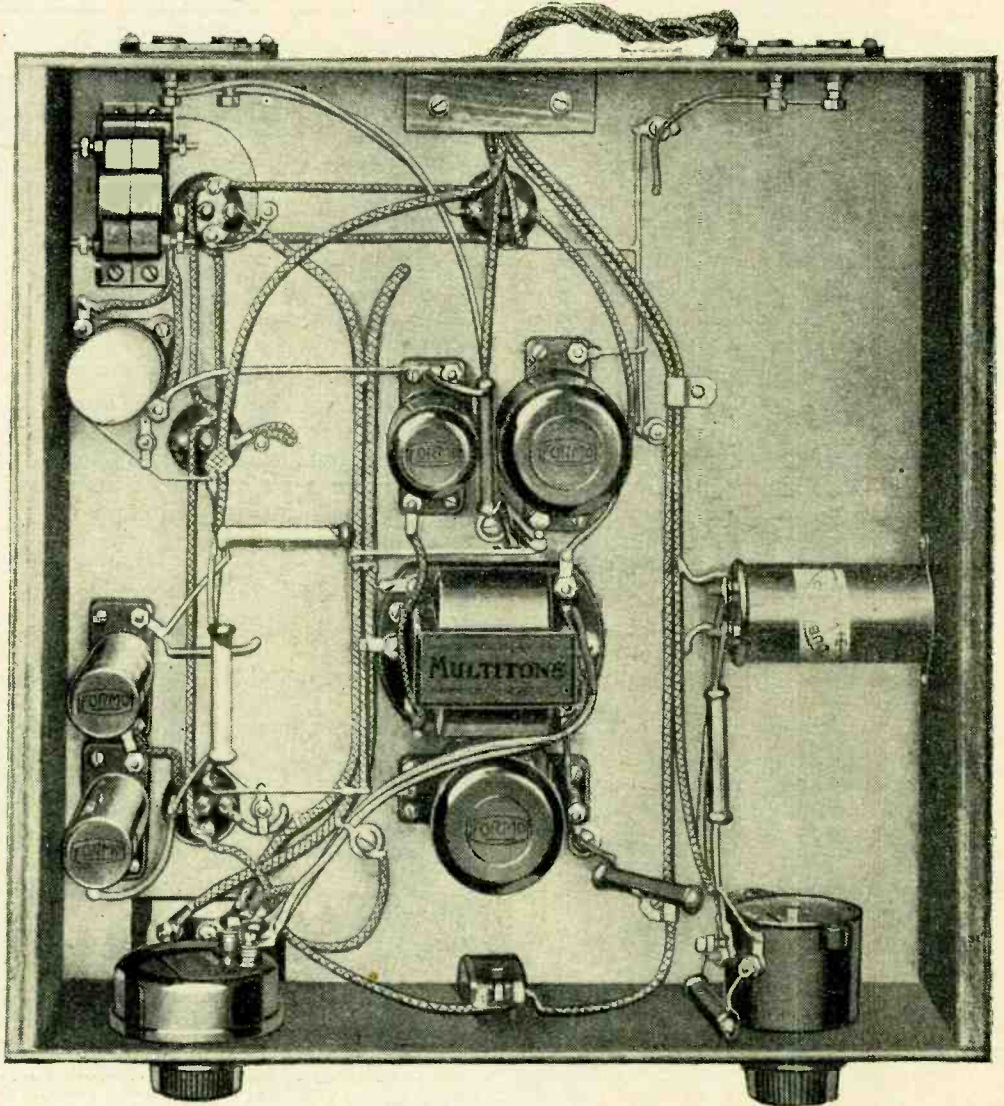

Arrangement of components in the base compartment. The various fixed resistors are supported by their wiring.

LIST OF PARTS REQUIRED.

After the particular make of component used in the original model, suitable alternative products are given in some instances.

- | | |
|---|---|
| 1 3-gang condenser, 0.0005 mfd.
(J.B. "Nugang" No. 2054) | 1 H.F. choke
Kinva, McMichael, R.I. "Quad," (Lewcos No. 11) |
| 1 Disc drive for above
Ormond, Polar, Radiophone, Utility. (J.B. No. 2062) | 1 Potentiometer, 0.25 megohm (Wearite Q.21) |
| 1 Set of 3 screened coils
British General, Colvern, Formo, Lissen, Telsen, Wearite. (Tunewell; A1, A2, C1) | 1 Potentiometer, 25,000 ohms
Colvern, Lewcos, Watmel. (Wearite Q.34) |
| 4 4-pin valve holders for chassis mounting
Bulgin, Clix, Eddystone. (W.B. Skeleton type) | 2 Semi-variable condensers, 0.0001 mfd. (Formo Type F)
Polar, R.I., Telsen. |
| 1 Resistor, 500 ohms, 1 watt (Claude Lyons) | 1 On-off switch
Bulgin, Claude Lyons, Radiophone. (Igranic "Midget") |
| 2 Resistors, 1,000 ohms, 1 watt (Claude Lyons) | 2 Twin plug supports, aerial, earth, loud speaker
Belling-Lee, Goltone, Junit, Lissen. (Bulgin P.30) |
| 1 Resistor, 5,000 ohms, 1 watt (Claude Lyons) | 1 Battery cable, 5-way
Belling-Lee, Harbros, Lewcos, Concord. (Bulgin B.C.3) |
| 2 Resistors, 50,000 ohms, 1 watt
Bulgin, Colvern, Dubilier, Erie, Loewe, Sovereign, Varley, Watmel. (Claude Lyons) | 2 Fixed condensers, 0.0002 mfd. (Telsen No. 241) |
| 1 Tone-control transformer with potentiometer
Varley "Reclatone." (Multitone 4 : 1) | 1 Fixed condenser, 0.0003 mfd. (Telsen No. 242)
Dubilier, Formo, Graham Farish, T.C.C. |
| 1 Fixed condenser, 0.05 mfd., non inductive
(Dubilier Type No. 9200) | 1 Easeboard, 12in. x 12in. |
| 2 Fixed condensers, 0.1 mfd. (Formo Type 34C) | 1 Sheet Metallic Paper. (C.A.C. "Konduktite") |
| 2 Fixed condensers, 2 mfd. (Formo Type 38C) | 1 Length screened sleeving (Goltone) |
| 1 Fixed condenser, 0.5 mfd. (Formo Type 36C)
Dubilier, Ferranti, Peak, Savage, T.C.C., Telsen. | 6 yds. connecting wire
Harbros, Lewcos. (Concord "Slipquik") |
| 2 H.F. chokes, screened (Wearite H.F.P.) | Screws, wood, etc. |

ming condensers; the use of the controls regulating L.F. magnification and tone has already been touched upon. To conserve anode current, the H.F. bias potentiometer should never be quite at zero voltage; one's aim should be to work with as much negative bias as possible, consistent with other requirements. As a first approximation, the semi-variable condenser C_5 may be set at half-capacity; C_5 may be almost at maximum, as any high-note loss introduced by this capacity may be corrected by R_5 .

The set lends itself to mounting in practically any type of container; the cabinet illustrated was made for the writer by the firm of Chas. A. Osborn.

This receiver, with others recently described in "The Wireless World," will be available for examination on Stand No. 14 at the Manchester Radio Show.

Valves: 1 Cossor 220 V.S.G.; 1 Mullard PM1 H.L.; 1 Cossor 210 L.F.; 1 Mullard PM2A (or PM202); or types of other make with similar characteristics.
Approximate cost, less valves and cabinet: £6 17s. 6d.

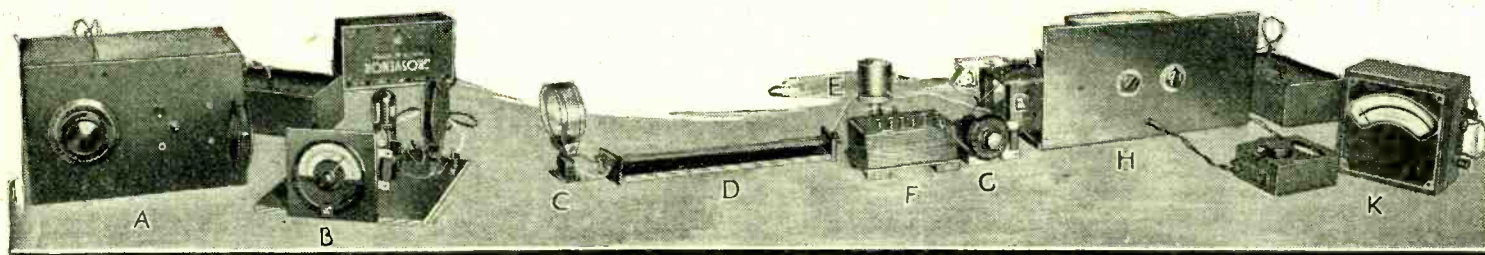

The New Tuning Coils.

Part I.—Litz in a Pill-box.

By A. L. M. SOWERBY, M.Sc.

IN the issue of this journal dated September 16th there appeared the first announcement in this country of an entirely new type of tuning coil the novelty of which depends upon the introduction of an iron core of low high-frequency losses.

Iron cores in high-frequency circuits are not entirely new—they have been used extensively in the past in the intermediate-

The equipment used in measuring coil efficiency is shown in the title illustration and a key to each piece of apparatus is given below.

A. Wavemeter for checking wavelength. B. Oscillator: circuit as in Fig. 2. C. two-turn pick-up coil. D. Bifilar connecting leads, 1 metre long. E. Ferrocart coil being measured. F. High-frequency resistance box. G. Tuning condenser—very slow motion. H. Valve voltmeter. K. Meters attached to H.

frequency transformers of the early super-heterodynes, and were even common in America at one time in the so-called "aperiodic" high-frequency transformers used for amplification on the medium-wave band.

In these early iron-cored coils the magnetic material commonly used was iron dust or filings embedded in wax in such a way that each particle of iron was insulated from its neighbours. Eddy currents, in consequence, were very restricted in their paths, so that the losses, appearing on measurement as increased high-frequency resistance, were not unduly high. Nevertheless, it was found that the losses introduced by the magnetic core were considerably greater than the saving effected in copper losses by the ability to attain the desired inductance with fewer than the usual number of turns of wire.

The use of iron was therefore never extensive, and it has long been common knowledge that a coil wound on a core of air—that is to say, on an insulating and non-magnetic former—must be our choice if the highest efficiency is required.

The new coils, wound on a former of the new magnetic material "Ferrocart," have now arrived to challenge this ac-

cepted dogma of the coil designer. As an examination of the measurements given later will show, this dogma is not merely challenged but completely overthrown. How far this improvement is due to the use of one or other of the new high-permeability alloys is not at present clear, since data as to the materials used in the core and the method of manufacture are not available at the time of writing. It would at least appear possible that much of the advance made is due to the choice of a ring-shaped former, which provides a closed magnetic circuit.

The older iron-cored coils were generally wound round a straight rod of the wax-iron compound, so that the magnetic path, as indicated in Fig. 1, still included a good deal more air than iron. With the ring formation of the new Ferrocart coils the construction is equivalent to that which the coil of Fig. 1 would assume if the air-gap were closed by bending the coil round into a circle until the two ends of the core met. The losses in the iron, one would imagine, would not be greatly increased by this imaginary bending, but the elimination of the air-gap would raise enormously the permeability of the magnetic path as a whole, for it would now lie entirely through the core. Compensa-

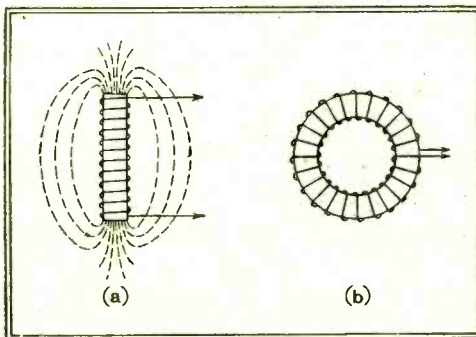

Fig. 1.—(a) Lines of force surrounding a coil wound on an open iron core. Observe that the bulk of the magnetic path lies in air. (b) If the core is bent round to make a closed ring, the flux passes practically completely through the core. There is now no air path.

tion for the greatly increased inductance that would follow upon this would then have to be made by removing as many turns as might be necessary to bring it

THE new tuning coils with iron cores, first described in "The Wireless World" on September 16th, have created so much interest that a further article giving practical measurements of their efficiency will, we feel sure, be welcomed by our readers. The benefits of increased coil efficiency may be realised in practice as greater amplification and better selectivity; the former may often be unimportant, but the latter is always needed, even in a super-heterodyne. In any receiver the new coils permit the physical dimensions to be reduced.

down again to the original value, and this would naturally result in decreasing the losses by cutting down the resistance of the wire. The result would be a coil indistinguishable in appearance from the Ferrocart type of construction.

Magnetic Field Reduced.

In the Ferrocart coil the inductance is obtained with considerably fewer turns than would be necessary if an air core were used, so that it becomes possible to make the coils quite small while still retaining thick wire to ensure low copper losses. An even greater contribution to compactness is made possible by the fact that the path of the magnetic flux is almost entirely confined to the core itself. In the ordinary open-core solenoid coil, which is at present the standard type of medium-wave inductance, a screen round the coil is necessary to prevent the magnetic field, which spreads out over a relatively enormous space, from linking with the other coils in the receiver and so causing instability. With a winding of toroidal type this field is in any case restricted very considerably indeed, even though no iron is present to guide the flux, but when, as in the Ferrocart coils, a toroidal winding is combined with a closed iron core, the field is reduced to extremely small proportions. Crude but convincing proof of this was had by connecting an unscreened Ferrocart coil in a tuned circuit attached to a Moullin voltmeter, and bringing a moderately powerful oscillator near to the coil. At about three inches separation a small deflection was obtained, showing that the coil, or perhaps the wires leading to it, were pick-

The New Tuning Coils.—

ing up the signal. But, on substituting an ordinary solenoid of equivalent efficiency for the iron-core coil, the pointer of the valve voltmeter ran off the scale when there was still a separation of nearly three feet between it and the oscillator.

The fact that signals can be picked up, even if only with difficulty, by Ferrocart coils indicates that it will in practice be desirable to surround them with screening boxes if more than one coil is to be used in a receiver. This will be especially necessary in view of their low resistance, which implies that they will oscillate even if the amount of energy fed into them is but small.

Close Screening Possible.

With the ordinary type of coil it is found necessary to keep the screening box well away from the windings in order that losses due to currents set up in the screening box by the action of the magnetic field shall be kept reasonably small. With the new coils the very restricted field implies that the screening box may be brought very near to the coil without introducing more than trifling losses. Making a wild guess for the sake of a concrete illustration, it would not be too unreasonable to suppose that a screen surrounding a Ferrocart coil at a distance of one-eighth of an inch might be in as weak a magnetic field as a screen surrounding an ordinary solenoid at a distance of five or six inches. We see, then, that the new coil is not only compact by virtue of its construction, but lends itself even more strikingly to practical compactness in a set by permitting itself to be screened in a box only just large enough to hold it without losing any noticeable efficiency through the extreme nearness of the screen to the windings.

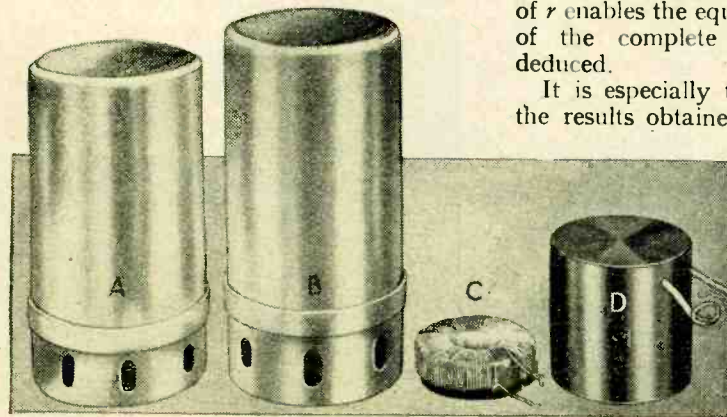

Two typical modern commercial screened coils (A and B) photographed alongside two of the new Ferrocart coils (C and D).

Two Ferrocart coils have been in the writer's possession long enough for a fairly complete examination of their electrical properties to be made. Of these one was wound with solid wire on a small ring-shaped former of the magnetic material, and was unscreened, while the other was wound on a deeper former with thick multi-strand, high-frequency cable, and was enclosed in a screening box 2 in. in diameter and about 2 in. high.

The solid-wire coil had an inductance of 173 microhenrys, and was wound with about 100 turns of wire of a thickness corresponding roughly to 26 S.W.G., while the screened coil had an inductance of 155 microhenrys, and was wound with sixty turns of a Litzendraht made up of three cables each consisting of twenty strands of wire which appeared to be about equal to 42 S.W.G. There were thus sixty strands in all. The insulation between strands and cables was enamel, though the whole was covered heavily with silk to prevent mechanical damage. The vertical side of the screening box was only about 2 mm. away from the outside of the winding, though greater spacing was allowed on the flat sides of the toroid.

These two coils, together with others of more usual type, were examined for high-frequency resistance in the circuit shown diagrammatically in Fig. 2. The oscillator was set going at the wavelength for which the measurement was required, and to its coil was coupled L_1 , a short-wave coil of two turns. This was joined by a pair of parallel wires one metre long and 25 mm. apart to the tuned circuit proper, consisting of L_2 , the coil under examination, the tuning condenser C , and the interchangeable high-frequency resistors indicated at r . A valve voltmeter was connected across the tuning condenser for reading the voltages developed at resonance. Comparison of the voltages obtained for different values of r enables the equivalent series resistance of the complete tuned circuit to be deduced.

It is especially to be observed that all the results obtained in this way refer to the actual tuned circuit built up, and include dielectric losses in the tuning condenser, and the valve voltmeter, together with the series losses due to the coupling coil, the metre-long bifilar leads, and all connecting wires in the tuned circuit itself.

In order that differences between coils might be shown up as clearly as possible all these various sources of additional loss were kept very low, and it is especially to be noted that it would be quite impossible to keep the incidental losses in any practicable receiver as low as they were made in this experimental circuit. Such differences as the measurements show between one coil and another are therefore considerably accentuated as compared

with conditions in a receiver, especially at the lowest wavelengths, where the dielectric losses inseparable from valve-holders, valve-bases, and other such components are most effective in lowering the dynamic resistance.

With these preliminary warnings against accepting the figures that are to follow as realisable in a receiver, the results obtained may be quoted.

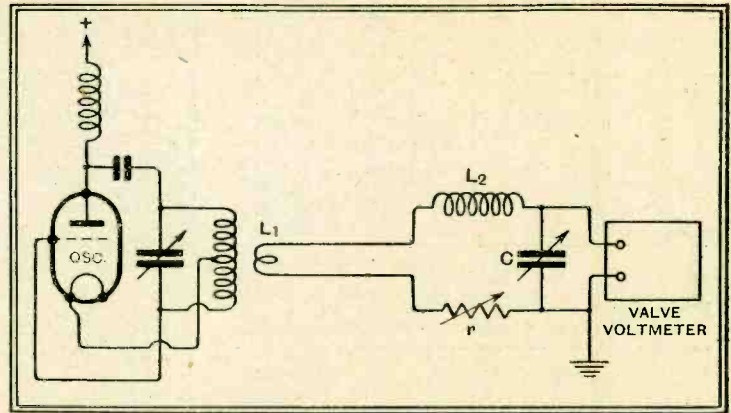

Fig. 2.—Circuit used for measurement of high-frequency resistance. The coil under examination is L_2 .

Tables I and II give the characteristics of two typical screened coils wound on 1 1/4 in. formers and enclosed in screening-boxes about 2 1/2 in. in diameter.

Tables III and IV give the same information for the two Ferrocart coils, C being the smaller coil, unscreened and wound with solid wire, while D is the larger coil, wound with Litzendraht and screened.

Tables V and VI refer to two 3 in. coils wound with 27/42 Litzendraht on paxolin and ebonite formers respectively; these were standard *Wireless World* coils,

TABLE I.

A.—Commercial Screened Coil, 1 1/4-in. former, 2 1/2-in. screen. Inductance 175 microhenrys.

Wavelength, Metres.	Equivalent Series Resistance r , Ohms.	Magnification m .	Dynamic Resistance R , Ohms.
200	18.75	87.5	145,000
225	15.4	95.2	139,000
250	13.12	100.5	133,500
300	10.22	107.2	118,000
350	8.55	110.3	104,000
400	7.44	111.0	91,000
450	6.70	109.2	80,000
500	6.13	107.5	71,000
550	5.71	104.9	63,000

TABLE II.

B.—Commercial Screened Coil, 1 1/4-in. former, 2 1/2-in. screen. Inductance 155 microhenrys.

Wavelength, Metres.	Equivalent Series Resistance r , Ohms.	Magnification m .	Dynamic Resistance R , Ohms.
200	13.89	105.2	154,000
225	11.55	112.4	146,000
250	10.02	116.6	136,000
300	8.25	118.1	115,000
350	6.94	120.7	100,000
400	6.16	118.5	86,500
450	5.64	115.1	74,500
500	5.24	111.5	65,000
520	5.07	110.8	62,000

The New Tuning Coils.— as used in many constructional receivers described between 1926 and 1929, and probably represent the most efficient type of inductance ever used in sets.

TABLE III.

C.—Small Ferrocort coil, unscreened, wound with solid wire. Inductance 173 microhenrys.

Wavelength. Metres.	Equivalent Series Resistance r. Ohms.	Magnification m.	Dynamic Resistance R. Ohms.
200	22.5	72.5	118,000
225	16.15	90.0	130,000
250	12.28	106.2	138,000
300	8.30	131.0	142,000
350	6.25	149.0	139,000
400	5.00	163.0	134,000
450	4.15	174.5	126,500
500	3.60	181.5	118,000
550	3.22	184.0	109,000

TABLE IV.

D.—Large Ferrocort coil, screened, wound with 60-strand Litz. Inductance 155 microhenrys.

Wavelength. Metres.	Equivalent Series Resistance r. Ohms.	Magnification m.	Dynamic Resistance R. Ohms.
200	13.87	105.0	153,000
225	10.20	127.2	165,000
250	7.83	149.5	174,000
300	5.16	188.5	184,000
350	3.83	218.0	182,000
400	3.01	242.5	177,000
450	2.48	262.0	170,000
500	2.14	273.5	160,000
525	2.01	277.0	154,000

TABLE V.

E.—Coil of 27/42 Litz, on 3-in. paxolin former. Inductance 289 microhenrys.

Wavelength. Metres.	Equivalent Series Resistance r. Ohms.	Magnification m.	Dynamic Resistance R. Ohms.
200	27.9	97.7	266,000
225	20.15	120.2	290,000
250	15.35	142.0	310,000
300	10.11	179.0	326,000
350	7.33	212.0	330,000
400	5.72	238.0	324,000
450	4.72	256.0	310,000
500	4.05	268.5	293,000
550	3.59	276.0	274,000

TABLE VI.

F.—Coil of 27/42 Litz, on 3-in. ribbed ebonite former. Inductance 277 microhenrys.

Wavelength. Metres.	Equivalent Series Resistance r. Ohms.	Magnification m.	Dynamic Resistance R. Ohms.
200	19.80	132.0	344,000
225	14.23	163.0	378,000
250	11.30	185.0	386,000
300	7.87	221.0	384,000
350	6.00	248.0	370,000
400	4.94	265.0	345,000
450	4.19	277.0	321,000
500	3.69	283.0	295,000
550	3.33	286.0	271,000

In the various tables the column headed "r" gives the equivalent series resistance that was actually measured; the results in the other columns were deduced from this with a knowledge of the inductance of each coil.

(To be concluded.)

IN NEXT WEEK'S ISSUE—

The Wireless World

Battery

Baby Superhet

Constructional Details of an Economical Four-valve Set.

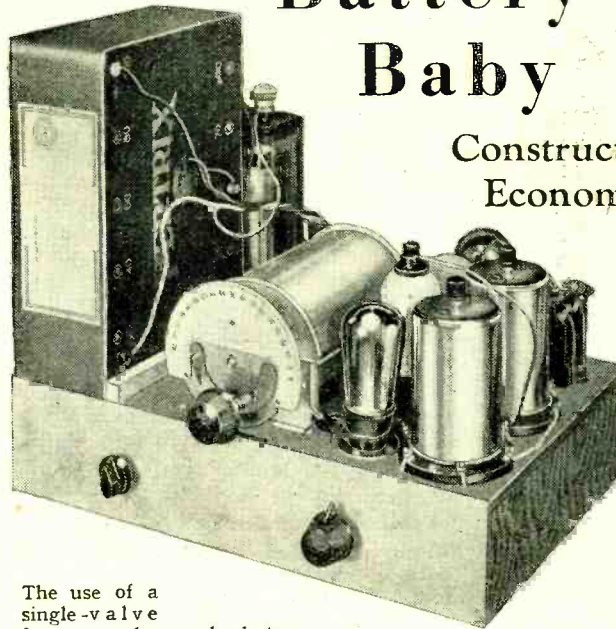

The use of a single-valve frequency changer leads to an economy of components.

THE circuit includes a single-valve pentode frequency changer of non-radiating design, and, to prevent second-channel interference, this is preceded by an inductively coupled band-pass filter. The oscillator and signal-frequency circuits are ganged with the aid of the special shaped-plate type of superheterodyne condenser, and the waveband switching is built-in with the screened coils.

A variable-mu valve is used in the I.F.

stage, and the two band-pass couplings give a total of four I.F. tuned circuits and enable high selectivity to be obtained without serious sideband cutting. A grid second detector is transformer coupled to a pentode output valve, with the aid of which a degree of automatic tone correction is secured. A permanent-magnet moving-coil loud speaker is used and is fitted with the receiver and all batteries into a single cabinet of modest dimensions.

The controls are four in number—the single tuning control, the combined volume control and on-off switch, the wavechange switch, and the "Local-Distance" switch. This latter control is used only for local reception and in conjunction with the volume control proper, which acts by varying the bias on the I.F. stage.

The L.T. current is 0.7 ampere at 2 volts, and the H.T. 10 to 13 mA. at 100 volts, at which there is adequate volume.

LIST OF PARTS REQUIRED.

After the particular make of component used in the original model, suitable alternative products are given in some instances.

- 1 Set of Coils, ganged, for under baseboard mounting (Colvern Type K.B.L.C., with 1 Type K.53)
- 2 I.F. Transformers, 110 kc. (Wearite Type W.W.I.F.) Colvern.
- 5 5-pin valve holders (Clix chassis mounting type) Eddystone, W.B.
- 1 3-gang superhet condenser, 0.0005 mfd. and dial (Utility W.315/3) Polar.
- 1 Semi-fixed condenser, 0.00061/0.0001 mfd. (R.I. "Varicap" No. 2)
- 1 Semi-fixed condenser, 0.0005/0.002 mfd. (R.I. "Varicap" No. 8) Formo, Goltone.
- 4 Fixed condensers, 0.1 mfd. (T.C.C. Type 50)
- 3 Fixed condensers, 1 mfd. (T.C.C. Type 50)
- 1 Fixed condenser, 0.0001 mfd. (T.C.C. Type 34)
- 1 Fixed condenser, 0.005 mfd. (T.C.C. Type 34) Dubilier, Ferranti, Formo, Graham Farish, Peak, Savage, Teisen.
- 1 Metallised resistance, 1,000 ohms, 1 watt (Dubilier)
- 2 Metallised resistances, 20,000 ohms, 1 watt (Dubilier)
- 2 Metallised resistances, 100 ohms, 1 watt (Dubilier)
- 1 Metallised resistance, 250,000 ohms, 1 watt (Dubilier)
- 1 Metallised resistance, 100,000 ohms, 1 watt (Dubilier) Claude Lyons.
- 1 5-way insulated connector (Wilburn)
- 1 Wire-wound volume control potentiometer, 25,000 ohms, with mains switch (Wearite Type Q.V.C. and C.42)
- 1 L.F. Transformer, 5:1 (Varley "Nictet" D.P.22)
- 2 Ebonite shrouded terminals (Belling-Lee Type "B") Clix, Ealex, Igranite.
- 1 5-pin plug (Bulgin P.3)
- 1 Toggle Q.M.B. Switch (British Radiophone No. 407) Bulgin, Igranite, Claude Lyons.
- 1 5-way battery cable, with plugs and spade ends (Concord) Belling-Lee, Bulgin, Harbros, Lewcos.
- 1 pair G.B. battery clips (Bulgin No. 4) Burton.

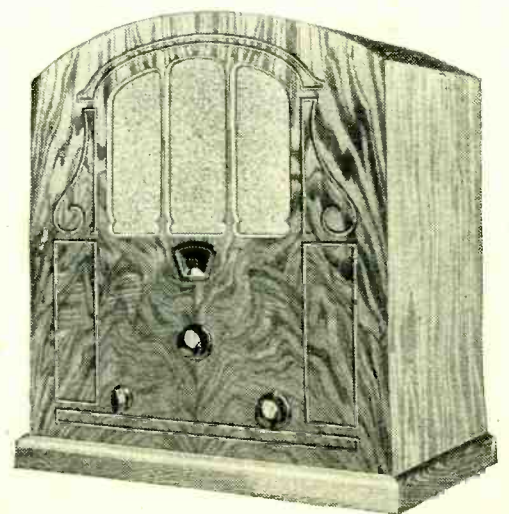

- 4 Wander plugs, G.B.+ , G.B.-1, G.B.-2, G.B.-3 (Clix Type "B") Belling-Lee, Ealex, Gripso, Lisenin.
- H.T. battery, 100 volts (Pertrix No. 298)
- G.B. battery, 15 volts. (Pertrix No. 262)
- L.T. accumulator, 2 volts (Pertrix P.X.G.2)
- Permanent magnet speaker, with pentode transformer (R. & A. "Challenger") Magnavox, Rola
- Cabinet (Camco "Empire")
- 1 Plymax base, 15-15/16in. by 10in. by 3/4in.; 2 pieces 3/4in. plywood, 9-11/16in. by 3in.; 1 piece 3/4in. plywood, 15-15/16in. by 3in.; 1 piece 16-gauge aluminium, 15-15/16in. by 3/4in. (Peto-Scott)
- Wood, screws, 2 ozs. No. 20 tinned copper wire, systoflex, etc.
- Valves: 2 Mazda Pen. 220A., with 5-pin bases: 1 Marconi HL2; 1 Marconi VS2.

UNBIASED

By
FREE GRID.

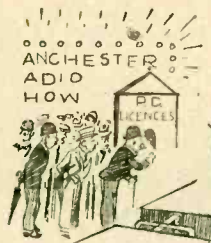

The fifth-millionth?



All Licences, Please!

I SEE that licences are nearing the five-million mark, and that it is hoped to sell the fifth-millionth licence at Manchester. It would be an excellent thing, in my opinion, if the Postmaster-General could be persuaded to be present in person at the Exhibition to sell this licence, or, rather, to give it away. My suggested policy of making this licence free would probably cause a large number of visitors from the other side of the Tweed to be attracted. In any case, it would have the effect of reducing by one the large number of pirates who visit the Exhibition each year.

Speaking in all seriousness, I think it would be an excellent plan if the Exhibition authorities could arrange that all licences had to be shown before anyone was permitted to enter the show. A handy kiosk for the sale of licences could be established by the Post Office in the vestibule, and it would, I feel sure, do a brisk trade.

I suppose that even then, however, groups of pirates would get together and buy one licence only, before they came to the show, and then state that they were all members of the same family and household, and therefore covered by the one licence.

Translation Howlers.

IT is astonishing how often quite well-informed journals and newspapers come a cropper when attempting to discuss technical terms pertaining to radio. It is difficult to see why this should be so, since excellent dictionaries of technical terms are available, including one recently sponsored by "W.W.," which I would commend to all newspaper editors.

When dealing with a foreign language there is perhaps more excuse for journalists; but I do think that a well-known news agency should do better than to put into the mouth of a well-known French authority the grotesque phrase: "When I think of the buildings which contain hundreds of flats and the number of wireless posts in them, I am terrified."

Surely, even though the news-agency had blundered, the editors of the various national newspapers ought to have been able to translate *postes*.

A Risky Token.

A READER who alleges that I saved him a considerable sum of money by causing him to refrain from purchasing a certain set, he having "read between the lines" in some of my writings a few weeks ago, has caused me some embarrassment and nearly landed me into the hands of the law. It all arose out of a little token of his esteem in the form of a horse-racing tip which he insisted on sending me.

Being entirely ignorant of horse-racing matters I was at first somewhat at a loss to know what to do, but a "horsey" friend whom I consulted said that nothing was easier. All I had to do was to go, shortly before the race, to a certain street which he named and hand my money and the name of the horse to a man whom I should see there. I should then merely have to wait about a few minutes until the race was decided when, so my friend alleged, the man would reappear on the scene and return my money thirtyfold. Such a method of obtaining cash seemed so easy that I there and then resolved to order the parts for a ten-valve radiogram which I have long since been meaning to construct when my financial position became a little easier.

I arrived at the time and place appointed, and sure enough I had no difficulty in spotting my man. With a hearty "There you are, now what about that bet?" I was about to hand over some Treasury notes to him when a shadow loomed up behind us and a policeman with a notebook held at the "ready" demanded our names and addresses.



A shadow loomed up.

Somewhat indignantly I drew out my card case and handed over the necessary piece of pasteboard, and after an insolent remark from the minion of the law to the effect that I should hear more about the matter I took a dignified departure. I learned afterwards that the horse unfortunately lost, and so perhaps it was all for the best, as was also the fact that in my agitation I had given up the card pressed on me at the Manchester Wireless Show by an importunate gentleman who was anxious to sell me an expensive radiogramophone.

Why They Are Disappointed.

I FEEL it is high time I made a protest about the misconception that has arisen concerning the use of two loud speakers instead of one, a practice which is becoming increasingly popular. That such a misconception does exist is amply demonstrated by my post-bag.

The original idea was, of course, put forward by "W.W." years ago in the heyday of moving-iron instruments. Since it was difficult, if not impossible, to get an instrument which did justice to both high and low notes, the idea was to choose and use two loud speakers, one of which specialised in low notes and t'other in soprano shrieks. Similarly, in these days of moving coils which are still far from perfect, it is often possible to get better results by using two.



No improvement.

Where hundreds of people have missed the boat, however, is in thinking that a couple of loud speakers of any old type will do the trick. Many have simply been stringing together two instruments of exactly the same characteristics, and then writing to me, moaning that they do not notice any improvement.

I must therefore make a public request to all those who have written to me on this matter, and that is that they follow the rule which I observe before committing words to paper, namely, THINK.

A Tardy Inventor.

NEWCASTLE-ON-TYNE is the scene of the world's latest epoch-making radio invention. Five years' hard work and experimenting on the part of an inhabitant of Jesmond have borne fruit in the shape of a receiver in which all tuning troubles are obviated by the simple expedient of switching in various circuits pre-tuned to a number of stations. A local newspaper is eloquent over it.

What a pity the hard-working inventor did not happen to glance at *The Wireless World* seven years ago! If he had done so, he would have been rewarded by full constructional details of a receiver strangely reminiscent of the latest wonder, on the invention (?) of which he has been working for the past five years.

Practical HINTS and TIPS.

EVER since *The Wireless World* began, emphasis has been laid by writers in our pages on the need for treating H.F. connecting leads with respect. Those who pay little heed to this advice may—and indeed often do—obtain good results

Preventing H.F. Instability.

But the truth is that although liberties may often be taken with impunity, very few of us can recognise those leads which are and are not of vital importance. Even if we do know, it is not an easy matter to visualise the ill-effects of an improperly made connection, and so it is just as well to play for safety in all cases. Every wire carrying H.F. energy should be regarded as a danger point.

Any serious trouble brought about by lack of care in these matters is likely to manifest itself most obviously in the form of H.F. instability, or uncontrollable self-oscillation as the various circuits are brought into tune with each other. In spite of the excellence of the modern screen-grid valve, with its infinitesimal grid-anode capacity, it is the rule, rather than the exception, for a newly constructed "H.F." set of original design to show signs of instability, which can only be removed by clearing away the source of unwanted inter-circuit coupling which is responsible.

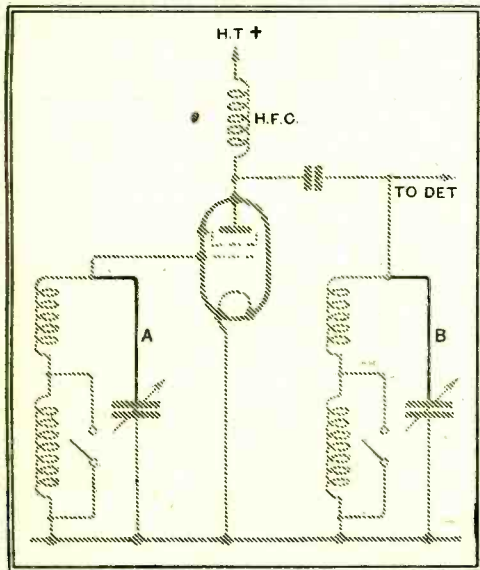

Fig. 1.—Skeleton circuit of a typical H.F. amplifier. Leads A and B correspond with the wires shown in the photograph.

As an example of what to avoid, the accompanying photograph of carelessly made connections to two of the sections of a three-gang condenser may be studied. The condenser was used for tuning quite a straightforward I-V-I set, of which the

AIDS TO BETTER RECEPTION.

part of the circuit in question is shown in Fig. 1, where the condenser leads are in full lines. These wires were running parallel to each other, with a spacing of about $\frac{3}{8}$ in., and it was found that they introduced sufficient anode-grid reaction to produce instability over a good half of the tuning scale. Merely by rearranging the relative positions of these wires, complete stability was attained.

A WORD of warning may be offered to those who use signals from a nearby station as a guide when adjusting the tuning or coupling of a band-pass filter. It is quite possible that in such circumstances an entirely misleading effect

Adjusting Filter Circuits.

may arise; due to detector overloading it may appear that two widely separated tuning humps are produced when actually the resonance curve is of the single-peaked variety. The falling off in signal strength which may occur at the tuning point corresponding to exact resonance is easily confused with the trough of a double-peaked resonance curve.

AS almost every form of manual tone control introduces a loss in amplification, which becomes greater as its effect in changing the frequency characteristics becomes more drastic, it follows that in order to obtain best possible results from

Tone and Volume.

the use of these devices it is desirable to have a satisfactory form of volume control. Most modern sets have a "pre-detection" control whereby input to the detector or to the H.F. valve may be regulated, but if the detector itself is to be operated under the best possible conditions it is often an advantage, when tone control is employed, that means should be provided for varying L.F. amplification as well. This is particularly likely to be true when operation of the tone control introduces a great difference in average magnification.

There is another aspect of the question of tone control and volume to which attention may be drawn. As speech is often transmitted at the same intensity as music, it is generally agreed to be desirable to reduce its relative intensity. Although it may sound like heresy to a certain school of thought to suggest that this may satisfactorily be done by operating the tone control in such a way that the lower register is heavily attenuated, a

good case can be made out for this procedure. The general level of reproduction will be reduced, and almost invariably speech will actually gain in intelligibility by removal of much of the bass.

THAT H.F. currents in the supply mains are a prolific source of mains hum is well known, and it has become the common practice to connect small condensers between mains and earth with the object of reducing the liability of such

Interaction between Mains and Set.

currents to pass through the receiver circuits. An alternative method of preventing so-called modulation hum is to use a mains transformer with an electro-statically screened primary; this practice is becoming increasingly common, as it tends to reduce background noise.

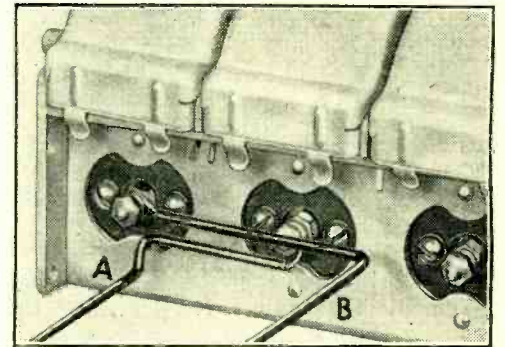

An example of careless wiring. A is a grid lead while B is an anode lead (see Fig. 1).

It is not generally realised, however, that where such a transformer is employed it is essential to avoid stray external couplings between the mains and the receiver, otherwise all the good of the screening may be undone. This was brought home forcibly when using a set with very long mains leads. In a sudden thirst for tidiness, the mains flex lead was wound into a neat coil in the hollow bottom of the receiver cabinet, with the result that terrific modulation hum became evident on switching on the set. Coupling between the receiver chassis and the mains leads was sufficient to transfer the H.F. energy in the mains to the set, and to render the carefully screened primary of the mains transformer of no avail.

In sets in which one pole of the mains is extended inside the receiver chassis to the mains "on-off" switch, there is naturally some coupling between this lead and the receiver circuits. It will often be found, in such cases, that modulation hum may be cured by the simple expedient of reversing the mains plug in its socket.

News of the Week.

Current Events in Brief Review.

Changes at Hilversum.

WE learn that the popular 296-metre broadcasting station at Hilversum is to undergo important technical improvements which should make it still more easily heard in this country. The transmissions from 8 p.m. onwards are now being given with a power of 25 kW.

The Inventors' Chance.

INVENTORS, amateur and professional, get their annual opportunity to display their ideas on Wednesday next, October 5th, when the 8th Annual Exhibition of Inventions will be opened by the Lord Mayor of London, Sir Maurice Jenks, at the Central Hall, Westminster. We learn that there will be exhibits of special radio interest. The exhibition will remain open until October 15th.

Scottish Radio Shows.

OCTOBER 12th has been fixed as the opening day of the Third Scottish National Radio Exhibition, to be held in the Waverley Market, Edinburgh. This exhibition, which has the backing of the Radio Manufacturers' Association, will remain open until October 22nd, and during that period the B.B.C. will co-operate by broadcasting a number of programmes from a model studio.

On Wednesday last the *Glasgow Weekly Herald* opened a Radio Exhibition in St. Andrews Hall, Glasgow. This also contains a B.B.C. model studio designed on modernist lines by a local architect. The closing date is October 8th.

The Power Urge.

LATVIA'S only broadcasting station, the 15 kW transmitter at Riga, will be more widely known in the near future when the power is increased from 15 to 50 kW. in the aerial. The wavelength will probably be raised above 600 metres. The station building and masts have been completed, and it is hoped to begin the new transmissions this winter. The new station will go by the name of "Madona."

Radio Kaunas, another station little known in Western Europe, is only distinguished by the fact that it uses the highest wavelength in the broadcasting list, viz., 1,935 metres. The power is shortly to be increased very considerably.

"Direct Comparison."

IT was a happy thought on the part of E. K. Cole, Ltd., to stage their sensational "direct comparison" show at the Paramount Theatre, Manchester, during the run of the Northern National Radio Exhibition.

The Ekco event opened at the Paramount on Monday last, September 26th, and will continue until the end of the Radio Exhibition on October 8th. The artists participating in person are Miss Elsie Carlisle and Flotsam and Jetsam, with Denis Mayne as *compère*.

As readers know, the demonstration consists of gramophone reproduction, followed by a performance by the same artists over the microphone, and their subsequent appearance in the flesh.

The Tenants Win.

BECAUSE tenants of Liverpool Corporation houses have shown unwillingness to pay 1s. per annum for the "privilege" of erecting poles for wireless aerials, the Housing Committee has decided to recommend that the charge should be discontinued.

"Pirates" must wish that the P.M.G. would show the same leniency.

Blushing Unseen.

CONSTERNATION reigns among listeners in a southern city of France at the discovery that a crowned "Queen of Beauty" is acting as announcer and is reading the late Regional news each evening. This waste of fragrance on the studio air seems to disconcert all those—and they are in the majority—who consider that a broadcast studio is the last place in which to hide the female form and face divine.

Chaos in German Broadcasting?

GERMANY'S zero hour for reorganising the broadcasting system occurs at midnight. The present companies, it will be remembered, have been compelled to relinquish their licences to-day (September 30th), the new State companies taking over control to-morrow. Yet, according to our Berlin correspondent, a hitch is still possible. One rumour has it that the entire reorganisation scheme has been postponed until January 1st; another proclaims that the Ministry of Posts is at loggerheads with the Ministry of the Interior on the appointment of staff. Still a third version says that, as the cost of liquidating the existing companies and forming the new ones would exceed half a million marks, the original companies are to remain.

Meanwhile the great German public tunes in its dance music and still hopes for the best.

That Tax.

THE listeners' tax recently suggested by the French Postmaster-General has had a bad Press, says our Paris correspondent. The distaste of the average French set owner for the payment of anything whatever is paralleled in intensity only by nature's abhorrence of a vacuum. The situation seems to be summed up by a journal which states: "The unfortunate Minister will find nobody to support such a tax, and consequently no deputy will vote for it." For once, writes our correspondent, we have wireless unanimity!

Spain's "Empire Station."

EAQ is the call-sign of one of the most active short-wave broadcasting stations of to-day. It is the Spanish station at Aranjuez, near Madrid, which was recently opened to spread Spanish ideas and culture among the South American countries.

The Marconi 20 kW. transmitter works on wavelengths of 15-20 and 30-35 metres, according to the time of day, and is arranged so that aerials can be rapidly orientated to suit particular needs. Occasional programmes are transmitted over Europe.

Morse Exercises for the R.N.W.A.R.

MEMBERS of the newly formed Royal Naval Wireless Auxiliary Reserve are being given an opportunity to familiarise themselves with Naval Morse signs and procedure by means of special tests by the Whitehall W/T station (Cleethorpes transmitter GYB), which will broadcast a Naval Standard Exercise on Mondays, Wednesdays, and Fridays at 22.30 (B.S.T.) on a wave of 90.2 kcs. The exercise will be transmitted at twenty words per minute, and immediately after its conclusion will be repeated at twelve words per minute to assist checking. The station uses the following call when broadcasting Morse exercises: VE LB9 LB9 V GYB.

It is expected that the R.N.W.A.R. regulations and form of enrolment will be ready for issue within the next day or two, and a meeting of enrolled members of the London district will probably be held on Wednesday, October 12th.

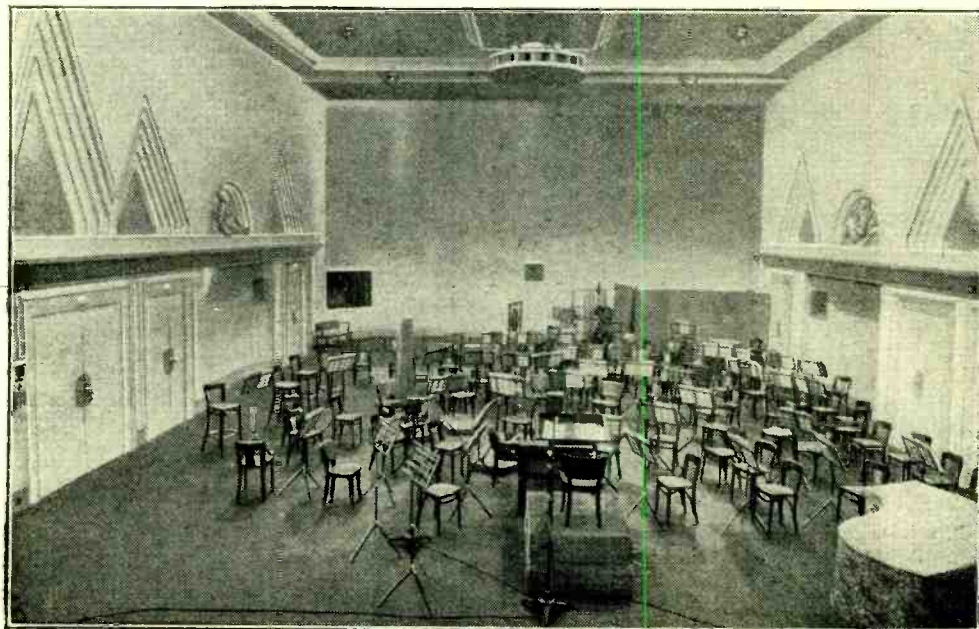

"RADIO ROMA."—The Concert Studio in the new Italian "Radio House." This studio is the largest in Italy.

MANCHESTER RADIO SHOW.

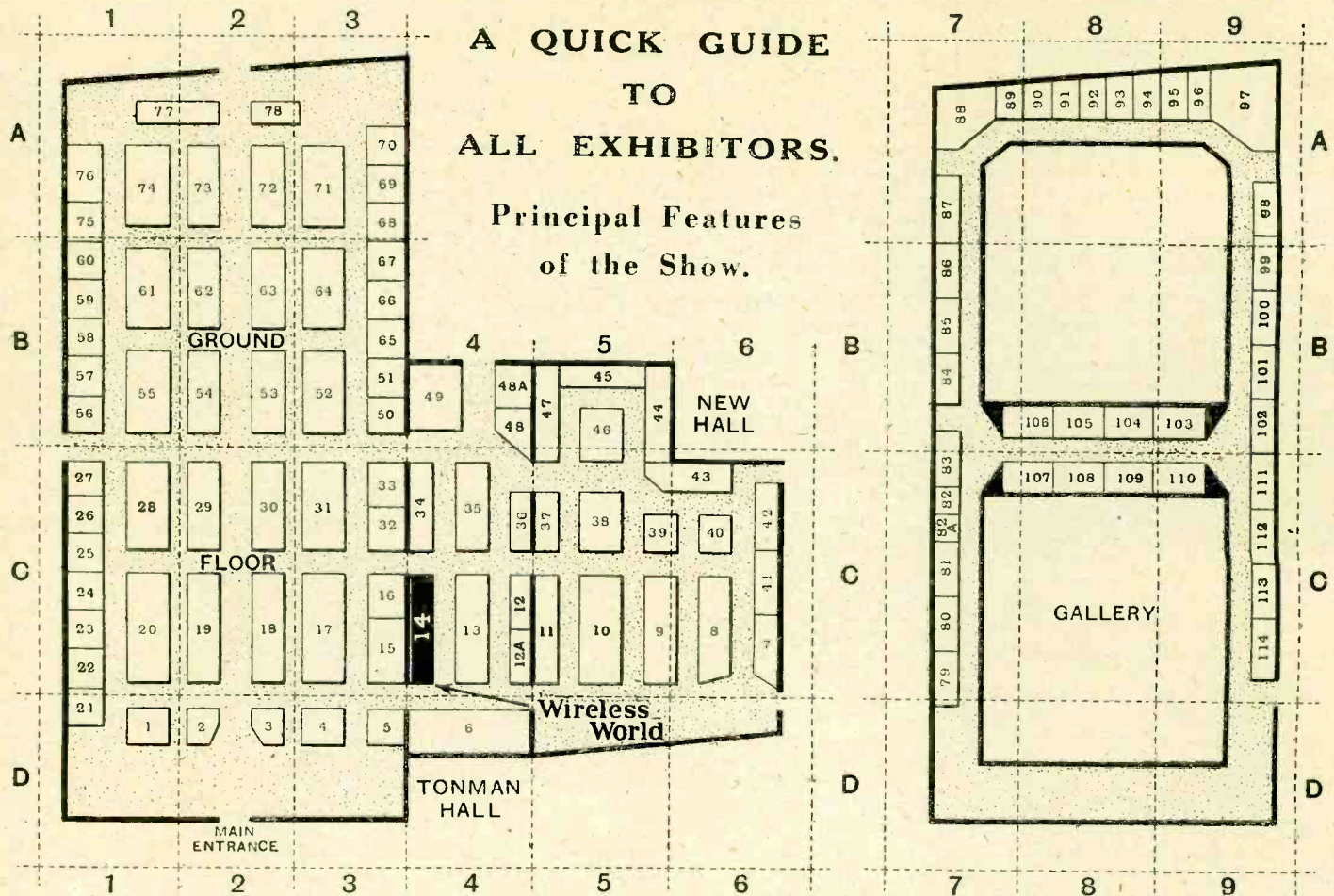

Used in conjunction with the full list of Exhibitors below, the Plan will reveal the whereabouts of any Stand at the Show. The heavy-face reference letter and number in the list refer to the squares on the Plan.

- ALLIED Newspapers, Ltd. (21) D 1
- Withy Grove, Manchester. (22) C 1
- BAKER'S Selhurst Radio 5 D 3
- 89, Selhurst Rd., South Norwood, London, S.E.25.
- Balcombe, Ltd., A. J. 44 B 5
- 52-58, Tabernacle St., London, E.C.2.
- Belling & Lee, Ltd. 27 C 1
- Cambridge Arterial Rd., Enfield, Middlesex.
- Bernard Jones Publications, Ltd. 34 C 4
- 58-61, Fetter Lane, London, E.C.4.
- Britannia Batteries, Ltd. 2 D-2
- 233, Shaftesbury Ave., London, W.C.2.
- British Blue Spot Co., Ltd. 62 B 2
- 94-6, Rosoman St., Rosebery Ave., London, E.C.1.
- British Broadcasting Corporation, Ltd. (94) A 8
- Broadcasting House, London, W.1. (95) A 9
- (96) A 9
- (97) A 9
- British General Manufacturing Co. 12A C 4
- Brockley Works, London, S.E.4.
- British Pix Co., Ltd. (85) B 7
- 42-43, St. Paul's Churchyard, London, E.C.4. (86) B 7
- British Radiophone, Ltd. 69 A 3
- Aldwych House, Aldwych, London, W.C.2.
- British Thomson-Houston Co., Ltd. 48 B 4
- Rugby.
- Brown Bros., Ltd. 42 C 6
- 26, Great Eastern St., London, E.C.2.

THE Ninth Northern National Radio Exhibition was opened at the City Hall, Deansgate, Manchester, on Wednesday last, September 28th, by the Rt. Hon. J. H. Whitley, Chairman of the Governors of the B.B.C. From its earliest days the Show at Manchester has proved a magnet for all radio enthusiasts in the northern part of the country, and it is fitting that special railway facilities are offered this year, enabling visitors from distances up to 60 miles to travel at reduced fares. The Exhibition, which is open daily from 11 a.m. to 10 p.m., is virtually the "Radiolympia" of the north; the majority of the firms represented at the London event have transferred their exhibits to Manchester, where their efforts are augmented by local displays of special interest to the Northern visitor. The demand for space has exceeded that in any previous year, and the Radio Manufacturers' Association, acting in conjunction with Provincial Exhibitions, Limited, have thus been enabled to organise an exhibition which justly deserves the description "bigger and better than ever."

A special mention is due to the *Manchester Evening Chronicle*, which inaugurated this series of radio shows, and, in connection with this year's event, has arranged a number of competitions appealing to home constructors.

- Brownie Wireless Co. of Gt. Britain, Ltd. 16 C 3
- Nelson St. Works, Mornington Cres., London, N.W.1.
- CELESTION, Ltd. 1 D 1
- London Rd., Kingston-on-Thames.
- Chloride Electrical Storage Co., Ltd. 61 B 1
- Exide Works, Clifton Junction, Nr. Manchester.
- Cifel Products, Ltd. 103 B 9
- 134, Pentonville Rd., London, N.1.
- City Accumulator Co. 98 A 9
- 7, Angel Court, Strand, London, W.C.2.
- Clarke & Co. (M/c), Ltd., H. 54 B 2
- George St., Patricroft, Manchester.
- Climax Radio Electric, Ltd. 29 C 2
- Haverstock Works, Parkhill Rd., Hampstead, London, N.W.3.
- Cole, Ltd., E. K. 17 C 3
- Ekco Works, Southend-on-Sea.
- Colvern, Ltd. 76 A 1
- Mawneys Rd., Romford, Essex.
- Consolidated Radio Co., Ltd. 46 B 5
- 75, Kilburn Lane, London, W.10.
- Cossor, Ltd., A. C. 19 C 2
- Cossor House, Highbury Grove, London, N.5.
- DIGGLE & Co., A. 82 C 7
- Excelsior Works, Jane St., Rochdale, Lancs.
- Dubilier Condenser Co. (1925), Ltd. 53 B 2
- Ducon Works, Victoria Rd., North Acton, London, W.3.
- ECONASIGN Co., Ltd. 81 C 7
- 137, Victoria St., London, S.W.1.

Manchester Radio Show.—

Edison Swan Electric Co., Ltd. ... 28 C 1
123, Queen Victoria St., London, E.C.4.

Electrical & Radio Products, Ltd. ... 43 C 6
90, Regent St., London, W.1.

Electro-Dynamic Construction Co., Ltd. 104 B 8
Devonshire Grove, London, S.E.15.

English Steel Corporation, Ltd. ... 112 C 9
Vickers Works, Sheffield.

Ensign, Ltd. ... 7 C 6
88-89, High Holborn, London, W.C.1.

Epoch Radio Mfg. Co., Ltd. ... 102 B 9
Exmouth House, Exmouth St., London, E.C.1. ... 111 C 9

FERRANTI, Ltd.... 74 A 1
Hollinwood, Lanes.

Fuller Accumulator Co. (1926), Ltd. ... 3 D 2
Woodland Works, Grove Rd., Chadwell Heath, Essex.

GARRARD Engineering & Mfg. Co., Ltd. 105 B 8
17, Grafton St., New Bond St., London, W.1. ... 106 B 8

General Electric Co., Ltd. ... 23 C 1
Magnet House, Victoria Bridge, Manchester ... 24 C 1
... 25 C 1
... 26 C 1

Gramo-Radio, Ltd. ... 79 C 7
Commercial Works, Church, Nr. Accrington.

Gresley Radio ... 12 C 4
Ordsall Lane, Salford, Lanes.

HALLIWELL, Ltd., J. R. ... 92 A 8
357, Deansgate, Manchester. ... 93 A 8

Hardman & Co., Ltd. ... 10 C 5
The Baum, Rochdale, Lanes.

Harlie, Ltd. ... 83 C 7
Cambridge Arterial Rd., Enfield.

Hathaway & Co., Ltd., S. ... 100 B 9
King's House, King St. West, Manchester.

Heayberd & Co., F. C. ... 40 C 6
10, Finsbury St., London, E.C.2.

Hellesens, Ltd. ... 70 A 3
Hellesen Works, Morden Rd., S. Wimbledon, London, S.W.19.

Hobday Brothers, Ltd. ... 6 D 4
21-27, Gt. Eastern St., London, E.C.2.

Hollingdrake & Son, Ltd., H. ... 114 C 9
65, Prince's St., Stockport.

Hustler, Simpson, & Webb, Ltd. ... 107 C 8
317, Hoe St., Walthamstow, London, E.17.

IGRANIC Electric Co., Ltd. ... 72 A 2
147, Queen Victoria St., London, E.C.4.

Iliffe & Sons, Ltd. ... 14 C 4
Dorset House, Tudor St., London, E.C.4.

Itonia, Ltd. ... 41 C 6
58, City Rd., London, E.C.1.

JUNIT Mfg. Co., Ltd. ... 78 A 2
Junit Works, Steele Rd., Chiswick, London, W.4.

KOLSTER-Brandes, Ltd. ... 31 C 3
Cray Works, Sidcup, Kent.

LISSEN, Ltd. ... 50 B 3
Isleworth, Middlesex. ... 51 B 3
... 65 B 3
... 66 B 3
... 80 C 7

Loewe Radio Co., Ltd. ... 80 C 7
Fountainy Rd., Tottenham, London, N.15.

Lotus Radio, Ltd. ... 30 C 2
Lotus Works, Mill Lane, Old Swan, Liverpool.

MCMICHAEL, Ltd., L. ... 71 A 3
Wexham Rd., Slough.

Marconiphone Co., Ltd. ... 55 B 1
210-212, Tottenham Court Rd., London, W.1.

Mullard Wireless Service Co., Ltd. ... 20 C 1
Mullard House, Charing Cross Rd., London, W.C.2.

Murphy Radio, Ltd. ... 9 C 5
Broadwater Rd., Welwyn Garden City, Herts.

NATIONAL Accumulator Co., Ltd. ... 38 C 5
50, Grosvenor Gardens, London, S.W.1.

New London Electron Works, Ltd. ... 4 D 3
East Ham, London, E.6.

Northern Steel & Hardware Co., Ltd. ... 87 A 7
1-3, Southgate, Deansgate, Manchester. ... 88 A 7

ODHAMS Press, Ltd. ... 84 B 7
68, Long Acre, London, W.C.2.

Oldham & Son, Ltd. ... 52 B 3
Denton, Nr. Manchester.

Ormond Engineering Co., Ltd. ... 77 A 1
Ormond House, Rosebery Ave., London, E.C.1.

Osborn, Chas., A. ... 45 B 5
Regent Works, Arlington St., London, N.1.

PARTRIDGE, Wilson & Co. ... 75 A 1
Davenet Works, Evington Valley Rd., Leicester.

Pegasus, Ltd. ... 91 A 8
Low Mills, Lower Wortley, Leeds.

Philips Lamps, Ltd. ... 64 B 3
145, Charing Cross Rd., London, W.C.2.

Portadyne Radio, Ltd. ... 36 C 4
Gorst Rd., N. Acton, London, N.W.10.

Pye Radio, Ltd. ... 18 C 2
Paris House, Oxford Circus, London, W.1.

RADIO Instruments, Ltd. ... 110 C 9
Purley Way, Croydon.

Ready Radio, Ltd. ... 35 C 4
Eastnor House, Blackheath, London, S.E.3.

Regentone, Ltd. ... 63 B 2
21, Bartlett's Bldgs., Holborn Circus, London, E.C.4.

Richardsons (R.M.L.), Ltd. ... 49 B 4
24, St. John St., Deansgate, Manchester.

Ridings Reliance, Ltd. ... 11 C 5
338, Stockport Rd., Ardwick, Manchester.

Roberts, John ... 101 B 9
1-3, Bridgewater Viaduct, Knott Mill, Manchester.

SIEMENS Electric Lamps & Supplies, Ltd. ... 15 C 3
38-39, Upper Thames St., London, E.C.4.

Small Power Dynamo & Motor Co., Ltd. 99 B 9
Old Lane, Higher Openshaw, Manchester.

Sovereign Products, Ltd. ... 60 B 1
52-54, Rosebery Ave, Clerkenwell, London, E.C.1.

Steinbac, Ltd. ... 90 A 8
303, Essex Rd., London, N.1.

TELSEN Electric Co., Ltd. ... 13 C 4
Aston, Birmingham.

Thompson, Diamond & Butcher, ... 47 B 5
34, Farringdon Rd., London, E.C.1.

Trade Chronicles, Ltd. ... 113 C 9
6, Carmelite St., London, E.C.4.

Trader Publishing Co., Ltd. ... 37 C 5
St. Bride's House, Salisbury Sq., Fleet St., London, E.C.4.

Trojan (Manchester), Ltd. ... 8 C 6
8-12, Alexandra Rd., Moss Side, Manchester.

ULTRA Electric, Ltd. ... 56 B 1
Erskine Rd., Chalk Farm, London, N.W.3. ... 57 B 1
... 58 B 1
... 59 B 1
... 48A B 4

United Radio Manufacturers, Ltd., ... 63, Lincoln's Inn Fields, London, W.C.2.

Universal Electric Supply Co., Ltd., ... 108 C 8
4, Brown St., Manchester. ... 109 C 8

VARLEY (Oliver Pell Control, Ltd.), ... 67 B 3
103, Kingsway, London, W.C.2. ... 68 A 3

WELLWORTH Wireless Co., ... 82A C 7
8, Withy Grove, Manchester.

Westinghouse Brake & Saxby Signal Co., Ltd. ... 73 A 2
82, York Rd., London, N.1.

Whiteley Electrical Radio Co., Ltd. ... 32 C 3
Nottingham Rd., Mansfield, Notts. ... 33 C 3

Wingrove & Rogers, Ltd., ... 39 C 5
Mill Lane, Old Swan, Liverpool

Wireless Retailers' Association of Gt. Britain & Northern Ireland ... 89 A 7
1, Mitre Court, London, E.C.4.

"Wireless World" ... 14 C 4
Dorset House, Tudor St., London, E.C.4.

Guide to the Exhibits.

THE NEW SETS.

BEFORE describing the new receivers to be seen at Manchester it will save much needless repetition if we remind readers that the typical set for 1932-33 is self-contained with its loud speaker, that no externals beyond an aerial and earth connection are needed, and that

single-knob tuning is fitted. Batteries are almost invariably contained in the cabinet nowadays, but, of course, mains sets require an extra connection to the source of supply. It may be assumed that the receivers to be discussed will almost invariably include all these features.

There is little scope for originality in the design of two-valve sets, but merely because they are not particularly interesting from the technical point of view we must not dismiss them as being unimportant. On the contrary, this circuit arrangement is as widely used as ever in sets designed to satisfy the needs of those who must study economy, or who do not require a wide choice of programmes.

A two-valve receiver which is much more ambitious than the average specimen is the Pye Model K, with an inductively coupled input filter and a large power output. Generous volume has been wisely made a feature of many of these sets; the Corsor and Pegasus products are good examples of this tendency. The appropriately named Lotus "Bud" A.C. set is priced at 10 guineas, a fair average price nowadays for an "all"-mains set of this type.

The local firm of Clark's Atlas has recently entered the set market with a series of two-valve receivers for A.C., D.C., and battery



An inexpensive Lissen set for battery feed.

Manchester Radio Show.—

feed. All are fitted with moving-coil loud speakers, that for the battery model being, of course, of the permanent-magnet type.

Inexpensive self-contained two-valve battery sets are now produced by a number of firms. Columbia and Marconiphone have models at under £5, while the Brownie set is sold complete at the extremely low figure of £3. Lissen and Kolster Brandes also have low-priced receivers, the product of the latter firm costing £3 15s. One of the few sets without a built-in loud speaker is the neat little Regentone mains set in a compact moulded bakelite cabinet.

Three-valve H.F.-det.-L.F. combinations account for roughly 40 per cent. of the new season's productions of the British wireless industry. This is clearly the most popular type of receiver, and it would be quite impossible to describe here all the examples that are shown. Band-pass tuning is included in most of the more ambitious sets,

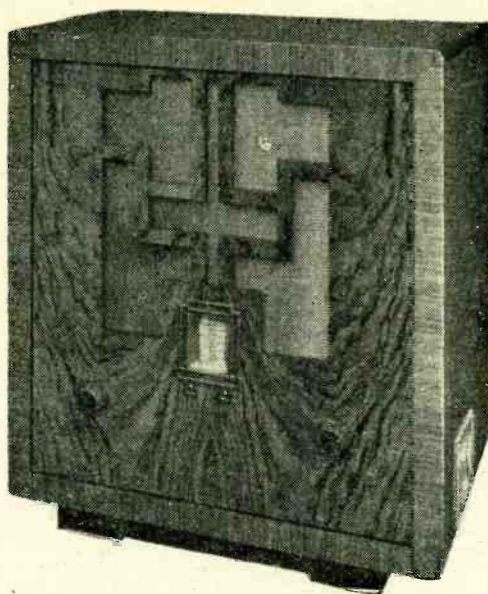

The K.B. model 320; an inexpensive "two-H.F." set.

pedestal stand for this compact radio-gramophone has been introduced since Olympia. Other sets to which attention should be drawn are the M.R.G. instruments, both upright and table models, and the Ultra, which is representative of modern practice and has a novel indicator scale. The Alba (A. J. Balcombe) concern have introduced new models since the London show, including a mains-operated radio gramophone at 22 guineas.

Kolster Brandes naturally have a three-valve model, and also a very interesting example of the simpler type of two-H.F.-det.-L.F. set which seems to be becoming a competitor of the standard three-valve circuit.

Unconventional tuning systems are rather rare, but the British General receiver, with its four tuned circuits (band-pass input and band-pass interval coupling) is an exception, and should have outstanding selectivity for its class.

As already implied, the sets dealt with so far need an external aerial of sorts, although almost all the "H.F." models will provide medium-range reception with the most inefficient of collectors. Those who must

use frame aerials are not very widely catered for, except by portable set makers, but the new McMichael Transportable Four, designed for mains operation and with two-H.F. stages, is an example of a truly self-contained set; with its frame it should have at least the range of a good standard three-valve set working with a normal aerial.

With singular unanimity the wireless industry has decided that listeners without mains supply are worthy of more attention; as a result, very many interesting battery sets have been introduced and most of them are in the present three-valve category. For example, Marconiphone has a band-pass 1-v-1 set with a high-efficiency pentode and such refinements as a local-distance switch. Similarly, the up-to-date Lotus receiver, with a moving-coil loud speaker, also has many of the refinements which are usually associated only with mains-driven sets. The Gresley Radio Band-Pass Three,

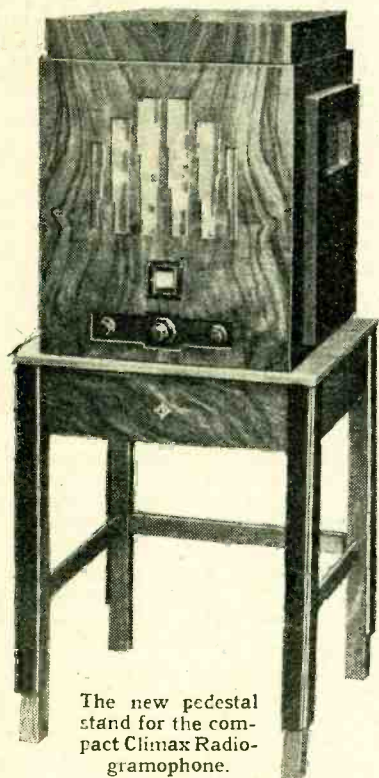

The new pedestal stand for the compact Climax Radio-gramophone.

including the new Marconiphone A.C. model, of which the performance is stated to have been greatly improved by almost complete redesign of the circuits.

Similarly, the Murphy A.C.3 has been partly redesigned, and is now supplied with a pedestal stand. There is also a new Pye set with a special L.F. amplifier designed to afford immunity from heterodyne whistles.

The present tendency to use a screen grid valve as a detector and thus to attain better sensitivity and notably better "ganging" is exemplified in the G.E.C. sets, all of which are so fitted. Incidentally, they also include whistle filters. The "Gala" is the G.E.C. model in our present category.

Although of simple design, the Ekco three-valve set is known to be extraordinarily selective and is sensitive as well; indeed, it is hard to find a technically acceptable explanation of its outstanding performance.

Some of the models already mentioned are available in radio-gramophone form; three-valve circuits are quite popular for this purpose, and an example may be found in the Climax table model. Incidentally, a

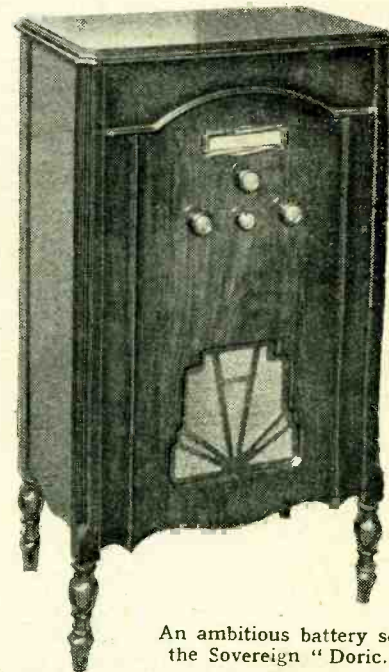

An ambitious battery set: the Sovereign "Doric."

a locally produced battery set, embodies an input filter, a moving-coil loud speaker, and automatic grid bias.

The Sovereign firm has a complete range of up-to-date battery sets, and the new Pegasus programme also caters for battery users; their three-valve receiver has band-pass tuning, a balanced armature loud speaker, and is fitted with Siemens double-capacity batteries. Blue Spot are showing battery sets with both inductor and permanent magnet moving-coil loud speakers. An inductively coupled band-pass filter, which, incidentally, is now included in quite a number of sets, is a feature of the Columbia H.F.-det.-L.F. battery outfit.

Interest in the short-waves continues to grow, and provision for reception on this band is provided in a number of sets which are primarily designed to operate on the normal broadcast wavelengths. A notable example of this tendency is to be seen in the Kolster Brandes sets, both of the straight and superheterodyne types. Short-wave adaptors also seem to be popular; among those shown is the R.I. Anti-Nodal, which is designed for connection to the detector valve socket of an existing receiver. Since Olympia a new A.C. model of this converter has been introduced. In order that its application may be practically universal, this instrument is complete with its own

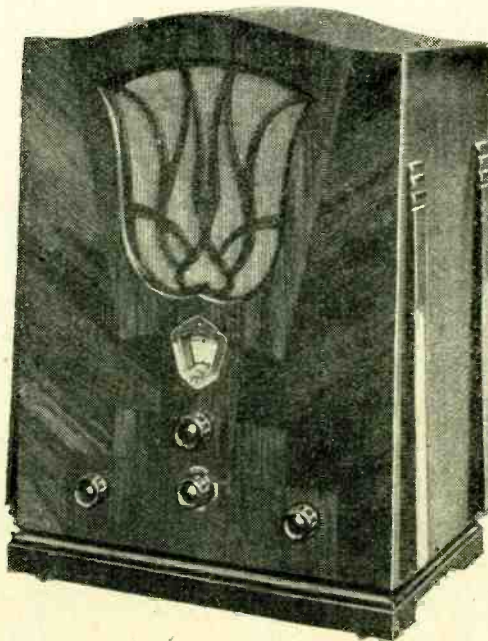

Lotus four-valve de luxe receiver.

Manchester Radio Show.—

power supply system. While dealing with specialised apparatus we must not forget the Pye "Schools" receiver, of which the moving-coil loud speaker forms a separate unit.

Superheterodynes

Probably the majority of the multi-valve receivers on view are of the superheterodyne type. This is not to say that they are in any way alike, however, for the classification of superheterodyne covers a wide diversity of types, and the number of valves employed may range from as low as five to as many as nine or more.

On this basis, the Ferranti superheterodyne, which was recently reviewed in *The Wireless World*, falls into the middle class, since a total of seven valves is fitted. Variable- μ types are used for the preliminary H.F., the first detector, and the single I.F. amplifier, and a grid second detector feeds a triode output valve rated to deliver some 1,000 milliwatts to the built-in moving-coil loud speaker. Ganged tuning is employed as a matter of course, and the band-pass principle is adhered to in the I.F. circuits. The dimensions are exceptionally small, and the complete receiver sells for 22 guineas.

A complete range of the Philco sets is to be found on the stand of Hardman and Co., and a five-valve superheterodyne, the model 56, is shown at the price of 16 guineas. Both medium and long wavebands are covered and a band-pass filter precedes the combined first detector and oscillator, for which a screen-grid valve is used. A single variable- μ valve in conjunction with four tuned circuits forms the I.F. amplifier, and the screen-grid anode-bend second detector is resistance coupled to the output pentode. The fifth valve is the H.T. rectifier. Similar receivers for D.C. mains and batteries are available at the same cost, while more ambitious types are to be found at prices up to 65 guineas for a seven-valve radio-gramophone.

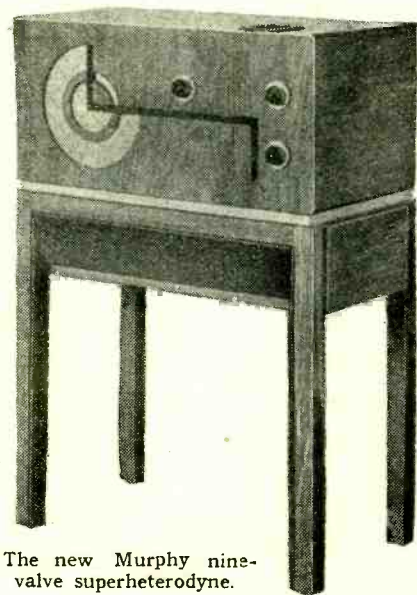

The new Murphy nine-valve superheterodyne.

The Murphy Radio nine-valve receiver is an example of the larger class of superheterodyne, and should not be overlooked if only on account of the interesting departures from normal practice. Variable- μ valves are used for the H.F., first detector, the two I.F., and the first L.F. stages; the output valve is a pentode, and the only triode is that used for the oscillator. The second

detector is a duo-diode, a full-wave diode rectifier, and it allows of the attainment of linear detection with automatic volume control. The three signal-frequency circuits include a band-pass filter, but, in order to minimise background hiss, this is connected between the H.F. and first detector valves instead of between the aerial and the first valve.

The Ekco five-valve set will repay inspection, for it incorporates unusual features in the way of special elimination circuits for I.F. and second channel interference. It is, of course, completely mains operated. Electrical and Radio Products have a seven-valve set, the Mayfair, in which a preliminary stage of H.F. amplification is employed, while the Pye S model is of the six-valve type and sells for 27 guineas. The Varley superheterodyne is of the five-valve type, and a band-pass filter is used to precede the frequency changer. A single I.F. stage is fitted.

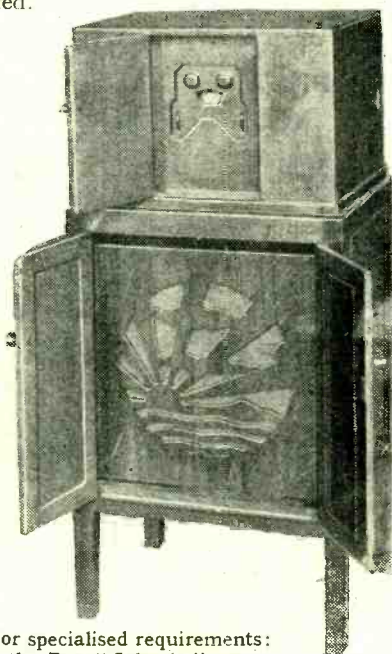

For specialised requirements: the Pye "Schools" set.

In view of the large number of valves normally employed, the superheterodyne is primarily a mains-driven receiver. Nevertheless, creditable efforts have been made to reduce the current consumption, and a number of battery driven models is available which should prove quite economical in use. The Marconiphone portable is one of these; six valves are used, and the total anode current consumption is claimed to be 10 mA. Automatic grid bias through the voltage drop along a resistance in the H.T. circuit is included, and at the price of 17 guineas it is distinctly interesting. A seven-valve mains-driven set is being shown by the same firm, and in this a variable- μ H.F. valve precedes the screen-grid first detector to which the triode oscillator is coupled. The single I.F. stage employs another variable- μ valve, and the triode output is of the P.X.4 type.

Although the G.E.C. is showing a superheterodyne, most of its models are of the straight H.F. type, and it is interesting to note that the screen-grid valve is now finding wide application as a detector, the advantage to be gained from its use being not so much increased efficiency as the absence of anti-phase feed-back through inter-electrode valve capacities. The Viking model has two H.F. stages with a total of four tuned circuits, and the pentode output valve delivers some 2½ watts to the loud speaker. The price is 23 guineas.

The well-known Dynatron sets are being shown on the stands of J. R. Halliwell, and an example of sound design is to be found

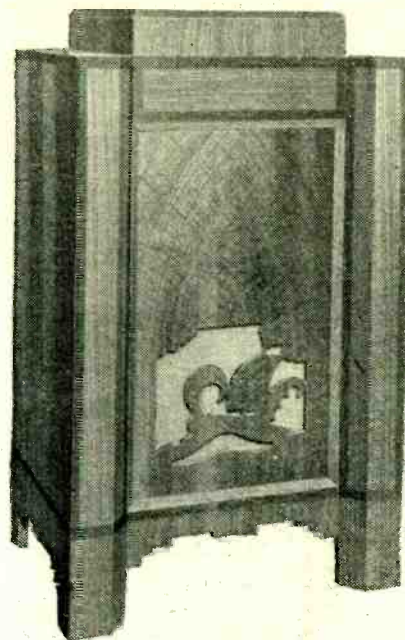

A modern note in cabinet design: the Varley superheterodyne radio-gramophone.

in the Ether King. Two variable- μ H.F. stages are employed with four tuned circuits, and are followed by a power grid detector. Two push-pull P.P.5/400 valves are used in the output stage, and, in conjunction with the dual loud speakers, enable exceptionally large volume to be obtained.

The Philips Super Inductance Four receivers are on view, and very high efficiency is claimed for the coils employed, while a high degree of mechanical accuracy in the condensers is necessitated by the unusually close spacing of their plates. Two screen-grid H.F. stages are fitted, with four tuned circuits arranged as two band-pass filters, the second H.F. and detector valves being coupled through an aperiodic circuit having characteristics designed to compensate for the natural deficiencies of the tuned couplings.

The low-frequency arrangements of the A.C. model are fairly conventional, but not so those of the battery set. In the latter, a grid detector is connected across the loud speaker, and its anode circuit is interconnected with the bias system of the pentode output valve in such a way that the pentode bias is always as negative as pos-

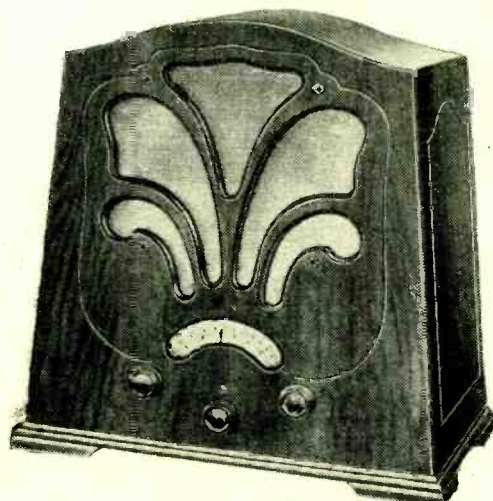

Marconiphone self-contained H.F.-det.-L.F. mains set.

Manchester Radio Show.—

sible without distortion being introduced. The anode current is thus always at a minimum, and fluctuates according to the volume from the loud speaker.

British Blue Spot are showing a battery set of the "two-H.F." three-circuit class in which variable- μ valves are used for the H.F. stages. A permanent-magnet moving-coil speaker is fitted, and the total anode current consumption is 12½ mA. It is priced at 16 guineas. Brownie Wireless, on the other hand, in its four-valve battery set has adhered to the single H.F. amplifier, and the instrument consequently includes two L.F. stages.

Pegasus has an interesting four-valve A.C. set. There are two variable- μ H.F. stages with four tuned circuits, detector, and a 2½ watts pentode output stage. Three wave-ranges are included, for, in addition to the usual 200/550 metres and 800/2,000 metres ranges, provision is made for reception over the band of 15/50 metres. The price is 24 guineas.

Kit Sets.

Kit set constructors should find plenty to interest them; the Ferranti programme alone provides for almost every requirement. The cheapest outfit (at 40s.) comprises a set of parts for a 1-v-1 set with an aperiodic H.F. stage, detector and transformer-coupled output valve; regeneration is controlled by a resistance in the screen-grid circuit. Skipping intermediate Ferranti models, in the design of which both battery and mains users are catered for, there are two very ambitious four-stage sets with band-pass tuning and power outputs of about 6 and 12 watts.

The W.B. kit of parts for a three-valve det.-2-L.F. set, which aroused a good deal of interest at Olympia, is now more prominently displayed. This consists of several

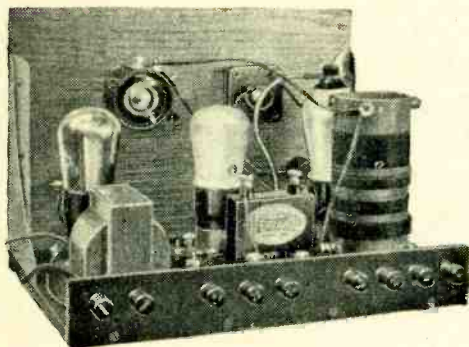

Ferranti kit set with aperiodic H.F. stage.

units rather than a number of parts, and only a few connections have to be made; the set is of the cabinet type, and includes a moving-coil loud speaker. Another very ingeniously devised kit, comprising only four units, is shown by Ready Radio.

As it has been on the market for some time, the latest G.E.C. Music Magnet hardly need be described; briefly, it is of the 1-v-1 type, and is entirely self-contained with the loud speaker and batteries. It is one of the most ambitious kits of its type, and embodies most unconventional features both in its circuit and construction.

Almost every circuit combination is to be found in the Telsen kits, and in addition many useful gadgets and sets of accessories are also provided by this firm in kit form.

The well-known Cossor Melody Makers have also been redesigned and are now available in various styles, self-contained and

otherwise; they are now fitted with variable- μ H.F. valves. In the C.A.C. radiogramophone kit the L.F. stages are linked by the special C.A.C. coupler, which comprises an arrangement of wire-wound resistance coils.

The detector-2 L.F. circuit is very popular for kits, and is included in the Lotus three-valve set, but in the Lissen Sky-scraper, sold at 89s. 6d., the same number of valves are used in an H.F.-det.-L.F. combination arranged on conventional lines.

Components.

There are many new components being exhibited which will materially simplify the home constructor's task of building a modern receiver. The vogue of one-dial control of a multiplicity of tuned circuits makes it imperative that each coil and its tuning condenser shall tune to resonance simultaneously. This can be more easily achieved if the coils and ganged condensers are sold as a composite unit in which care has been taken to match the inductances and capacities and to make the wiring and

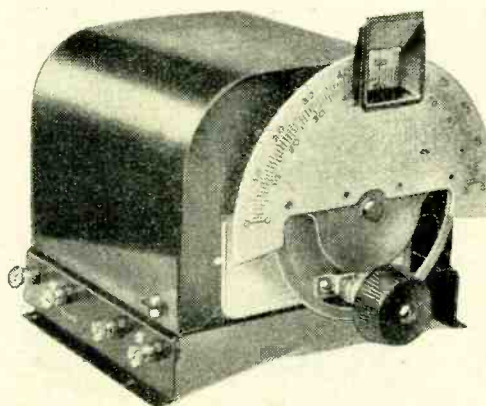

Ferranti triple-gang condenser.

layout symmetrical. The British Radiophone "Radiopak" is an excellent example of this new development. For the straight set there is a three-membered unit with single-circuit input and a band-pass interval coupling so designed that amplification is practically uniform over the waveband. The coupling between the band-pass members is held constant by the use of a mixed capacity and inductive circuit. Another condenser-coil unit is being shown by Colvern; here the band-pass unit precedes the first valve.

There is now a wide choice of ganged condensers which can be relied upon for accurate matching of capacity. The Ferranti triple-gang unit is an example of fine

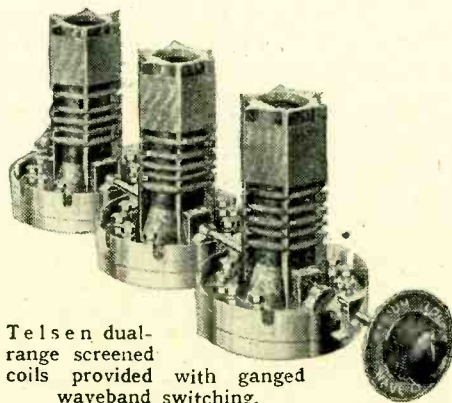

Telsen dual-range screened coils provided with ganged waveband switching.

workmanship, in which the screening is particularly well carried out. Other examples are the Polar "Star" (Wingrove and

Rogers) and Lotus ganged condensers, the range including "shaped" vanes for the oscillator circuit in single-control superheterodynes.

Screened dual-range coils with provision for ganged waveband switching are to be found on a large number of stands, among

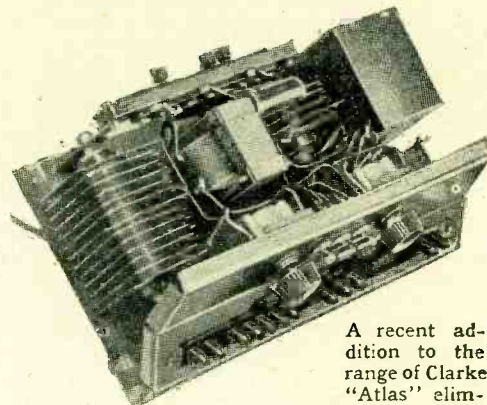

A recent addition to the range of Clarke "Atlas" eliminators.

which may be mentioned Telsen and Colvern, the product of the latter firm being arranged with coupling condensers and leaks in the base. Considerable attention has been given to the design of screened oscillator coils and band-pass intermediate coils suitable for 110 kc. I.F.

Mains equipment is well represented this year. Partridge and Wilson are exhibiting a new range of transformers and power smoothing chokes styled Class "A." These are of particularly liberal rating with low copper losses and good regulation. There are also available mains transformers for all the latest additions to the Westinghouse series of metal rectifiers. This firm is showing a useful range of "Grippleshell" aerial brackets, which, to quote one of their many uses, hold the downlead away from a building and prevent it from swaying in the wind.

Messrs. H. Clarke and Co. (M/C), Ltd., have a very ambitious programme for the new season. Their well-known eliminators are retained with only slight modifications.

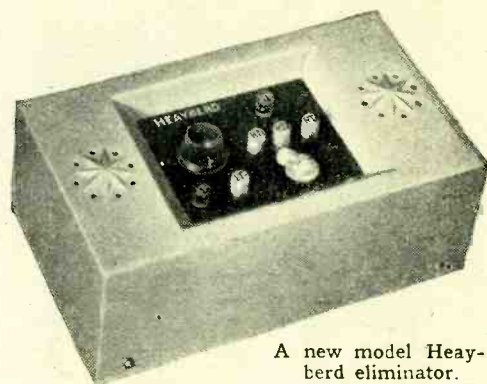

A new model Heyberd eliminator.

The larger models comprise a circuit which ensures extremely good regulation when the load is changed within wide limits. A similar arrangement, comprising a tapped "line" resistance, is used on the Regentone models. Heyberd have a large number of eliminators both for D.C. and A.C. mains, and Ferranti, who can fairly claim to be pioneers in the mains unit field, have added a number of new models this year. The E4, with an output of 70 mA. at 240 volts, is an eliminator of wide appeal. There are two L.T. windings, one for 4 volts 5 amps., and the other for 4 volts 1 amp., so that a directly heated output valve can be used. A typical superheterodyne for which this unit is suitable might employ a separate oscillator, two variable-

Manchester Radio Show.—

mu valves to act as first detector and I.F. valves, a triode second detector, and an output valve of the PX4 type. On Gresley's stand are to be found a comprehensive range of eliminators selling at popular prices.

There are a number of new Westinghouse metal rectifiers, including a series having a high-voltage output. The H.T.11, for instance, is capable of delivering 120 mA. at 500 volts, while the H.T.10 is rated at 100 mA. and 200 volts. A metal rectifier which should meet popular demand is the HT9, giving 60 mA. at 300 volts, allowing an ample H.T. of 200 volts after 100 volts have been lost in the speaker field.

The almost universal employment of variable-mu valves in H.F. amplifiers has led to the demand for bias potentiometers having a value of 5,000 to 10,000 ohms, capable of handling fairly heavy currents.

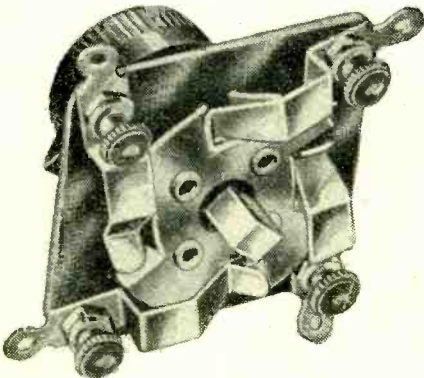

Lotus multi-contact switch.

A number of these components are being shown, notably on the stands of British Radiophone, Colvern, and Varley. Provision is also being made for ganging two potentiometers with an on-off switch.

Tone control units are a new development and make their appearance on Varley's stand. On the Ediswan stand a thermal delay switch mounted in vacuo is being shown, having the advantage of being unaffected by atmospheric conditions; furthermore, arcing of the contacts cannot occur.

Battery-charging plants will be found on the stands of The Small Power Dynamo and Motor Co., Ltd., and John Roberts, the regulation scheme employed in certain equipments of the last-named company

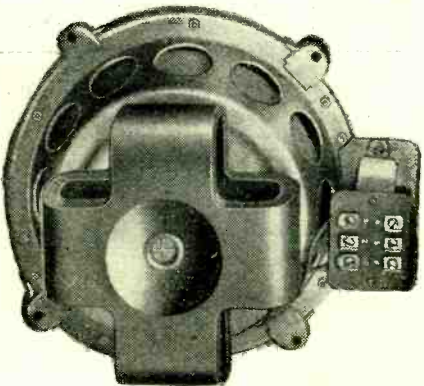

Marconiphone model 93 permanent-magnet moving-coil loud speaker chassis.

being so designed that whilst charging 60 volts on one line it is possible to charge a single 2-volt cell on any other line.

Valves.

New valves of importance are the Mazda DC/2SGVM (Edison and Swan) and the Marconi and Osram VDS, both of which

are indirectly heated variable-mu valves for D.C. mains. In the 2-volt battery class a wide choice of variable-mu valves is now available; there is the Cossor 220VSG, the Mazda S215.VM, the Marconi and Osram VS2, and the Mullard PM12V, all of which are capable of giving a full-range control of volume, making use of the bias battery for the output stage. Additions have been made to the range of directly heated pentodes. For high-quality reproduction at a realistic level, the following newcomers have been developed: The Marconi and Osram PT25, Cossor PT41B, and the Mullard PM24M.

Loud Speakers.

The best represented type is undoubtedly the permanent-magnet moving coil. Loud speakers in this category range in size and price from the miniature models at about 27s. 6d. represented by the Celestion "Soundex," the Epoch-type MM Junior, and the Whiteley Electrical "Mansfield" PM5, to super-power models such as the Ediswan R.K. Senior, Ferranti M1, Marconiphone Model 93, Celestion PPM29, and the Whiteley PM1.

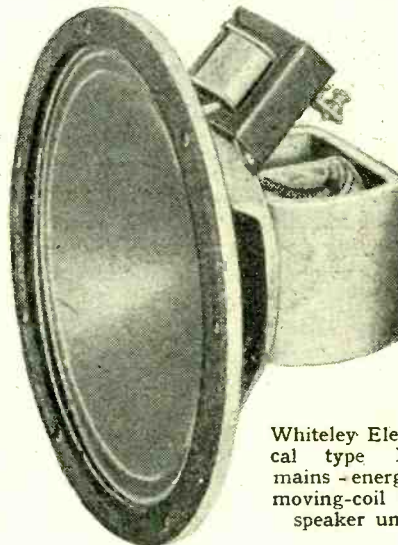

Whiteley Electrical type EM1 mains-energised moving-coil loud speaker unit.

It is probable, however, that the greatest interest will be shown in the intermediate size of permanent-magnet unit represented by such makes as the new Ferranti M2 and M4T units, the Ormond R/475 and R/464 models, the Loewe PML200, the Ediswan R.K. Minor and the W.B. (Whiteley) types PM2 and PM4. The Bakers Selhurst "Permag" cabinet loud speaker is now fitted with a tone control on the front of the cabinet and gives a reduction in the output in the upper register to cope with interference due to atmospherics or electrical disturbance. The full range of the loud speaker is, of course, available when interference is absent. Visitors to the Show should not fail to visit the stand of H. Clarke and Co. (M/C), Ltd., where the recently introduced "Atlas" permanent-magnet moving-coil loud speaker is being displayed; the Blue Spot stand, where the strongly built 99PM chassis is shown in cabinets of very attractive design; and the Epoch stand, where the medium-size permanent-magnet moving coil is represented by the new edition of the well-known type A2 and the new type 20c unit.

Much of the credit for the improvement in the performance of permanent-magnet moving-coil units must be given to the magnet designers, and a comprehensive dis-

play of designs incorporating the latest practice are to be found on the stand of the English Steel Corporation, Ltd.

Mains-energised moving-coil models have recently received more attention under the stimulus of mains receiver design, and notable examples of this type include the



Clarke "Atlas" permanent-magnet moving-coil chassis.

Bakers Selhurst "Elomag," the Celestion D.C.8 and D.C. "Soundex," the Ferranti D3, and the Whiteley Electrical type EM1.

The moving-iron type of unit still has a strong following, particularly among users of battery receivers where a high degree of sensitivity is required. Visitors in search of a unit of this type will find many points of interest in the new Blue Spot 66K model and the type 66R, which is designed for large power inputs. The inductor type of moving-iron unit is represented by the Blue Spot 100U and the Ferranti 1933 inductor chassis, which has been redesigned.

Dual unit loud speakers will be found on many of the receivers exhibited, and a comprehensive range for all types of power output are shown on the Epoch stand.

Gramophone Accessories.

Among accessories associated with the reproduction of gramophone records, one of the most interesting exhibits is the Garrard record changer. This unit is capable of handling eight 10in. or 12in. records, and is of simple and robust design, the whole

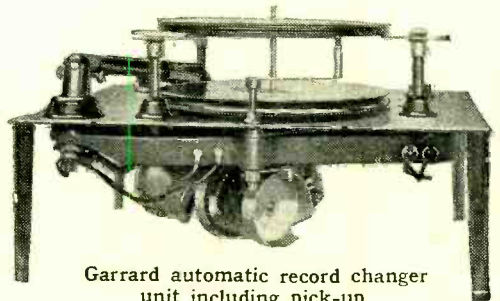

Garrard automatic record changer unit including pick-up.

movement being controlled by a single cam drum. The new B.T.H. turntable motors will also repay examination, particularly the self-starting synchronous "Truspeed" and the slow-speed "Universal" motor. Pick-ups are well represented and are to be found on the British Radiophone, Blue Spot, Celestion, Ediswan, Loewe, and Marconiphone stands.

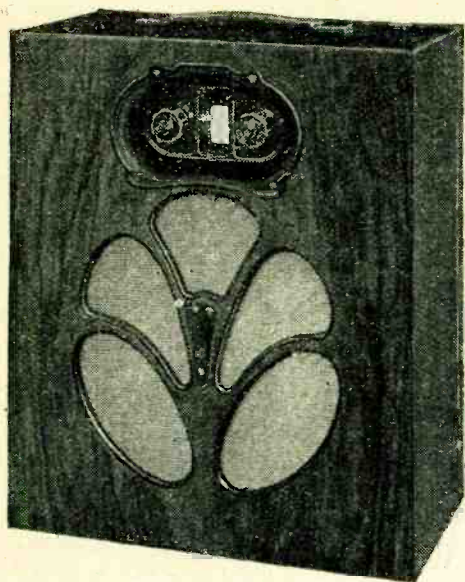

H.M.V. Superhet

MODEL 459.

Portable Six.

A Self-contained Battery Superheterodyne.

A single screen-grid I.F. stage is used and is fed from the first detector through a band-pass filter, although the coupling to the second detector is by means of the tuned anode circuit. There is thus a total of three I.F. tuned circuits. The grid second detector is transformer coupled, by means of an instrument having a 7-1 step-up ratio, to the P.T.2 output pentode, in the anode circuit of which the moving-iron type loud speaker is connected.

The H.T. supply to the various valves is thoroughly de-coupled, and all circuits are well by-passed to the earth line. Automatic grid bias is obtained through the insertion of a resistance between the negative terminals of the L.T. and H.T. batteries, and it will be obvious that as the H.T. battery potential falls and the anode current is reduced the valves have a smaller negative bias voltage applied to them. The result is that distortion and loss of sensitivity when the H.T. battery is running down is reduced.

The mechanical construction reaches a very high standard, and is exceptionally robust. The receiver is assembled on a steel chassis which is held to the cabinet through a rubber suspension in order to avoid the effects of acoustic feed-back. The batteries fit into the lower compartment, and are accessible.

The cabinet itself is solidly constructed of polished walnut, and a stout leather carrying handle is let into the top. The overall dimensions are rather below the average, and it is a noteworthy achievement on the part of the designers that they have managed to compress within such a small compass a six-valve superheterodyne, frame aerials, loud speaker, and batteries. There are four controls arranged in two concentric pairs.

Since the I.F. circuits include only three tuned circuits, it is to be expected that the adjacent channel selectivity would be lower than that of the average superheterodyne, and this is indeed the case. Owing to the directional properties of the frame aerial, however, and the null point is extremely well defined, it proved possible to receive Mühlacker without any serious interference from the London Regional at a distance of only nine miles from the latter. This could only be done, however, when the set is used at a point where the relative directions of the two stations are such that the frame can be set at right angles to the local. The nearest station to London which could be obtained quite free from interference without making use of directional reception was Radio L.L., Paris.

On the long waveband, Königswusterhausen could be obtained without serious interference from either Daventry National or Radio-Paris. It will be seen, therefore, that the adjacent-channel selectivity is exceptionally high for a portable receiver, and it is only low when compared with large superheterodynes. In conjunction with the directional properties of the frame aerial, the effective selectivity becomes nearly equal to that of the larger type of set.

Orientation of Frame.

The sensitivity is adequate for most purposes, and Langenberg can be obtained at reasonable strength in daylight.

Tuning is effectively single control, for the aerial trimmer requires only occasional adjustment; in a run from one end of the waveband to the other, for instance, the trimmer may have to be adjusted two or three times. The volume control operates smoothly, but when receiving a powerful local it may prove necessary to augment its action by the local-distance switch at the back of the cabinet, which reduces the resistance of the second detector grid leak. Over-emphasis of low notes can also be reduced in certain circumstances by setting this switch in the "local" position, while a considerable improvement in the ratio of signal to background noise is obtained with this setting.

The control of the receiver is of the simplest, and it is economical to operate, not only as regards the H.T. supply, but in respect of the L.T. also, for the valve filaments draw some 0.65 ampere at 2 volts. Beyond the occasional replacement of the H.T. battery, and the re-charging of the accumulator, the set should require no attention.

FEATURES.

General.—Six-valve portable superheterodyne with self-contained frame aerials, loud speaker and batteries. Provision for the connection of external loud speaker, gramophone pick-up and aerial and earth.

Circuit.—Screen-grid valves for the H.F., first detector, and I.F. stages, with triode oscillator and grid second detector. Economical pentode output, ganged tuning and automatic grid bias.

Power Supply.—H.T. from dry battery; 10 mA. total current consumption at 120 volts. Unspillable L.T. 2-volt accumulator; current consumption, 0.65 ampere.

Controls.—(1) Main tuning control with calibrated drum dial. (2) Aerial trimming condenser. (3) Volume control. (4) Combined waverange and on-off switch. (5) Local-distance switch.

Price.—17 Guineas.

Makers.—The Gramophone Co. Ltd., 363/367, Oxford Street, W.1.

THE portable receiver has enjoyed a large measure of popularity in the past, but, owing to the simple nature of the circuits which were employed, the selectivity of the older types often proved inadequate to deal with modern conditions. Great difficulty attaches to the use of highly selective tuning arrangements, for considerations of space forbid the employment of many tuned circuits, and limit the efficiency of those which must be incorporated. It is interesting to find, therefore, that one of the foremost wireless firms has removed this objection to the portable once and for all by employing the superheterodyne circuit in their latest model.

The frame aerials for the two wavebands are wound on separate formers, and are much smaller than usual. The medium wave aerial is mounted in the upper compartment of the cabinet at the front of the chassis, whereas the long wave aerial is fixed to the lower half of the back, and, as a result, coupling between the two frames is kept at a minimum. This is a highly important point, for it prevents dead spots from being formed on the medium waveband, and in spite of the small aerials it may give greater average efficiency.

Signal-frequency Amplifier.

The frame aerial is tuned by one section of the three gang condenser, but an adjustable trimmer is fitted so that it may always be brought into exact resonance with the other circuits, and full efficiency and freedom from second channel interference secured. The first valve is a screen-grid signal-frequency H.F. amplifier, and it serves also to provide volume control, for a potentiometer is fitted to control its grid bias.

Tuned anode coupling is employed between the H.F. and first detector stages and another screen-grid valve, biased to act as an anode-bend detector and coupled to the oscillator by a pick-up coil in its grid circuit, is used for the latter. The oscillator itself is a triode valve with its anode circuit tuned to give minimum harmonic generation, and its grid biased negatively by means of a grid leak and condenser.

HIGHLY SELECTIVE AND ECONOMICAL PORTABLE RECEIVER.

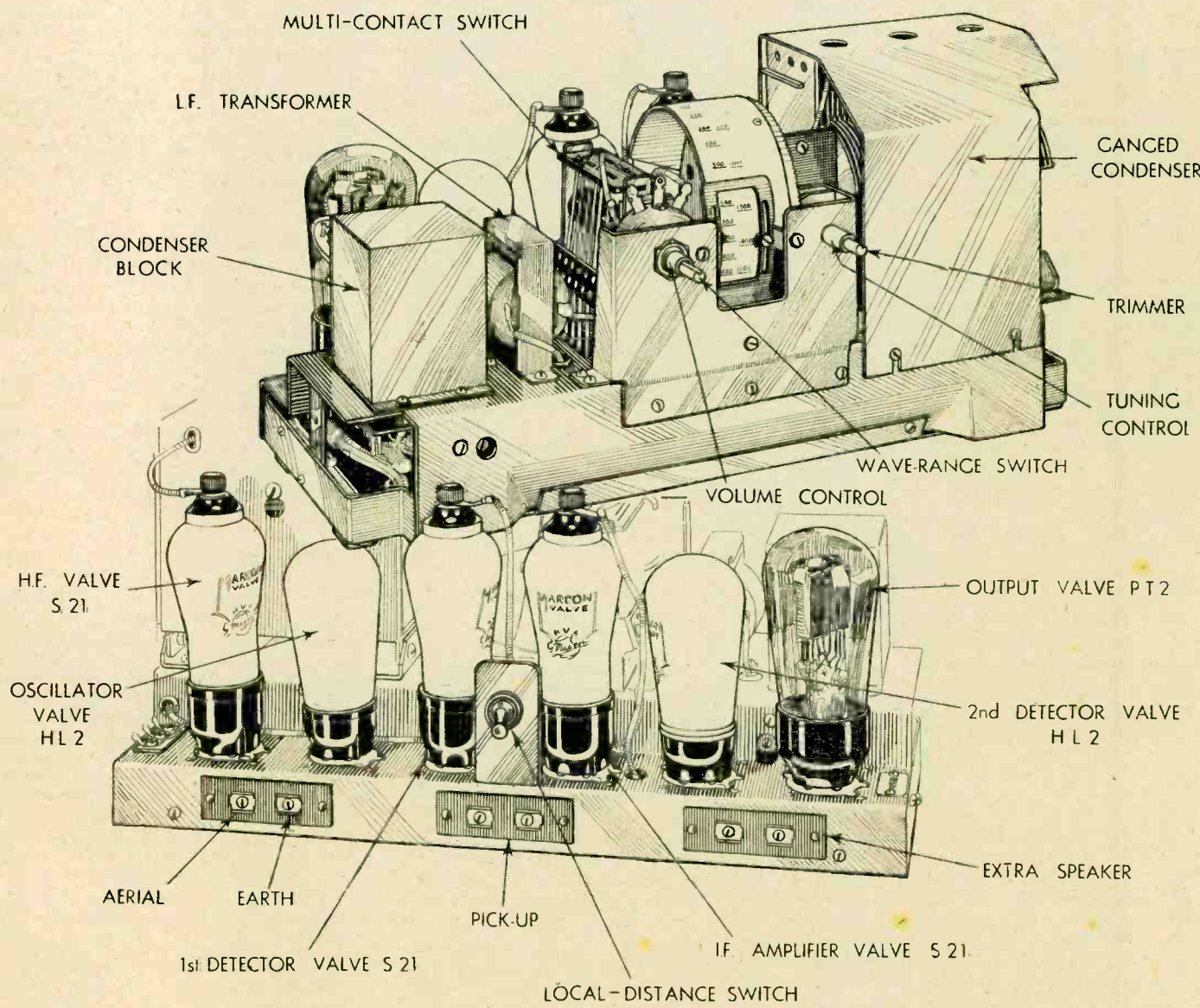
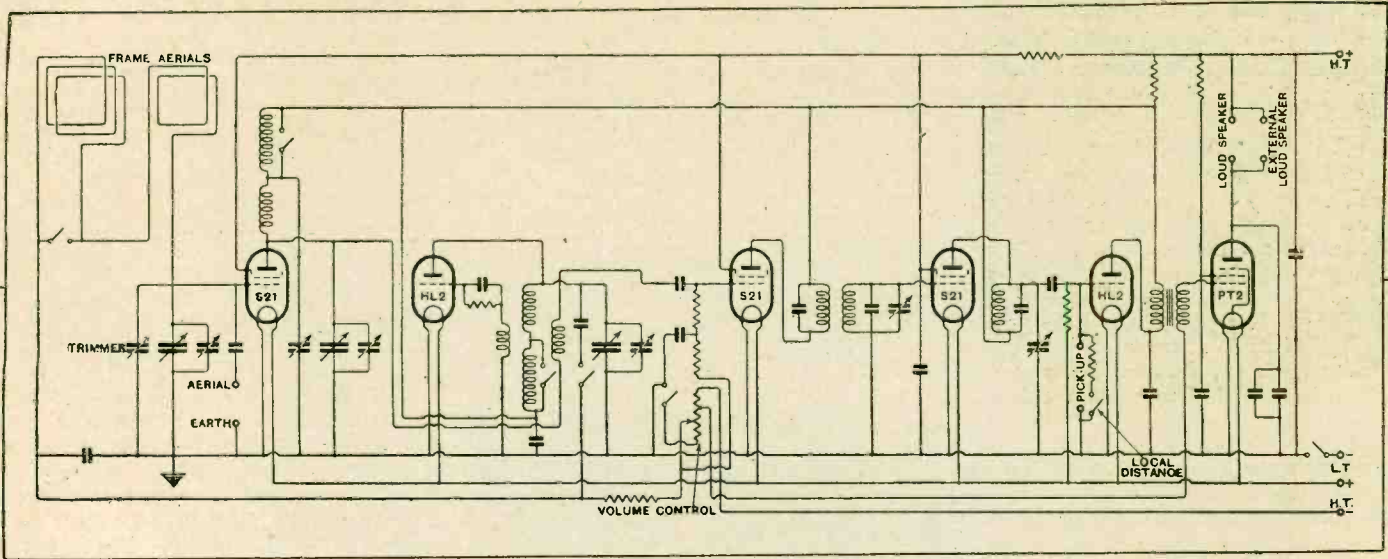

Circuit diagram and two views of the chassis of the H.M.V. six-valve portable superheterodyne.

Correspondence.

The Editor does not hold himself responsible for the opinions of his correspondents.

Correspondence should be addressed to the Editor, "The Wireless World," Dorset House, Tudor Street, E.C.4, and must be accompanied by the writer's name and address.

Dual Unit Loud Speakers.

IN view of the attention which has been directed recently to the commercial development of dual unit loud speakers, I think your readers may be interested in the accompanying photograph. This speaker was designed and built at the beginning of 1927 by Mr. E. Howard Robinson and myself on behalf of British Acoustic Films.

Our speaker, as the picture shows, consists of two complete units, one designed for the higher frequencies, and the other for the lower frequencies. The effective area of the smaller diaphragm is actually far smaller than would appear at first sight, as it is supported on a very large oiled silk surround. The diaphragm is probably one of the lightest which has ever been used, as it was made from extremely thin silk treated

used to get quite hot until a little redesign put matters right.

Another trouble was the connection of the coil to the diaphragm. A reinforced arrangement was eventually employed, which proved quite satisfactory, both acoustically and dynamically. A strengthened tube was used, which was slightly re-entrant, a special "cooked" celluloid base cement consolidating the joint on both sides

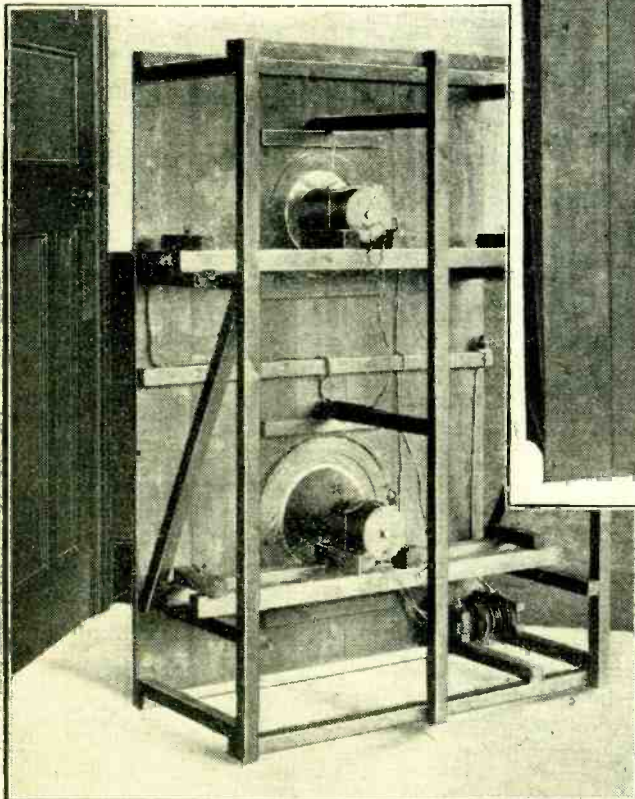

Two views of the dual unit loud speaker described by Mr. Tyers. The size of the complete assembly may be judged by comparison with the door on the left.

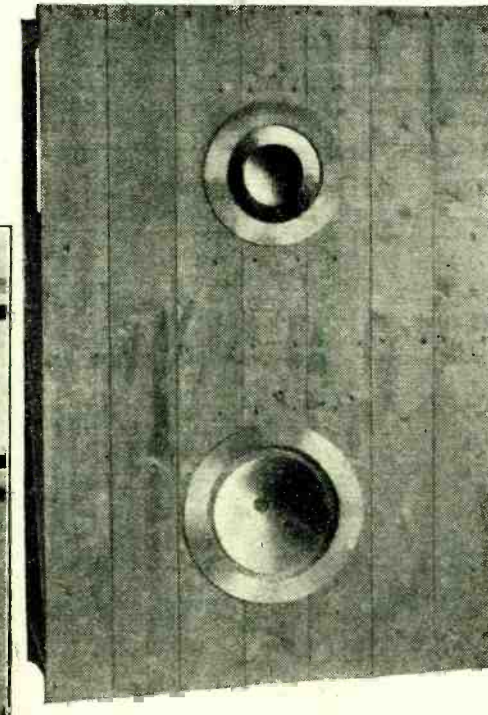

of the diaphragm. A very free diaphragm was used in both cases, and a little difficulty was experienced with the centring arrangement, a thread suspension system

actually being employed.

The special input transformer arrangement which was used can be seen at the base of the framework, the transformer being about as large as the field winding, a feature which seems rather amusing when compared with the diminutive little transformer riveted to the side of a popular moving-coil speaker chassis.

It is possible that our speaker was one of the first dual types, with the frequencies definitely split between two diaphragms, to be used in this country. It is even more interesting that Messrs. Hartley and Turner should have produced an almost identical arrangement from a theoretical point of view, although I expect their speaker differs in one or two details, as speaker technique has made very considerable advances during the five years which separate the two

speakers, and no doubt they have obtained a slightly better performance.

There is no doubt, however, that our speaker gave exceptionally good overall balance, and I still think that it was far superior to any single type which I have subsequently designed myself, or examined elsewhere. From a theoretical point of view, it is obvious that a dual speaker with a split frequency response is far easier to design than a single unit, which, by its very nature, seems to require diametrically opposite characteristics for good reproduction at each end of the frequency scale.

Watford.

PAUL D. TYERS.

The Wavelength Problem.

I HAVE read with interest Mr. Ashbridge's article on the wavelength problem.

There seems to be one fairly simple solution to the problem that he has overlooked, which is the elimination of one sideband, say the lower one, from the transmitted train.

This would, in effect, give double the separation between existing stations, and the only interference present would be the 9 kc. heterodyne whistle, which could be eliminated by a sharp cut-off at about 8,500 cycles. Obviously more pleasant than the advocated cut-off at 4,000 cycles.

It would seem to favour band-pass rather than Stenode methods of reception, and, incidentally, would eliminate any harmonic distortion due to non-linearity of the detector.

M. G. McBRIDE.

Henley-on-Thames.

A Plea for D.C. Sets.

ON my ramblings round the recent Radio Exhibition at Olympia, where I saw much of considerable interest, two facts were brought very forcibly home to me:—

- (1) The comparative dearth of all-mains sets suitable for direct current supply, and
- (2) The numerous enquiries which I found had been made for sets suitable for D.C.

Several stand attendants' first remarks to me were: "Now don't say you are on D.C.," and others, when I enquired for D.C. mains sets, showed distinct disappointment, and some remarked they had no idea there would be so many enquiries for this type of set, and all this happened during the early days of the Exhibition.

There does seem to be a prevailing idea amongst set manufacturers that the whole electricity supply in this country is rapidly being changed over to alternating current. As one directly connected with the electricity supply business—and also a keen radio enthusiast—I should like to state that although many districts have changed over from D.C. to A.C., it is my opinion that this process is now showing signs of slowing up.

To-day I believe some 50 per cent. of the electricity supply in this country is still D.C., and in these days of economic depression is likely to continue as such for some considerable time.

In view of the above-mentioned facts, and realising that *The Wireless World* is universally acknowledged as being first in the field with the latest and best in set designs, I crave your indulgence to consider the advisability of meeting a real want by publishing in your journal in the near future a circuit design for an all-mains D.C. set, incorporating the latest D.C. valves. Might I take the liberty of suggesting that such a set be of the radio-gramophone type, which was so much in evidence at the recent Exhibition.

If you concur with this suggestion I feel convinced you will earn the gratitude of numerous direct current radio enthusiasts.

Aberdeen.

A. H. MCKAY.

Automatic Gain Control.

Part 2.—The Use of the Wunderlich Valve.

By A. DINSDALE.

IN Part I of this article the principles underlying the various systems of automatic volume control were explained, and reference was made to the Wunderlich valve. Fig. 5 shows a 6-valve superheterodyne circuit employing this valve and the AGC system. Although the valve is not available in England, unless imported from America, there are certain advantages in including the full circuit in this article. In the first place it enables the reader to obtain a more comprehensive idea of the application of the principles which have just been discussed. Secondly, an examination of the circuit will reveal the circuit simplification which is possible with the new valve. Thirdly, there is obvious scope for experimenters to secure similar results by using two carefully matched triodes connected in push-pull to replace the Wunderlich valve. In attempting to do this, it should be remembered that any unbalance in the input grid circuits will cause high-frequency currents to flow in the anode circuits, which, in turn, will reduce the available output power of the combination, since, from the point of view of L.F. amplifier action, only a certain A.C. voltage can be handled on the grids. The more perfect the balance can be made at the input circuit the higher will be the detector efficiency and the better will be the AGC bias voltage.

A study of Fig. 5 will reveal the following deviations from common superhetero-

dyne practice. The coils of the H.F., 1st Det., and I.F. stages are insulated from earth by means of by-pass condensers; their value is 0.05 mfd. If a larger capacity is used it will require that much longer to charge and discharge, thus slowing up the time-constant of the AGC action. By using a condenser as large as 0.25 mfd. the delay may be so great as to allow the set to be tuned from one local station to another before the set returns to full sensitivity. The value of 0.05 mfd., however, is about right for practical purposes and, with the type of circuit shown, gives a time-constant of about one-twentieth of a second.

Overloading the I.F. Valve.

When the H.F., 1st Det., and I.F. valves are all connected to the common AGC lead a 0.5 megohm resistance should be inserted in the lead to the 1st Det. grid coil to act as a filter from the circuit to that of the other two valves. None is required between the H.F. and I.F. because of the difference in operating frequencies.

It is apparent that in a receiver with automatic control of sensitivity, where all incoming signals are amplified to obtain the same detector input voltages, regardless of the strength of the signal at the aerial, it is most desirable to have as much of the total receiver gain *ahead* of detection as possible. The greater this

gain ahead of demodulation the greater will be the latitude of automatic control action. Therefore, every attempt should be made to use as much amplification as possible preceding the detector. Various methods can be employed. The maximum H.T. voltage should be applied to *all* of the amplifiers. The LC ratio of the I.F. transformers should be high and proper coupling maintained. An inductance of about 10 mh. is right for a transformer tuned to 175 kc.

Very strong signals from local stations may cause overloading of the I.F. valve, often mistaken for detector overload. A very strong signal, particularly if there is no automatic control on the first detector, may force the I.F. plate voltage down to a point equal to that of the screen voltage, where bad distortion and partial cut-off will be experienced. Such a condition exemplifies the value of the local-distance switch, with which many American receivers are equipped. This switch generally effects a reduction in the number of active turns in the aerial primary coil.

In many receivers the cathodes of the H.F. and I.F. valves are returned to earth through the manual volume-control variable resistance and then a small fixed resistance which determines the initial bias for these valves. In the circuit shown in Fig. 5 the manual volume control is placed after the second detector, at the input to the power stage. Since full sensi-

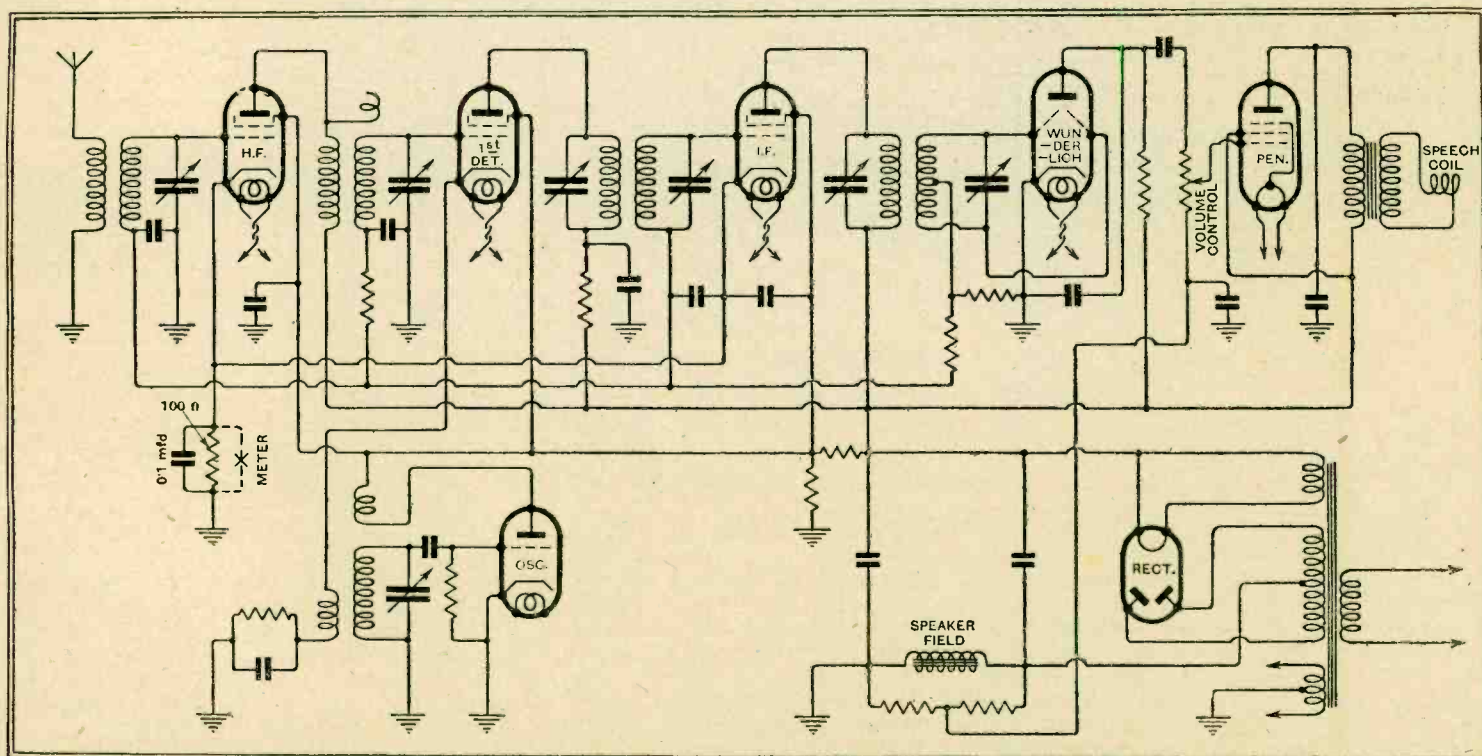

Fig. 5.—Circuit diagram of a complete six-valve superheterodyne embodying the Wunderlich valve and an AGC system.

Automatic Gain Control.

tivity is wanted, the volume control is not fitted to the bias circuit. It is likewise best to reduce the value of the H.F. and I.F. bias resistance to about 100 ohms (this is an average value) as there is always a slight bias coming along the AGC lead as a result of circuit-hiss, and with no signal the two add up to about 3 volts for initial bias. A 0.1-mfd. condenser is used to by-pass the 100-ohm resistance.

If it is desired to fit a tuning meter to aid in determining when the receiver is tuned to resonance, an inexpensive milliammeter serves admirably, and if the resistance of the coil within the meter is made 100 ohms it can be fitted in place of the 100-ohm resistance. The meter should be by-passed with a 0.1-mfd. condenser. Such a meter, having a range of 0.5 mA., is extremely useful as an aid to tuning, especially to non-technical members of the public. An ordinary receiver can be tuned fairly easily by an inexperienced person by simply tuning for the loudest signal. But when the receiver is equipped with AGC it becomes much more difficult to find the resonance point, because when that point is passed and signal strength tends to fall the AGC comes into action and restores the output level of the speaker, and maintains it over an appreciable portion of the tuning dial. Distortion and background noise immediately begin to set in, of course, as the resonance point is departed from, but, as the process is gradual, the best performance of the set is often missed. Hence, some form of visual tuning indicator becomes almost a necessity.

It will be observed in Fig. 5 that there is a condenser (0.00025 mfd.) connected between the plate and earth of the Wunderlich valve. The purpose of this is to by-pass any slight amount of H.F. current which may be present in the plate circuit due to small degrees of unbalance in the input circuit.

Economy of Apparatus.

The characteristics of this valve and system are such that an appreciable load is not imposed upon the tuned circuit. The reflected load is, in fact, approximately 1 megohm. From a commercial manufacturing standpoint it is claimed that no extra cost is added to the receiver chassis; on the contrary, it is possible to save one or two valves and still obtain the same overall performance, due to the higher operating efficiency of the H.F. stages. Further saving in chassis cost is effected by the elimination of resistances and condensers used on standard types of detector cathode and screen. Cathode-biasing resistances and condensers for the radio stages are not required. Some fourteen leading American set manufacturers, and one of the largest in Canada, have incorporated the valve in their new models.

Before closing this article it may be of interest to describe briefly still another system of AGC which operates on a totally different principle. This system was in-

vented and patented in the United States by George E. Fleming, a capable young engineer who was formerly Technical Editor of *Radio News*.

Put briefly, Fleming utilizes the change in current in the detector-anode circuit to

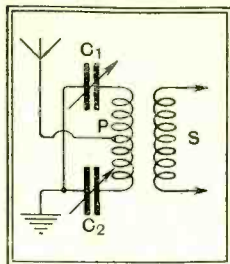

Fig. 6.—The balanced aerial circuit used in the Fleming AGC scheme.

detune mechanically a balanced aerial-input circuit. In an aerial circuit arrangement such as that shown in Fig. 6, if the condensers C_1 and C_2 are adjusted to perfect balance, there will be no transfer of H.F. energy from the primary P to the secondary S. If one of the condensers, say C_1 , is unbalanced, the energy transfer will be proportional to the degree of unbalance.

Fleming takes advantage of this condition in the following manner: Referring to Fig. 7, there is connected in the output circuit of the detector valve, between the anode and the primary of the first L.F. transformer, a variable resistance R. Connections are taken from this resistance, as shown, to the winding of a sensitive galvanometer, the needle of which is mechanically coupled to the movable plate of the 3-plate midget condenser C_1 , which corresponds to C_1 in Fig. 6.

By pre-setting manually the variable tapping on resistance R, the degree of swing, or unbalance of C_1 , can be controlled, and the device functions in such a manner that loud speaker volume can never exceed the predetermined level, even if the receiver is tuned through a powerful local station.

Galvanometer Scheme.

The circuit arrangements shown in Figs. 6 and 7 need not be adhered to rigidly; considerable modification is permissible to meet the requirements of the circuits of existing receivers which it is not desirable to disturb too greatly. The amount of energy required to operate the galvanometer naturally depends upon the design of the galvanometer; the inventor's existing experimental model gives a full-scale deflection on a maximum current

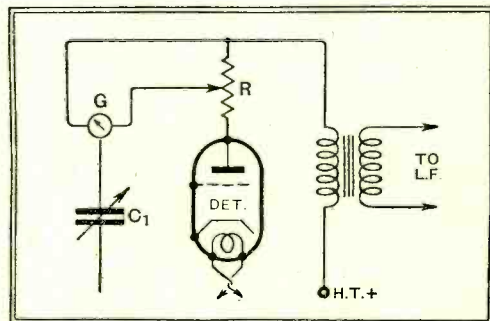

Fig. 7.—Method of application of the Fleming system of AGC. G is a sensitive galvanometer.

range of 1 mA. Some form of light damping of the galvanometer and condenser plate swing is desirable to prevent excessive mechanical oscillation.

In conclusion, it is claimed by one American manufacturer that practically every radio receiver in the future will have an overall sensitivity of the order of 5 microvolts or better. It is not only reasonable, he states, but necessary to apply to these receivers some method of control which will adequately deal with the signal inputs encountered in practical operation, ranging all the way from five microvolts to one million microvolts. Which sounds reasonable enough in a land where a few valves more or less are a mere detail of design and cost only three or four shillings apiece for replacement.

Occasional Instability.

NO set should be considered to be really stable if there is the slightest tendency for it to oscillate when the aerial and earth are removed. Where possible this test should always be applied to a receiver which it is intended to purchase. It is a perfectly fair test to make, for no set which depends upon aerial load for its stability should be tolerated in these enlightened days. If a modern receiver oscillates when the aerial and earth are removed the trouble is often traceable to insufficient screening, and it is justifiable to suspect that, if this is so, other parts of the receiver may reveal similar evidence of unsound design.

NEW READERS' NUMBER.

Next week's issue of *The Wireless World* will be devoted largely to the hosts of newcomers who have joined the ranks of our regular readers.

Each copy will contain also, as a free supplement,

A NEW FOREIGN STATION TUNING CHART

simplifying the task of finding the most elusive transmitters.

The issue will include, in addition to the usual features and special articles for the less advanced reader, constructional details of a highly selective

4-valve Battery Superheterodyne Receiver

consuming only 10 to 13 mA anode current. Practical articles on how to obtain greater selectivity from existing sets will also appear.

Broadcast Brevities.

By Our Special Correspondent.

"You May Broadcast from Here."

"TELEPHONE box facilities" is the stock name for the arrangement now subsisting between the broadcasting organisations of Europe to enable distinguished foreign visitors to broadcast to their native countries. Broadcasting officials, who are the most obliging people on earth, seem ever ready to lend a studio, and even an announcer, to anyone who "drops in," and whose credentials are satisfactory.

Mr. Vernon Bartlett will make extensive use of the system during his forthcoming tour of the European capitals, beginning with Paris on October 20th. The others on his list of fortnightly "visits" are Berlin, Prague, Vienna, Budapest, and Rome.

The Line from Paris.

If Mr. Bartlett were going to sing to us in the Gay City we should probably notice that the cables from Paris to London *via* Poix, Boulogne, and Canterbury are definitely inferior to those linking us with the central European cities. However, they will serve Mr. Bartlett's purpose, though it is good to know that new and better cables are shortly to be installed on the London-Paris route. This may open up prospects of regular musical relays from the French capital.

Berlin and Beyond.

When in Berlin and the cities beyond, Mr. Bartlett will be speaking over the excellent new line which follows the Frankfurt and Leipzig route to Brussels and thence to La Panne (on the Belgian coast), Canterbury, and the G.P.O. trunk terminals at St. Martin's-le-Grand. This line will cope with most of the frequencies that Mr. Bartlett can give us; as listeners know, it supplies excellent reproduction of symphony orchestras and choirs as far away as Austria.

Sunday Talks to America.

America has for a long time availed herself of the telephone box facilities offered by the B.B.C., and I hear that a new Sunday evening series of talks by important people for the benefit of listeners on the Columbia broadcasting system will begin on Sunday, October 9th, when Mr. J. A. Spender will "borrow" a B.B.C. studio, with announcer, to talk on "American Principles and European Policy."

Perhaps "borrow" is the wrong word, for the B.B.C. makes a small charge and the announcer is given his out-of-pocket expenses.

Not for Our Ears.

These talks, of course, go out *via* Rugby Radio, and to hear them the British listener must either pick up America direct or smuggle himself into Broadcasting House.

Belfast Station on Divis.

ONE point in connection with the site for the new Belfast transmitter of the B.B.C. has been definitely settled. It will be somewhere on the beautiful Divis Hill, 1,560ft. high, which dominates the city from four miles inland. I hope that the

B.B.C., who so frequently remind us not to spoil the countryside with waste paper, will not spoil the view of Divis with masts on the skyline.

Working Next Year.

The Belfast transmitter will amount to half a Regional station. It will operate on only one wavelength, but in other respects will follow Regional scheme practice. Despite pleas for "plenty of power," it will not carry more than 50 kilowatts in the aerial as the B.B.C. engineers feel that anything in excess of this power would be wasted over the sea. The wavelength will probably be in the neighbourhood of 350 metres. It is quite probable that the new station will be in operation twelve months hence.

The Camera Man and the Cat.

PRESS photographers continue to smart under the regulation forbidding them to take pictures within Broadcasting House. One of their number the other day nearly brought off a *coup* and was only frustrated by the presence of mind of a B.B.C. commissioner. The photographer had hoped



BRIGHTER NEWS. Dr. Rausch, the German broadcast news editor, made valiant attempts to improve the news bulletins by first "trying them on the dog"—i.e., the dictaphone. His resignation was reported last week.

to present the public with a graphic view of the ejection from Broadcasting House of the famous cat which recently contributed a meow to the Sunday evening concert. He actually took an animal under his arm to the doors of "B.H." and, flinging it into the entrance hall, quickly retired in the hope that a moment later he would get a first-class snap of the commissioner kicking it out. Unfortunately a watchful "official" instantly perceived the plan, and ejected, not the cat, but the photographer!

Good Work.

MY congratulations to a fellow-journalist on scoring his best "scoop." In between story-getting and interviewing the mighty at Broadcasting House he has won the hand of a fair young lady in the Press Section, and the nuptials are being celebrated this week.

Projecting the Shires.

THE new "County" series of programmes from Midland Regional promises to be a great success.

Worcestershire will hold the stage from October 17th to 22nd. The little festival will include an historical pageant written by Mr. F. B. Andrews, President of the Birmingham Archaeological Society, the opening of the New Bridge at Worcester by H.R.H. the Prince of Wales, and relays from factories dotted up and down the county. Derbyshire will be featured from October 31st to November 5th. Mr. L. Du Gard Peach has written the historical pageant, and the Sherwood Foresters' Band will contribute characteristic music. There will also be a play in the Derbyshire dialect. Herefordshire follows from November 21st to 26th with its own historical pageant, a choral concert from the Shire Hall, Hereford, and a dialect play. Later on Lincolnshire will be portrayed.

Technical Talks for Listeners.

SOME of the elementary problems which perplex the listener are to be dealt with by Mr. Watson Watt, Superintendent of the Radio Research Board station, and Mr. O. F. Brown, Secretary of the Board, in a series of seven broadcast talks from the National transmitters. The first will be on October 8th at 7.5 p.m., and subsequent talks will be given on Saturdays at fortnightly intervals.

Thoughts at the "Proms."

I HAVE stood beneath the microphones in the arena of the Queen's Hall, and I have sat on cushions in the grand circle above, but it is only from the latter vantage point that one fully appreciates the stubborn spirit that keeps the promenaders on their feet from 8 to 10.30.

Yesterday I was a promenade myself; to-day, thanks to the loan of a white ticket, I look down upon the poor wretches as they sway with an uncanny unanimity, like so many poppyheads.

To-morrow—the last night of the season—I shall be back on the floor.

Amazing Sir Henry.

Besides the happy conglomeration of musical memories which one takes away from the season of Prom. concerts now closing, there is the recollection of that increasingly astonishing phenomenon: the energy of Sir Henry Wood.

Each year this veteran conductor—yes, "veteran," you would scarcely believe it—seems twelve months younger than when he conducted the National Anthem at the conclusion of the previous season.

With apologies to another, "Here's to the next time, Sir Henry!"

Bulletins for Babies?

PEOPLE living in outlying places where no kind of news reaches them until they are at least twenty-four hours old found in radio news broadcasting a blessing which they can ill afford to lose.—*Indian Wireless Magazine*, Calcutta.

READERS' PROBLEMS.

THESE columns are reserved for the publication of matter of general interest arising out of problems submitted by our readers. Readers requiring an individual reply to their technical questions by post are referred to "The Wireless World" Information Bureau, of which particulars, with the fee charged, are to be found below.

Which Tapping?

WHEN it happens that none of the primary tapping terminals of a power transformer is marked with a voltage corresponding precisely to that of the supply, there is a natural uncertainty as to which point the mains lead should be connected. Should it be joined to the next higher or the next lower terminal when both differ by an equal amount from the mains voltage?

This, in effect, is the question put to us by a reader, whose transformer has tapings for 230 and 250 volts; the rated pressure of his main is 240 volts. He adds that he wishes to be "on the safe side."

If by this proviso we can assume that it is desired that the output voltages shall all be on the low side, then it is correct to use the higher voltage terminal.

This is really not a matter of very great importance, but it is useful to remember, if the mains voltage is known to be usually on the high side, that this may be corrected by making use of one of the higher voltage tapings. The converse also applies.

Free Bias for Battery Sets.

APPARENTLY inspired by the present tendency among commercial set designers to abolish grid bias cells in battery-operated receivers, a number of readers have asked for information as to how this alteration may be made to their existing receivers.

Space does not permit of a treatment of each individual case, but fortunately the principle is the same with every type of circuit. Unlike automatic bias arrangements for mains-operated receivers, we have practically no choice as to the scheme to be adopted. The almost universal practice is to insert the resistor across which bias potentials are developed in the lead between the negative side of the H.T. battery and the L.T. negative bus-bar. Matters are so arranged that the voltage drop across the resistance is equal to the maximum bias voltage required; intermediate voltages for valves requiring less than the maximum are "tapped-off" the resistance.

This is illustrated in Fig. 1(a), where a two-stage resistance-coupled amplifier is taken as an example. Instead of using a single resistance with a tapping, two separate resistances are shown, as this course is generally more convenient.

The first step in estimating the value of these resistances is to calculate their combined resistance by dividing "maximum bias voltage required" by "total anode current." Next, the value of R_1 is ascertained by repeating this calculation, but with the substitution of "bias voltage required for the L.F. valve" for "maximum bias voltages required." Having thus calculated the

value of R_1 , that of R is given by simple subtraction.

This may appear to be slightly complex, but an example will show that the matter is simple enough. Let us assume that the set shown in Fig. 1 consumes a total of 15 milliamps, and that the recommended bias voltages for the L.F. and output valves are respectively 3 and 10 volts. The total bias resistance needed will therefore be $10 \div 0.015 = 666$ ohms approximately. The

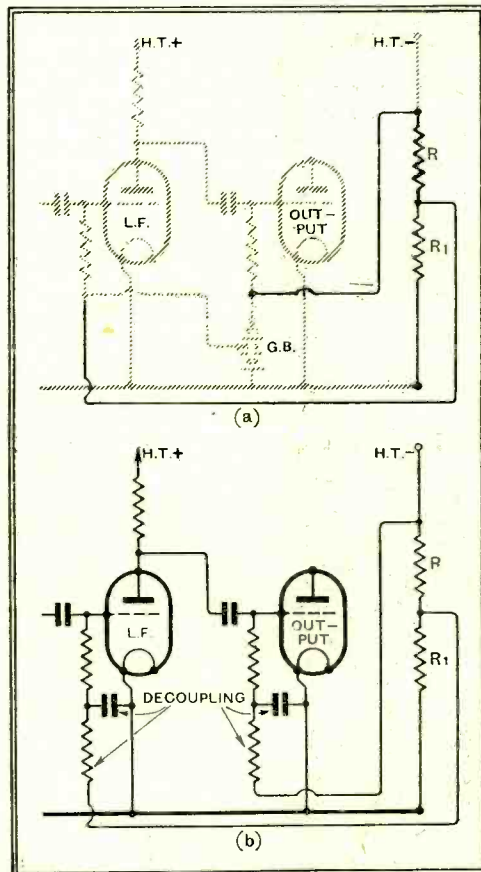

Fig. 1.—The principles of automatic bias applied to battery sets. Diagram (a) shows the essentials of the conventional method; the superseded battery bias connections are in dotted lines. In diagram (b), decoupling has been added to the same circuit.

figures relating to R_1 are $3 \div 0.015 = 200$ ohms. Thus R_1 must be 200 ohms, and so R must have a value of $666 - 200 = 466$ ohms. A standard resistor of 500 ohms would do.

Decoupling may or may not be needed, depending upon the receiver to which the addition of automatic bias is being made. Generally, it will be necessary to include it, and appropriate connections are shown in diagram (b). The decoupling condensers and resistances shown may have values of 1 mfd. and 50,000 ohms respectively.

Kismet!

IT would seem that there are still in existence a number of what we generally refer to as "valve makers' benefit circuits." At any rate, we still receive tales of woe describing the untimely destruction of all the valves in a receiver, due, say, to an accidental contact between the H.T. positive terminal of the battery and a metal screen.

A correspondent whose letter we have in mind adopts the fatalistic attitude that this state of affairs is inevitable; actually, it is not, and, indeed, it is quite a difficult matter to burn out all the valve filaments of a properly arranged set, even by deliberately introducing all the possible short-circuits that might take place accidentally.

These accidents are almost invariably caused by an incorrect method of H.T.-L.T. interconnection, sometimes combined with an incorrect arrangement of the on-off switch, and wrong connections between batteries and screen. To be on the safe side, one has only to adopt the method of connection which is invariably shown in our published circuit diagrams.

The Monodial Oscillator.

AFTER working satisfactorily for some time, the "Monodial A.C. Super" constructed by a reader has suddenly failed. As a result of carrying out systematic tests with the help of a milliammeter, he has localised the fault in the oscillator valve, which is no longer producing the necessary oscillations. Having narrowed down the search thus far, our reader asks us to suggest the most likely causes of this state of affairs.

We assume that the oscillator coil windings have already been tested for continuity, but would point out that it is also as well to search for a short-circuit across any one of the sections. Care should also be taken to see that the oscillator coil screen is not touching the terminal of the oscillator section of the ganged condenser; of necessity, the clearances between these parts is but small. Incidentally, any short-circuit across this section of the tuning condenser would prevent the generation of oscillations.

A failure in the feed condenser C_{10} , or in the grid by-pass condenser C_{11} , would have a similar effect, and so the condition of these components should be checked as carefully as possible, particularly for insulation and continuity between the terminals and the plates; extreme accuracy in capacity value is not so important.

There is the possibility of a faulty oscillator valve, or of a faulty contact between the valve pins and their sockets. Lastly, the condition of the resistances R_2 and R_3 should be checked.

The Wireless World INFORMATION BUREAU.

THE service is intended primarily for readers meeting with difficulties in the construction, adjustment, operation, or maintenance of wireless receivers described in *The Wireless World*, or those of commercial design which from time to time are reviewed in the pages of *The Wireless World*. Every endeavour will be made to deal with queries on all wireless matters, provided that they are of such a nature that they can be dealt with satisfactorily in a letter.

Communications should be addressed to *The Wireless World* Information Bureau, Dorset House, Tudor Street, E.C.4, and must be accompanied by a remittance of 5s. to cover the cost of the service. The enquirer's name and address should be written in block letters at the top of all communications.